



BIRD VECTOR NETWORK ANALYZER
BNA 100
BNA 1000

OPERATION MANUAL

Safety Precautions

The following are general safety precautions that are not necessarily related to any specific part or procedure, and do not necessarily appear elsewhere in this publication. These precautions must be thoroughly understood and apply to all phases of operation and maintenance.

WARNING

Keep Away From Live Circuits

Operating Personnel must at all times observe general safety precautions. Do not replace components or make adjustments to the inside of the test equipment with the high voltage supply turned on. To avoid casualties, always remove power.

WARNING

Shock Hazard

Do not attempt to remove the RF transmission line while RF power is present.

WARNING

Do Not Service Or Adjust Alone

Under no circumstances should any person reach into an enclosure for the purpose of service or adjustment of equipment except in the presence of someone who is capable of rendering aid.

WARNING

Safety Earth Ground

An uninterruptible earth safety ground must be supplied from the main power source to test instruments. Grounding one conductor of a two conductor power cable is not sufficient protection. Serious injury or death can occur if this grounding is not properly supplied.

WARNING

Resuscitation

Personnel working with or near high voltages should be familiar with modern methods of resuscitation.

WARNING

Remove Power

Observe general safety precautions. Do not open the instrument with the power on.

Safety Symbols

WARNING

Warnings call attention to a procedure, which if not correctly performed, could result in personal injury.

CAUTION

Cautions call attention to a procedure, which if not correctly performed, could result in damage to the instrument.



This symbol indicates that a shock hazard exists if the precautions in the instruction manual are not followed.



The caution symbol appears on the equipment indicating there is important information in the instruction manual regarding that particular area.



This symbol indicates that the unit radiates heat and should not be touched while hot.

NOTE

Notes call attention to supplemental information.

Warning Statements

The following safety warnings appear in the text where there is danger to operating and maintenance personnel, and are repeated here for emphasis.

WARNING

Outlets must match the supplied AC plug, never modify the plug in any way. Do not use any adapter plugs with grounded components. If the plug will not fit the outlet, have a proper outlet installed and grounded by a qualified electrician in accordance with all codes and ordinances. Standardized, grounded plugs and outlets reduce risk of electric shock, serious injury, or death.

See pages 7.

Caution Statements

The following equipment cautions appear in the text and are repeated here for emphasis.

CAUTION

**Do not exceed the maximum input power +23dBm RF, 35 VDC.
Take precaution to avoid static discharge into the Bird VNA.**

See pages 8.

Safety Statements

USAGE

ANY USE OF THIS INSTRUMENT IN A MANNER NOT SPECIFIED BY THE MANUFACTURER MAY IMPAIR THE INSTRUMENT'S SAFETY PROTECTION.

USO

EL USO DE ESTE INSTRUMENTO DE MANERA NO ESPECIFICADA POR EL FABRICANTE, PUEDE ANULAR LA PROTECCIÓN DE SEGURIDAD DEL INSTRUMENTO.

BENUTZUNG

WIRD DAS GERÄT AUF ANDERE WEISE VERWENDET ALS VOM HERSTELLER BESCHRIEBEN, KANN DIE GERÄTESICHERHEIT BEEINTRÄCHTIGT WERDEN.

UTILISATION

TOUTE UTILISATION DE CET INSTRUMENT QUI N'EST PAS EXPLICITEMENT PRÉVUE PAR LE FABRICANT PEUT ENDOMMAGER LE DISPOSITIF DE PROTECTION DE L'INSTRUMENT.

IMPIEGO

QUALORA QUESTO STRUMENTO VENISSE UTILIZZATO IN MODO DIVERSO DA COME SPECIFICATO DAL PRODUTTORE LA PROIZIONE DI SICUREZZA POTREBBE VENIRNE COMPROMESSA.

SERVICE

SERVICING INSTRUCTIONS ARE FOR USE BY SERVICE - TRAINED PERSONNEL ONLY. TO AVOID DANGEROUS ELECTRIC SHOCK, DO NOT PERFORM ANY SERVICING UNLESS QUALIFIED TO DO SO.

SERVICIO

LAS INSTRUCCIONES DE SERVICIO SON PARA USO EXCLUSIVO DEL PERSONAL DE SERVICIO CAPACITADO. PARA EVITAR EL PELIGRO DE DESCARGAS ELÉCTRICAS, NO REALICE NINGÚN SERVICIO A MENOS QUE ESTÉ CAPACITADO PARA HACERLO.

WARTUNG

ANWEISUNGEN FÜR DIE WARTUNG DES GERÄTES GELTEN NUR FÜR GESCHULTES FACHPERSONAL.

ZUR VERMEIDUNG GEFÄHRLICHE, ELEKTRISCHE SCHOCKS, SIND WARTUNGSARBEITEN AUSSCHLIEßLICH VON QUALIFIZIERTEM SERVICEPERSONAL DURCHZUFÜHREN.

ENTRETIEN

L'EMPLOI DES INSTRUCTIONS D'ENTRETIEN DOIT ÊTRE RÉSERVÉ AU PERSONNEL FORMÉ AUX OPÉRATIONS D'ENTRETIEN. POUR PRÉVENIR UN CHOC ÉLECTRIQUE DANGEREUX, NE PAS EFFECTUER D'ENTRETIEN SI L'ON N'A PAS ÉTÉ QUALIFIÉ POUR CE FAIRE.

ASSISTENZA TECNICA

LE ISTRUZIONI RELATIVE ALL'ASSISTENZA SONO PREVISTE ESCLUSIVAMENTE PER IL PERSONALE OPPORTUNAMENTE ADDESTRATO. PER EVITARE PERICOLOSE SCOSSE ELETTRICHE NON EFFETTUARRE ALCUNA RIPARAZIONE A MENO CHE QUALIFICATI A FARLA.

About This Manual

This manual covers the operating and maintenance instructions for the following models:

BNA100

BNA1000

Changes to this Manual

We have made every effort to ensure this manual is accurate. If you discover any errors, or if you have suggestions for improving this manual, please send your comments to our Solon, Ohio factory. This manual may be periodically updated. When inquiring about updates to this manual refer to the part number and revision on the title page.

TABLE OF CONTENTS

Safety Precautions	i
Safety Symbols	ii
Warning Statements	iii
Caution Statements	iv
Safety Statements	v
About This Manual	vii
Changes to this Manual	vii
Chapter 1 Introduction	1
Unpacking and Inspection	1
General Description	1
BNA100 VNA	1
BNA100 VNA Optional Items	1
BNA1000 VNA	2
BNA1000 VNA Optional Items	2
BNA100 VNA Front Panel Description	3
BNA100 VNA Rear Panel Description	4
BNA1000 VNA Front Panel Description	5
BNA1000 VNA Rear Panel Description	6
Chapter 2 Setup	7
Graphical User Interface Software	7
Software Installation	7
Bird VNA Operating Power Connection	7
BNA100 VNA	7
BNA1000 VNA	7
Start Up	8
Measurement Steps	8
Chapter 3 User Interface Introduction	9
User Interface Description	9
Configuration/Control Menus	9
Function Menu	10
Display Area	11
Data Entry Bar	13
Instrument Status Bar	13

Chapter 4 Measurement Conditions	14
Restore Factory Default Settings	14
Calibration/System Z0	14
Channel and Trace Setup	15
Number of Channels and Layout	15
Number of Traces and Layout	16
Active Trace	17
Stimulus	18
Sweep Type	18
Sweep Range	19
Power	21
CW Freq	22
RF Out	23
Points	24
Measurement Delay	25
Measurement	26
S-Parameter Measurement	26
Absolute Power Measurement	27
Format	29
Rectangular	29
Polar Coordinate	29
Smith Chart	29
Scale	30
Auto Scale	30
Adjust the Cartesian Scale Manually	30
Adjust the Polar Plot and Smith Chart Scale	31
Other Scale Parameter Settings	32
Display	33
Trace Data Presentation Operations	33
Title	34
Update	35
Chapter 5 Calibration Types And Procedures	36
Channel Error Correction Status	36
Trace Calibration Status Indicator	37
Calibration Process	38

Open-circuit Response Calibration	39
Short-Circuit Response Calibration	40
Through Response Calibration	41
Full 1-Port Calibration	42
Enhance Response (Single Channel 2 Port Calibration)	43
Full 2-Port Calibration	44
Chapter 6 Triggered Measurement Setup	47
Select the Trigger Source	47
Set the Trigger Mode	48
Trigger Restart Control	48
Chapter 7 Measurement Analysis	49
Markers	49
Marker Overview	49
Marker Display	49
Marker Operation	50
Add Marker	50
Delete Marker	50
Reference Marker	51
Modify the Marker Position Value	51
Marker Search	52
Marker Function	60
Limit Test	65
Ripple Test	68
Time Domain Analysis	71
Chapter 8 Data Output	74
Saving Data/Settings	74
Data Retention Category	74
Save State	75
Save Channel	76
Save Trace Data	77
Save Data Touchstone	78
Recall Saved Data	79
Recall Saved State	79
Recall Saved Channel	80
Delete State	81

Delete All States	81
Chapter 9 Measurement Optimization	82
Expand the Dynamic Range	82
Reduce IF Bandwidth	82
Open the Average Scan Average	82
Reduce Trace Noise	83
Improve the Accuracy of Phase Measurement.....	83
Electrical Delay	83
Phase Offset.....	83
Increase the Measurement Speed.....	84
Closing the Update of Display Information.....	84
Offset Error Correction	84
Segment	84
Definition of Segmentation Tables	85
Execution of Segmented Scans.....	87
SYSTEM FUNCTIONS	88
Print Function	88
System Setting	90
SET PARAMETERS AND RANGE.....	94
Limited Warranty	95

Unpacking and Inspection

1. Carefully inspect shipping container for signs of damage.
 - If the shipping container is damaged, do not unpack the unit. Immediately notify the shipping carrier and Bird Technologies.
 - If the shipping container is not damaged, unpack the unit. Save shipping materials for repackaging.
2. Inspect unit for visual signs of damage.

NOTE

If there is damage, immediately notify the shipping carrier and Bird Technologies.

General Description

The Bird Vector Network Analyzers (VNA) are available in multiple frequency ranges, form factors, and capabilities as shown in the tables below.

BNA100 VNA

Table 1 BNA100 Compact USB VNA Models

Model Number	Frequency Range	Test Ports	RF Connectors	Dimensions
BNA100-2P6G5	300 kHz to 6.5 GHz	2	Type N(f)	6.9 in x 2.6 in x 11.5 in (175 mm x 65 mm x 292 mm)
BNA100-2P8G5	300 kHz to 8.5 GHz			

Items Included with the Unit

- USB-B to USB-A Cable, 1 m
- 1 GB USB Flash Drive with software installer
- AC/DC Adapter, 100-240 VAC, 50/60 Hz, 1.5 Amp input; 12 VDC, 3 Amp output

BNA100 VNA Optional Items

Options

- BNA1000-010, Time Domain
- BNA1000-1F5, Fixture circuit simulation function

Calibration Modules

- E285A, Electronic calibration module, 2 ports, 100 kHz to 8.5 GHz, 3.5 mm (f)
- E285C, Electronic calibration module, 2 ports, 100 kHz to 8.5 GHz, N(f)
- SK-CAL-NF-90, Calibration Kit, SOLT, DC to 9 GHz, N(f)
- SK-CAL-NM-90, Calibration Kit, SOLT, DC to 9 GHz, N(m)
- SK-CAL-SMAF-90, Calibration Kit, SOLT, DC to 9 GHz, SMA(f)
- SK-CAL-SMAM-90, Calibration Kit, SOLT, DC to 9 GHz, SMA(m)

RF Cables

- T5-RFCAB-NMNM-90101, Test Cable, 1m, DC to 9 GHz, N(m) to N(m)
- T5-RFCAB-NMSMAM-90102, Test Cable, 1m, DC to 9 GHz, N(m) to SMA(m)

BNA1000 VNA

Table 2 BNA1000 USB VNA Models

Model Number	Frequency Range	Test Ports	RF Connectors	Dimensions
BNA1000-4P6G5	300 kHz to 6.5 GHz	4	Type N (f)	18.8 in x 21.5 in x 4.1 in (470 mm x 545 mm x 105 mm)
BNA1000-2P8G5	300 kHz to 8.5 GHz	2		
BNA1000-4P8G5	300 kHz to 8.5 GHz	4		
BNA1000-2P20G0	1 MHz to 20 GHz	2	NMD 3.5 mm (m)	

Items Included with the Unit

- USB-B to USB-A Cable, 1 m
- 1 GB USB Flash Drive with software installer
- Power Cord, 1 m

BNA1000 VNA Optional Items

Options

- BNA1000-010, Time Domain
- BNA1000-1F5, Fixture circuit simulation function

Calibration Modules

- E285A, Electronic calibration module, 2 ports, 100 kHz to 8.5 GHz, 3.5 mm (f)
- E485A, Electronic calibration module, 4 ports, 100 kHz to 8.5 GHz, 3.5 mm (f)
- E285C, Electronic calibration module, 2 ports, 100 kHz to 8.5 GHz, N (f)
- E485C, Electronic calibration module, 4 ports, 100 kHz to 8.5 GHz, N (f)
- E226A, Electronic calibration module, 2 ports, 1 MHz to 26.5 GHz, NMD 3.5 mm (f)
- SK-CAL-NF-90, Calibration Kit, SOLT, DC to 9 GHz, N (f)
- SK-CAL-NM-90, Calibration Kit, SOLT, DC to 9 GHz, N (m)
- SK-CAL-SMAF-90, Calibration Kit, SOLT, DC to 9 GHz, SMA (f)
- SK-CAL-SMAM-90, Calibration Kit, SOLT, DC to 9 GHz, SMA (m)
- SK-CAL-35MM-265, Electronic calibration module, 2 ports, 1 MHz to 26.5 GHz, NMD 3.5 mm (f)

RF Cables

- T5-RFCAB-NMNM-90101 Test Cable, 1m, DC to 9 GHz, N (m) to N (m)
- T5-RFCAB-NMSMAM-90102 Test Cable, 1m, DC to 9 GHz, N (m) to SMA (m)
- T5-RFCAB-35NMD-260101 Test Cable, 0.6 m, DC to 26.5 GHz, NMD 3.5 mm (f) to NMD 3.5 mm (m)

BNA100 VNA Front Panel Description

Figure 1 BNA100 VNA Front Panel



Item	Name	Description
1	Test Port	The 50 Ohm test ports are used to connect the device under test (DUT) and calibration units.
2	Power Button	The power button is used to switch the power on and off.
3	Power LED	Green, when the unit is on the LED above the button will illuminate in green. Red, when the unit is off the LED above the button will illuminate in red.

BNA100 VNA Rear Panel Description

Figure 2 BNA100 VNA Rear Panel

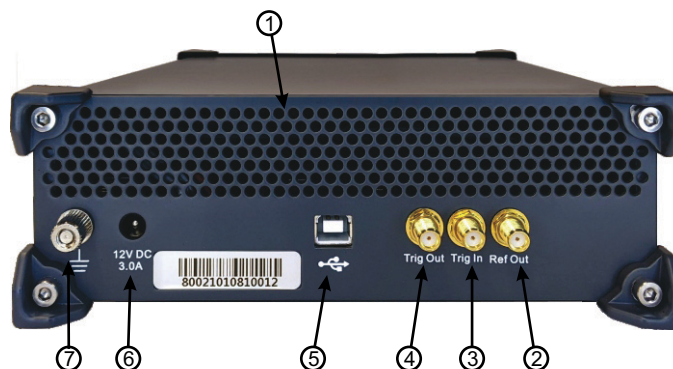

<i>Item</i>	<i>Name</i>	<i>Description</i>
1	Ventilation	Allows dissipation of heat within the enclosure.
2	10 MHz Reference Out	Ref Out - 10 MHz reference signal output interface. The VNA produces an internal clock signal, the 10 MHz output may be used as a reference clock for other instruments.
3	Trigger In	Trig In - SMA (female) input connector. Allows input TTL-level trigger signals for use by the Bird VNA.
4	Trigger Out	Trig Out - SMA (female) output connector. Provides TTL-level trigger signals.
5	USB Port	The USB type B connector is used to connect the BNA100 VNA to a computer to interface the software with the VNA.
6	DC Input Connector	12 VDC, 3.0 Amp power input connector. Power is provided by the included AC/DC power supply.
7	Ground Terminal	The ground terminal. The ground terminal should be connected when the BNA100 VNA is rack mounted.

BNA1000 VNA Front Panel Description

Figure 3 BNA1000 VNA Front Panel

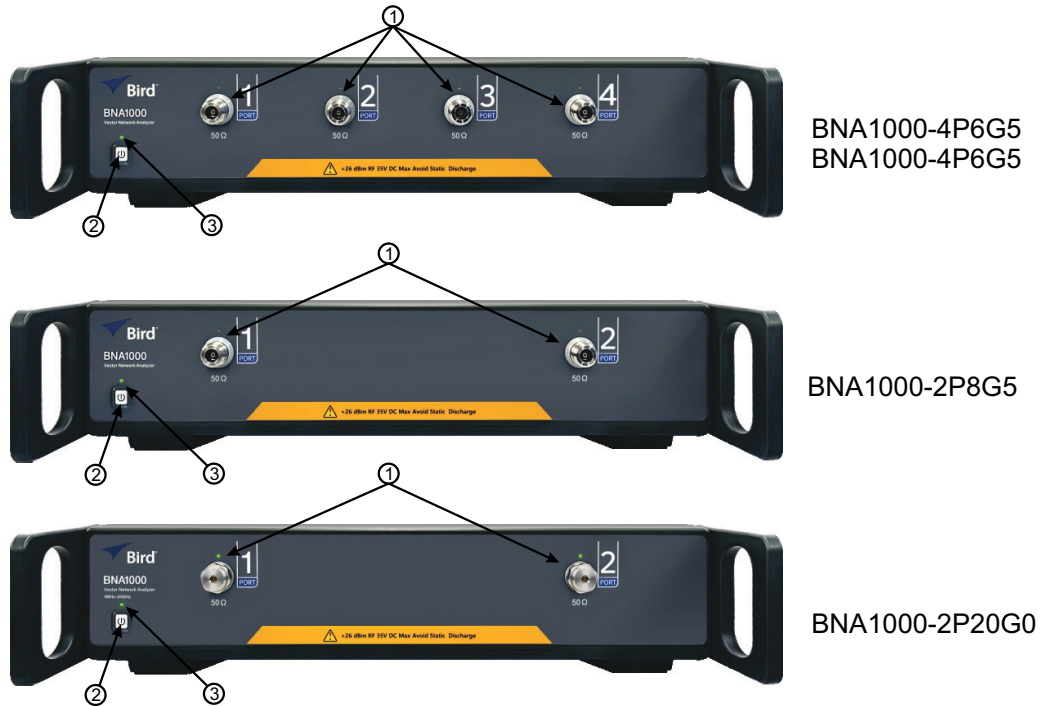

Item	Name	Description
1	Test Port	The 50 Ohm test ports are used to connect the device under test (DUT) and calibration units.
2	Power Button	The power button is used to switch the power on and off.
3	Power LED	Green, when the unit is on the LED above the button will illuminate in green. Red, when the unit is off the LED above the button will illuminate in red.

BNA1000 VNA Rear Panel Description

Figure 4 BNA1000 VNA Rear Panel

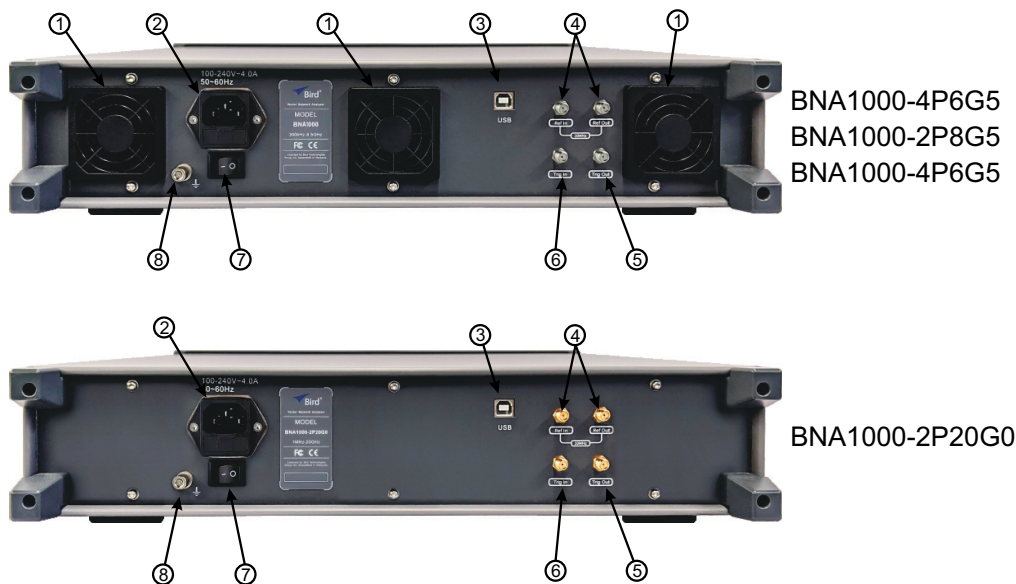

Item	Name	Description
1	Ventilation Fans	There are three ventilation fans used to provide cooling for the VNA's enclosure.
2	AC Input Connector	AC Power cord connector with fuse drawer. The VNA requires 100-240 VAC, 50-60 Hz, 4.0 A. The fuse is 5x20mm, 5A, 250V fast blow.
3	USB Port	The USB type B connector is used to connect the BNA1000 VNA to a computer to interface the software with the VNA.
4	10 MHz Reference In/Out	Ref In - 10 MHz reference signal input interface. When the BNA1000 VNA is configured for external reference, the unit will automatically lock onto the 10 MHz signal to improve measurement accuracy and frequency stability. Ref Out - 10 MHz reference signal output interface. The VNA produces an internal clock signal, the 10 MHz output may be used as a reference clock for other instruments.
5	Trigger Out	Trig Out - SMA (female) output connector. Provides TTL-level trigger signals.
6	Trigger In	Trig In - SMA (female) input connector. Allows input TTL-level trigger signals for use by the BNA1000 VNA.
7	Power Switch	The rear panel power switch is used to connect (I) or disconnect (O) the AC power from the AC Input connector.
8	Ground Terminal	The ground terminal accepts a banana plug. The ground terminal must be connected to an earth ground used for instrumentation.

Graphical User Interface Software

The Bird VNAs are supplied with a USB Drive containing the graphical interface VNA measurement and calibration software. The software is used to control the Bird VNA via USB from an external PC, the software simplifies the testing process with easy navigation and effective data analysis tools, enhancing your workflow efficiency. A comprehensive range of measurements and plot formats can be visualized, supporting various RF testing scenarios and offering a practical and streamlined experience for precise data analysis.

Table 3 Minimum PC system requirements

Operating system	Windows 7 and above
Processor	CPU frequency of 1.5 GHz or greater
RAM	1 GB RAM minimum
USB	2.0 or later

Software Installation

NOTE

Software installation requires administrator privileges.

1. Insert USB drive containing Bird VNA software installer into a USB port on the PC.
2. Navigate to the USB drive.
3. Double click the installation executable (exe).
4. Follow the on-screen prompts to complete installation.

Bird VNA Operating Power Connection

WARNING

Outlets must match the supplied AC plug, never modify the plug in any way. Do not use any adapter plugs with grounded components. If the plug will not fit the outlet, have a proper outlet installed and grounded by a qualified electrician in accordance with all codes and ordinances. Standardized, grounded plugs and outlets reduce risk of electric shock, serious injury, or death.

BNA100 VNA

1. Insert the DC plug on the AC/DC Adapter into the 12 VDC, 3.0 Amp power port on the rear panel of the BNA100 VNA.
2. Plug the Adapter into an AC power source, verify the power supply meets the specified requirements. The AC/DC Adapter requires 100-240 VAC, 50-60 Hz, 1.5 A.
3. Ensure the instrument is correctly grounded. The ground terminal on the rear panel should be connected if the unit is rack installed.

BNA1000 VNA

1. Connect the BNA1000 VNA to an AC power source, verify the power supply meets the specified requirements. The VNA requires 100-240 VAC, 50-60 Hz, 4.0 A.
2. Ensure the instrument is correctly grounded. The ground terminal on the rear panel should be connected if the unit is rack installed.

Start Up

1. Disconnect any devices connected to the VNA's test ports and any associated connections.
2. Connect the Bird VNA to the PC or laptop using the supplied USB cable.
3. (BNA1000 VNA Only) Set the rear panel power switch to on (I).
4. Press the power button on the front panel of the Bird VNA.
5. Launch the software on your PC or laptop.
6. Wait for the software to connect with the Bird VNA.
7. The main interface will display the instrument status as "Ready" once connected. See [Figure 5](#).

Figure 5 Status Bar



8. If the instrument has not been started for an extended period, it is essential to allow it to warm up for 40 minutes before commencing measurements.
9. Following warm-up period, perform the actions outlined in [Measurement Steps](#) below to ensure highest accuracy.

Measurement Steps

CAUTION

**Do not exceed the maximum input power +23dBm RF, 35 VDC.
Take precaution to avoid static discharge into the Bird VNA.**

The fundamental steps for taking measurements are outlined below.

1. Set the measurement conditions (Initialization parameter > Select Measurement parameters > data format > scan type and range > power level > IF Bandwidth). See ["Measurement Conditions" on page 14](#).
2. Perform calibration (Select Calibration kit > Calibrate). See ["Calibration Types And Procedures" on page 36](#).
3. Connect the device under test (DUT) (Connect DUT > adjust scale).
4. Measure the output (save measurements results file).
5. Analyze measurement results (Use markers for analysis). See ["Measurement Analysis" on page 49](#)

User Interface Description

The user interface is installed and run on a computer. The Bird VNA requires a USB connection with the computer running the software.

Configuration/Control Menus

There are two menus that are used to control the behavior and display. The function menu contains all of the controls available for controlling the Bird VNA. The menu bar can be used for shortcuts to specific options on the function menu.

Figure 6 *User Interface Description*

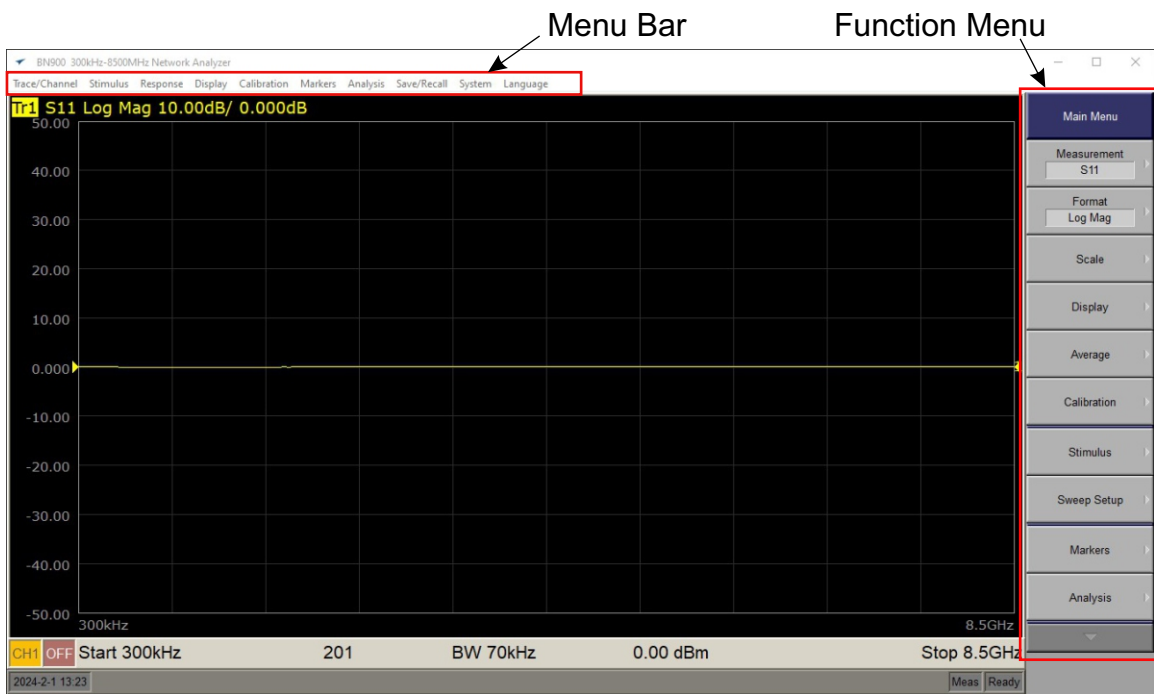

<i>Name</i>	<i>Description</i>
Menu Bar	The menu bar provides options for controlling the Bird VNA. When an option is clicked, the function menu options will change to provide additional options. Some options on the menu bar will open a data entry dialog, see "Data Entry Bar" on page 13.
Function Menu	The function menu display's options related the menu items in the menu bar. The function menu is the primary interface for changing the Bird VNAs behavior. See "Function Menu" on page 10.

Function Menu

The function menu consists of a menu title, in blue at the top of the menu, and the options available within that menu. Each option can be clicked or tapped. Options vary, some act directly on the display, some open a sub-menu, other options will open a data entry dialog (see "[Data Entry Bar](#)" on page 13), and other options provide interaction with the PC's operating system for saving and printing.

Figure 7 Function Menu



Name	Description
Function Buttons	Each option on the function menu will either perform a function or allow the user to configure the selected option.
Active selection	<ul style="list-style-type: none"> • Dot symbol indicates the active selection on the function menu.
Scroll button	The scroll button is displayed when additional options are available on the function menu, clicking the scroll button will display the hidden options.
Sub menu available	<ul style="list-style-type: none"> ▶ The arrow symbol, shown on the right side of the function button, indicates that clicking the function button will reveal a subset of functions within the menu.

Display Area

The display area is used to display the trace/channel data. The display area can be configured to display multiple traces and multiple channels. The system has the ability to display up to 16 traces per channel and up to 16 channels. Trace data can be displayed in various formats to aid in signal analysis, see [Figure 8](#).

Figure 8 VNA Display

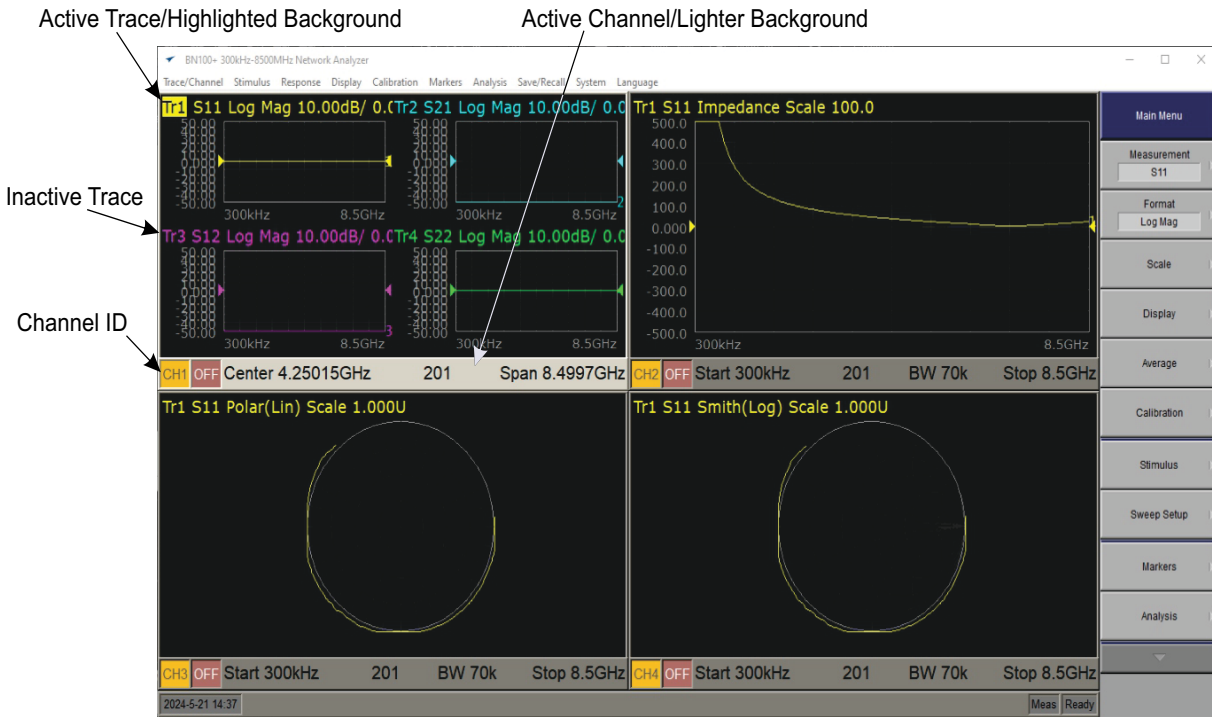

Active Trace — The active trace has a highlighted background (see [Figure 8](#)), clicking on a trace will make a trace active. Alternatively, the Active Trace/Channel function menu (see [Figure 9](#)) can be used to make the next or previous trace active.

Active Channel — An active channel has a lighter background (see [Figure 8](#)), where the channel parameters are shown, clicking on a channel (or trace in a channel) will make the channel active. Alternatively, the Active Trace/Channel function menu (see [Figure 9](#)) can be used to make the next or previous channel active.

Traces and Channels

Each channel may have distinct measurement parameters. In [Figure 9](#), both channel 1 and channel 2 are measuring the same signal. Channel 2 however is displaying only a portion of the span displayed in Channel 1.

Each channel and trace can display different aspects of the same measurement, or completely different measurements. The measurement parameters are displayed at the bottom of the channels display.

Figure 9 Channel Window

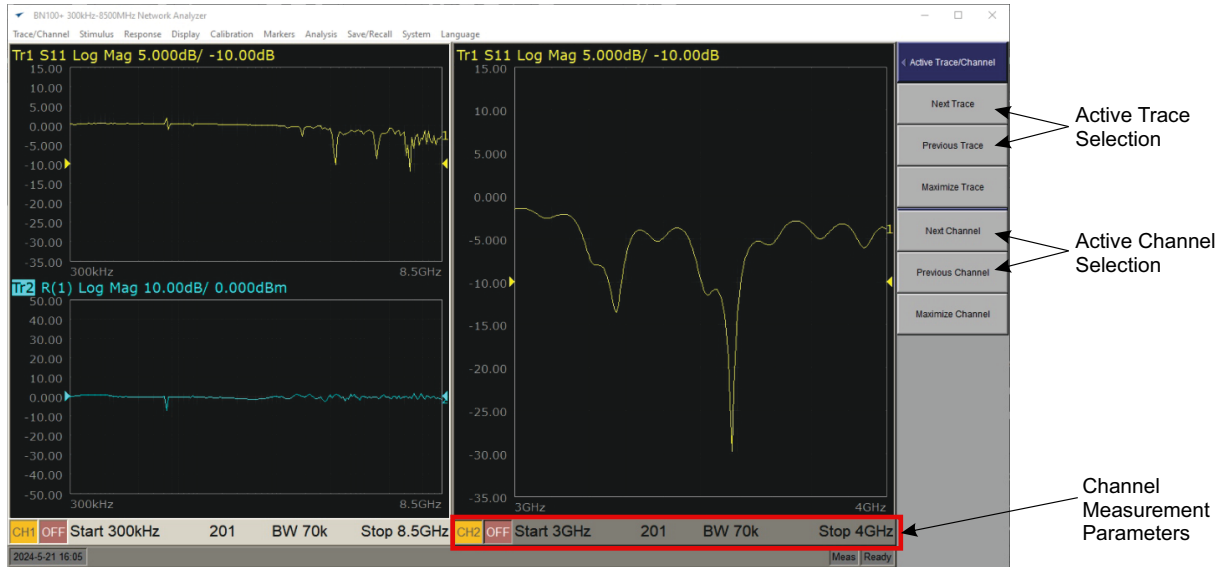

Channel 1
Active Channel

Channel 2

Data Entry Bar

When options on the function menu are selected that require a numeric or text input the Data Entry Bar will open at the top of the display, see [Figure 10](#).

Figure 10 Data Entry Bar



Name	Description
Parameter Name	Indicates the designated label or identifier of the parameter for which you intend to input a value.
Data Entry Box	During the initial instance, the data entry field will exhibit the present configuration for the selected parameter. The input value can be entered by manual typing or by utilizing the mouse to interact with the 'Coarse Adjustment' and 'Fine Adjustment' buttons for adjustment.
Fine Adjustment Buttons	Utilize the on-screen mouse interface to slightly increment or decrement the value within the data entry box through gradual adjustments. To increase the value in the Data Entry Box, click the upward pointing button; to decrease the value, click the downward pointing button.
Coarse Adjustment Buttons	Utilize the on-screen mouse pointer to significantly increment or decrement the value within the Data Entry Box. To increase the value, click the upward pointing button; to decrease the value, click the downward pointing button.
OK Button	Click this button to accept the entered value.
Cancel Button	Close the data entry box by clicking this button.

Instrument Status Bar

The instrument status bar displays the present operational condition of the entire instrument at bottom right.

Figure 11 Status Bar



Name	Description
Ready	Indicates that the instrument is operating normally
Connecting	Indicates that the instrument is abnormal

Restore Factory Default Settings

The preset option on the System Menu restores the instrument to its factory default settings.

To reset the Bird VNA to factory default settings:

1. Click on the **System** menu
2. Click the **Preset** option to display the function menu.
3. Click the **OK** function button to reset the Bird VNA to the factory default settings.

Figure 12 Preset Function Menu

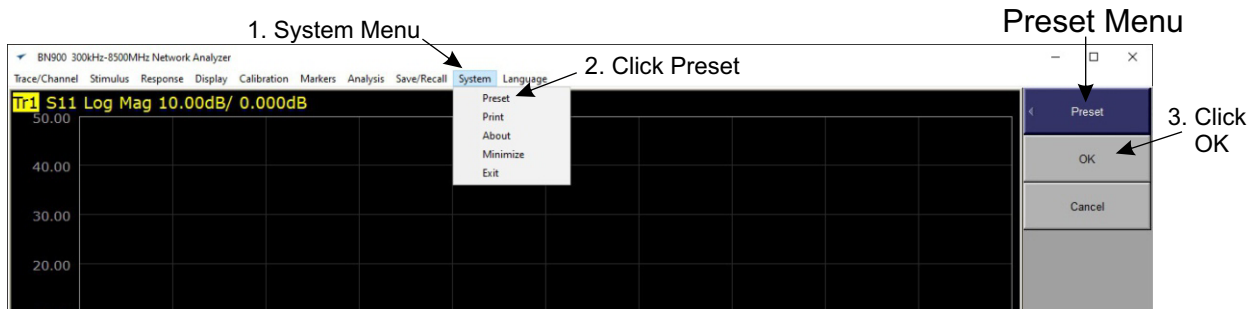

Calibration/System Z0

Z0 represents the system impedance of a measurement path, typically matching the impedance of the calibration standards leveraged during the official calibration process. It is crucial to define the Z0 value prior to calibration, as it plays a key role in the calculations of calibration coefficients.

To adjust the system Z0 value:

1. Click on the **Calibration** menu, see [Figure 13](#).
2. Click **System Z0** to display the data entry dialog.
3. Type the impedance value into the data entry dialog.
4. Click the **OK** button.

Figure 13 Setting System Impedance (Z0)

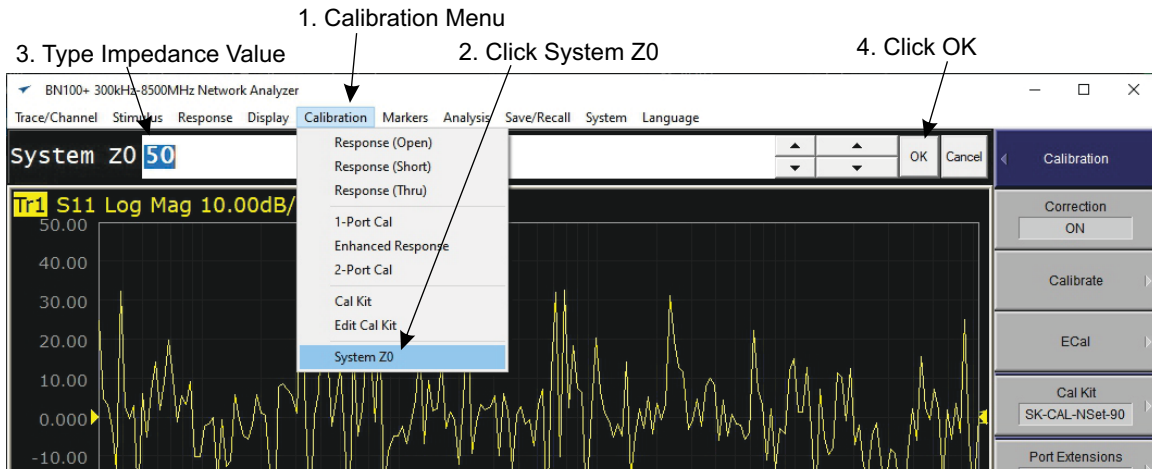

Channel and Trace Setup

Number of Channels and Layout

Channel Allocation — The allocate channels function menu gives the user the option of selecting how many channels are displayed and how the channels will be organized in the display area.

Active Channel — Before any settings can be changed for a particular channel the channel must be made the active channel. Clicking in a channel area or clicking a trace within a channel will make the channel active.

Modify the channel allocation settings:

1. Click on the **Display** menu.
2. Click on the **Allocate Channels** option.
3. Click to select the preferred window layout as depicted on the function bar.

Figure 14 Channel Layout

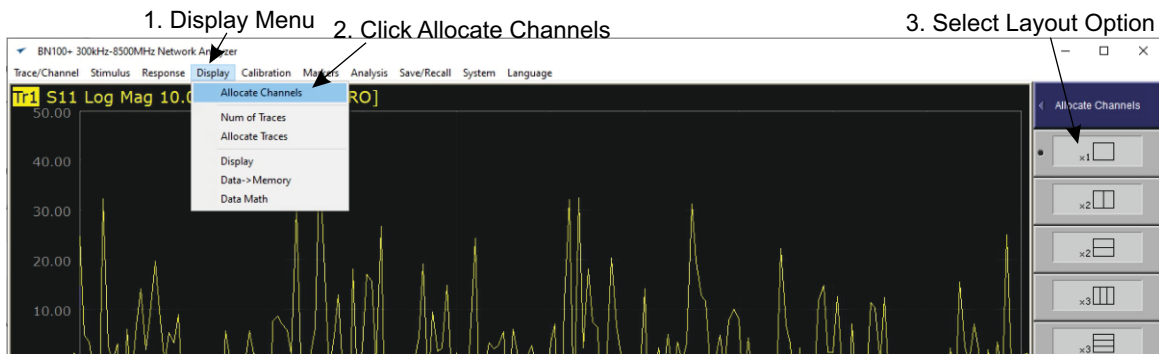

Set the active channel:

1. Click on **Trace/Channel**
2. Click **Active Trace/Channel**
3. Click Next Channel or Previous Channel to change the active channel.

Alternative methods:

- Single-click on the desired channel on the screen to activate it.
- Double-click anywhere in the desired channel view to toggle between maximizing and minimizing the active channel.

Figure 15 Set Active Channel

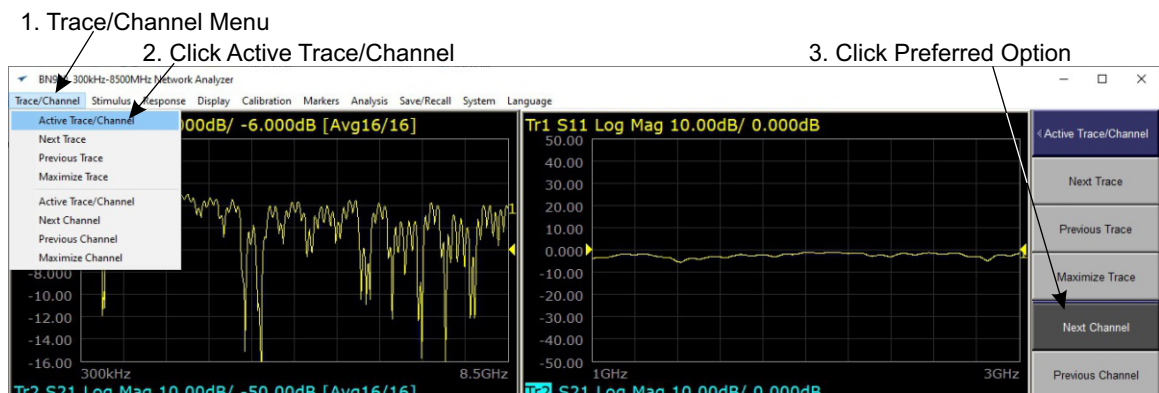

Number of Traces and Layout

Number of Traces — Each channel can display as many as 16 measurement traces. Each trace can be set to display unique measurement information.

Trace Allocation — The allocate traces function menu gives the user the option of selecting how the traces will be organized within the channel.

To modify the number of traces:

1. Select the channel for which you wish to configure the number of traces.
2. Click the **Display** menu.
3. Click the **Num of Traces** option.
4. Click the option on the function panel for the number of traces to display in the channel.

Figure 16 Set Number of Traces to Display

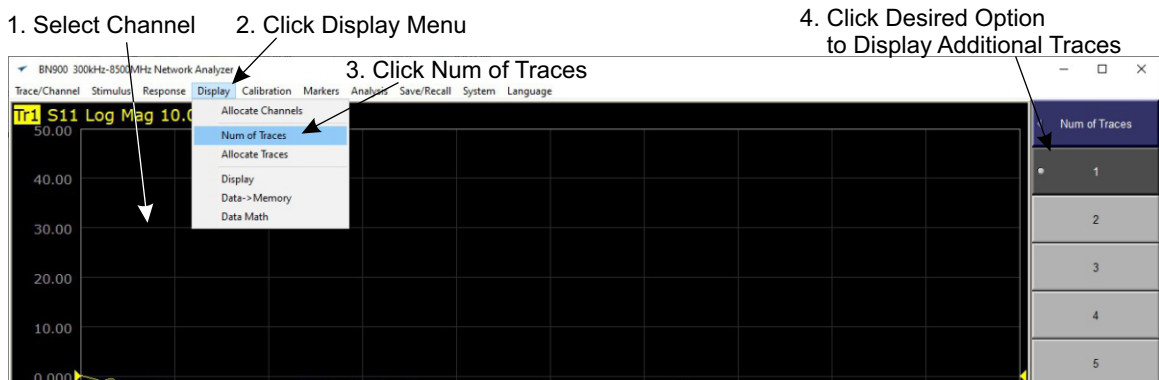

Trace Display Window Layout Settings

When a channel is configured to display multiple traces, the layout within the channel view can be modified to provide a custom trace layout.

To modify the trace layout within the channel view:

1. Select the desired channel for configuring the trace.
2. Click the **Display** menu
3. Click **Allocate Traces**
4. Click desired window layout on the function panel.

Figure 17 Allocate Traces

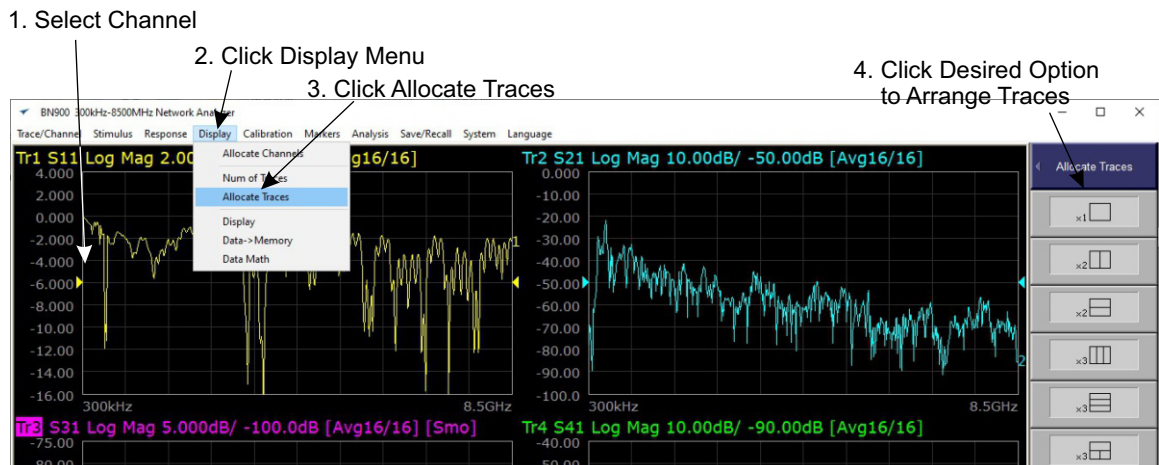

Active Trace

When multiple traces are in a channel, before any settings can be changed for a particular trace the trace needs to be made the active trace.

Set the active trace:

1. If required, make the channel containing the trace active (see "[Set the active channel:](#)" on page 15).
2. Click on **Trace/Channel** menu.
3. Click on **Next Trace** or **Previous Trace**.

Alternative methods:

- Single-click on the desired trace on the screen to activate it.
- Double-click anywhere in the desired trace view to toggle between maximizing and minimizing the active trace.

Figure 18 Set Active Trace

1. Click Channel to make active
2. Trace/Channel Menu
3. Click Next Trace / Previous Trace



Stimulus

Sweep Type

The available sweep types include:

Sweep Type	Description
Linear	Linear frequency sweeping
Log	Logarithmic frequency sweep
Segment	Segmented frequency sweep
Power	Power sweep

To change the sweep type:

1. Set channel to change to active
Click on 'Trace/Channel' and then select 'Next Channel' or 'Previous Channel' from the menu bar, or simply single-click on the desired channel.
2. Click the **Stimulus** menu.
3. Click Sweep Type from the drop down menu and choose the desired scan type to be executed.

Figure 19 Sweep Type

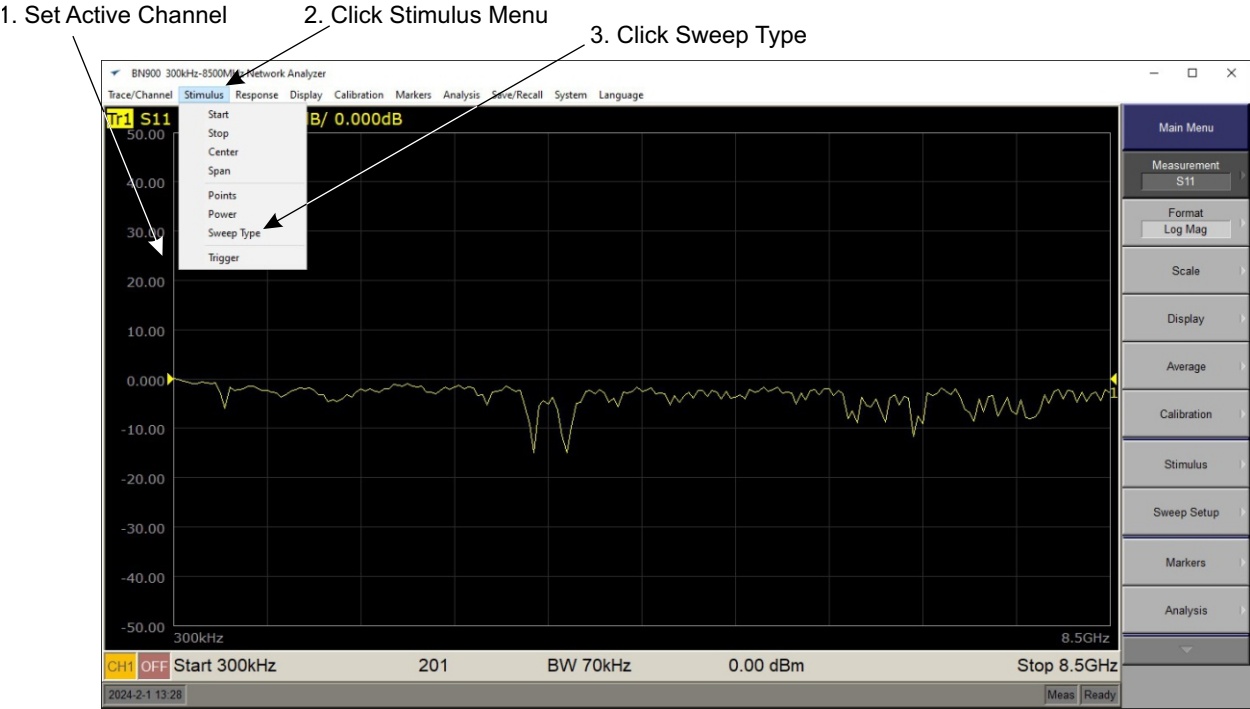

Sweep Range

The sweep range can be defined in two ways.

- The range can be set by entering frequency ranges, see [Define Sweep Range Using Frequency](#).
- The range can be set by position of markers, see [Define Sweep Range Using Markers](#).

Define Sweep Range Using Frequency

NOTE

*When typing a frequency in the data entry bar, enter the numeric value followed by a K, M, or G.
If a value is entered without a suffix, the system will default to 300 kHz.*

Start/Stop:

1. Click **Stimulus** menu.
2. Click **Start**, and input the starting frequency value.
3. Click **Stimulus** menu, then click **Stop**, and input the stop frequency value.

Center/Span:

1. Click **Stimulus** menu.
2. Click **Center**, and input the center frequency value.
3. Click **Stimulus** menu, then click **Span**, and input the span frequency value.

Figure 20 Sweep Range Defined by Frequency

1. Click Stimulus Menu 2. Click Start OR 2. Click Center

3. Click Stop 3. Click Span

2. Click Start

3. Click Stop

OR

2. Click Center

3. Click Span

Start / Stop Frequency
Sweep Range

Center Frequency / Span
Sweep Range

Define Sweep Range Using Markers

The marker function options are as follows:

Function Button	Description
Marker > Start	Set the Start value to the Marker value selected on the currently active trace.
Marker > Stop	Set the Stop value to the Marker value selected on the currently active trace.
Marker > Center	Set the Center value to the Marker value selected on the currently active trace.

To set the sweep range by marker:

1. Click the **Markers** menu.
2. Click the **Marker Functions** option.

Start/Stop:

- a. Select Marker for Start Frequency in the active trace.
- b. Click **Marker->Start** on the Marker Functions panel.
- c. Select Marker for Stop Frequency in the active trace.
- d. Click **Marker->Stop** on the Marker Functions panel.

Center/Span:

- a. Select Marker for Center Frequency in the active trace.
- b. Click **Marker->Center** on the Marker Functions panel.

NOTE

In cases where the Marker value is relative to the reference marker, its absolute value will be established within the scan range.

Figure 21 Sweep Range Defined by Markers

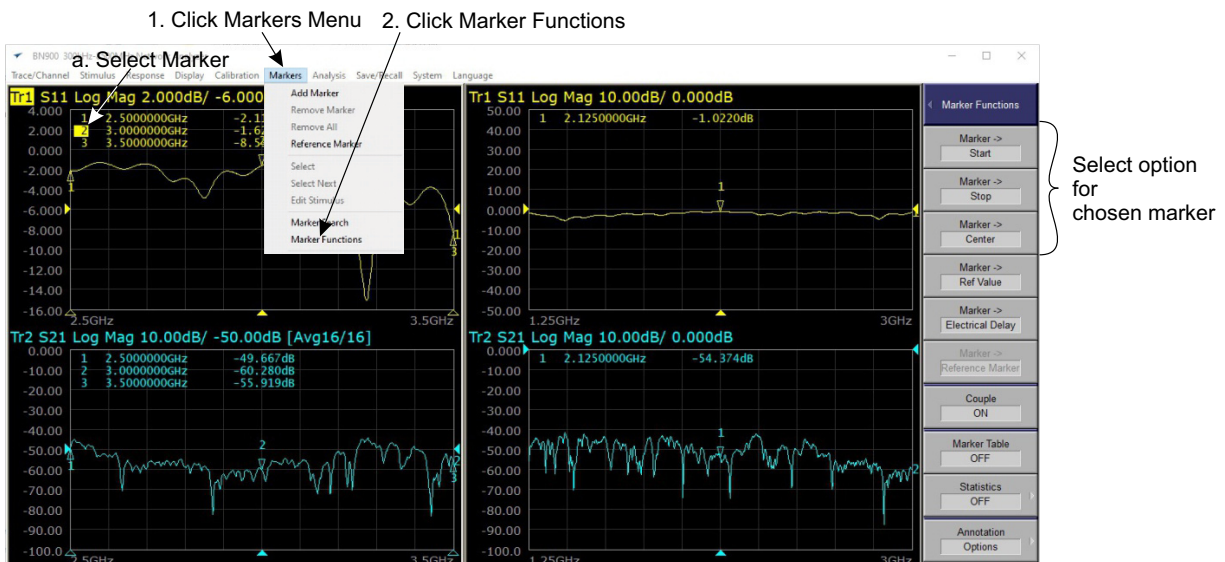

Power

For the frequency sweep mode, the source output power can be entered to fine-tune the VNA.

To adjust the power setting:

1. Click the **Stimulus** menu.
2. Click the **Power** option.
3. Click Power Function Panel button.
4. Type the RF source output power value into the Data Entry Dialog Bar.

Additional power adjustments for the source output power

Slope Factor - set the slope factor using the slope data option.

Power Compensation - enable or disable power compensation using Slope State option.

Adjust Power Slope Data correction factor setting:

5. Click 'Slope Data' and input the desired value.

Enable/Disable Power compensation Slope State:

6. Click 'Slope State' to toggle between the ON and OFF state. When set to ON, compensation power is activated; when set to OFF, compensation power is deactivated.

Figure 22 Power Settings

1. Click Stimulus Menu

2. Click Power

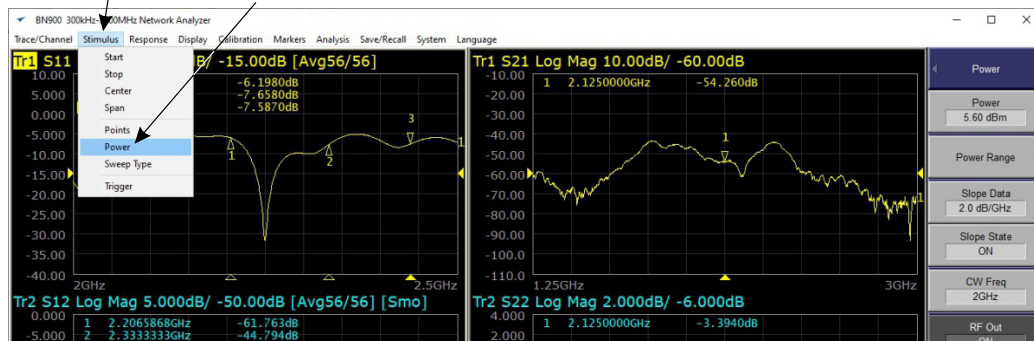

3. Click Power

5. Click Slope Data

6. Click Slope State

CW Freq

The fixed frequency used for linear power sweeps is defined through the CW frequency setting.

To modify the CW frequency:

1. Choose the channel you wish to configure.
2. Click on the **Stimulus** menu.
3. Click **Power** option.
4. Click **CW Freq** on the functions panel.
5. Type the desired continuous wave (CW) frequency into the Data Entry Dialog Bar.

Figure 23 CW Frequency Setting

1. Set Active Channel

2. Click Stimulus Menu

3. Click Power



4. Click
CW Freq

RF Out

This option allows you to enable or disable the output of the excitation signal. When the excitation signal is disabled, regular measurements cannot be carried out. It's not mandatory to deactivate the excitation signal output. This function is primarily used to restart the excitation signal if it has been stopped.

To modify the RF Out state:

1. Choose the channel you wish to configure.
2. Click on the **Stimulus** menu.
3. Click **Power** option.
4. Click **RF Out** on the functions panel to toggle between ON and OFF with each click.
When set to ON, the signal output is activated. When set to OFF, the signal output is deactivated.

Figure 24 RF Out Setting

1. Set Active Channel

2. Click Stimulus Menu

3. Click Power

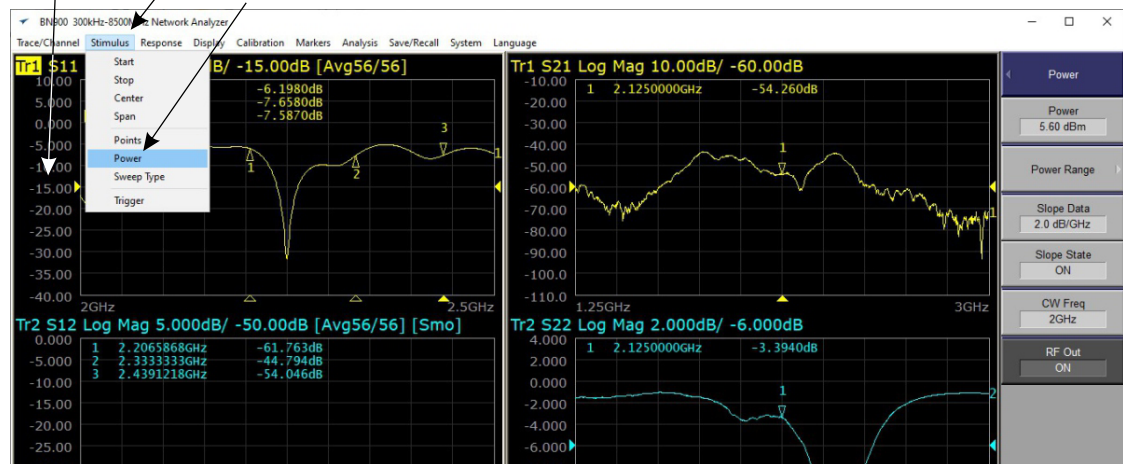

4. Click RF Out

Points

The number of points refers to the quantity of data collected in a single iteration. Its purpose is to achieve a finer trace resolution for the stimulus value. The selection of scanning points is usually determined by the following considerations:

- To achieve a higher trace resolution for the stimulus value, opt for a larger point value.
- For increased throughput, stay within a smaller value while adhering to the allowable trace resolution range.
- For enhanced measurement accuracy after calibration, use the same points as the actual measurement for calibration.

To modify the number of Points:

1. Choose the channel you wish to configure.
2. Click on the **Stimulus** menu.
3. Click **Points** option.
4. Click **Points** on the functions panel.
5. Type the desired number of points into the Data Entry Dialog Bar. Allowable range is 2 to 20001.

Figure 25 Points Setting

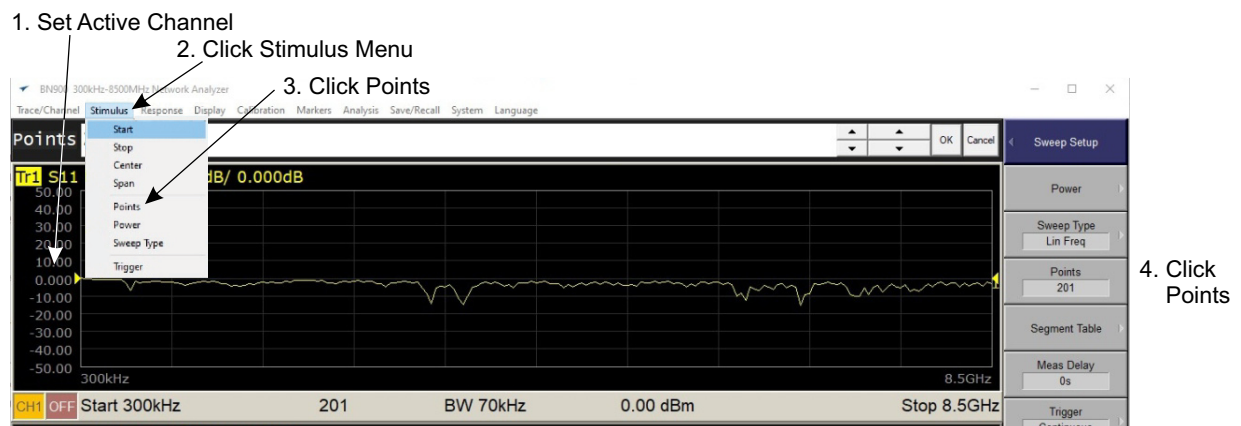

Measurement Delay

Measurement delay is defined as the time between when the source output stabilizes and the measurement starts. The operator has the option of defining the duration of this delay.

Figure 26 Measurement Delay Diagram

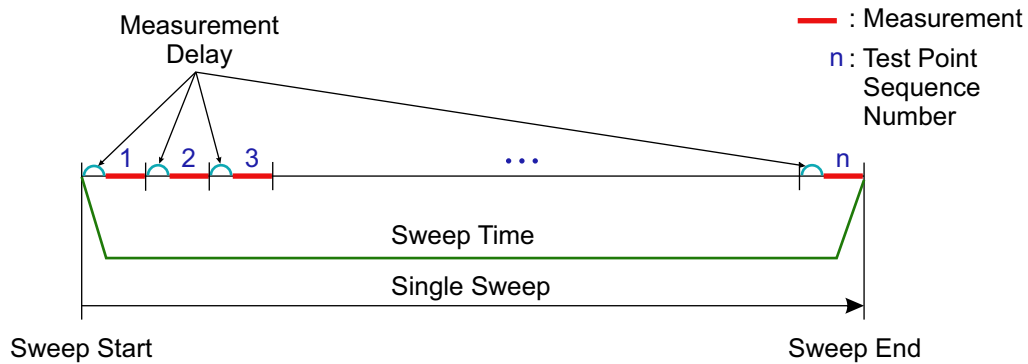

To modify the Measurement Delay:

1. Choose the channel you wish to configure.
2. Click on the **Stimulus** menu.
3. Click **Points** option.
4. Click **Meas Delay** on the functions panel.
5. Type the desired measurement delay into the Data Entry Dialog Bar.

Figure 27 Measurement Delay Setting

1. Set Active Channel

2. Click Stimulus Menu
 3. Click Points
 4. Click Meas Delay

Measurement

Measurement parameters are applied to the individual traces defined for a channel. The options for setting the different measurement parameters are provided in the sections below.

S-Parameter Measurement

The S-parameter (Scattering Parameter) is used to assess the characteristics of both the reflected and transmitted signals of the Device Under Test (DUT). This parameter is established by the ratio of two complex numbers, encompassing details about the signal's amplitude and phase.

For instance, the S21 parameter represents the ratio of the output signal from Port 2 of the DUT to the input signal at Port 1 of the DUT. Both the output and input signals are represented in the form of complex numbers.

To modify the S-parameter setting:

1. Choose the channel to configure.
2. Click the **Response** menu.
3. Click the **Measurement** option.
4. Click the appropriate function button corresponding to the desired S parameter.

NOTE

*The S parameter options provided depends on the VNA model being used.
A 2-port model will include S11, S21, S12, and S22.
A 4-port model will include many more permutations based on port availability.*

Figure 28 S Parameter Selection

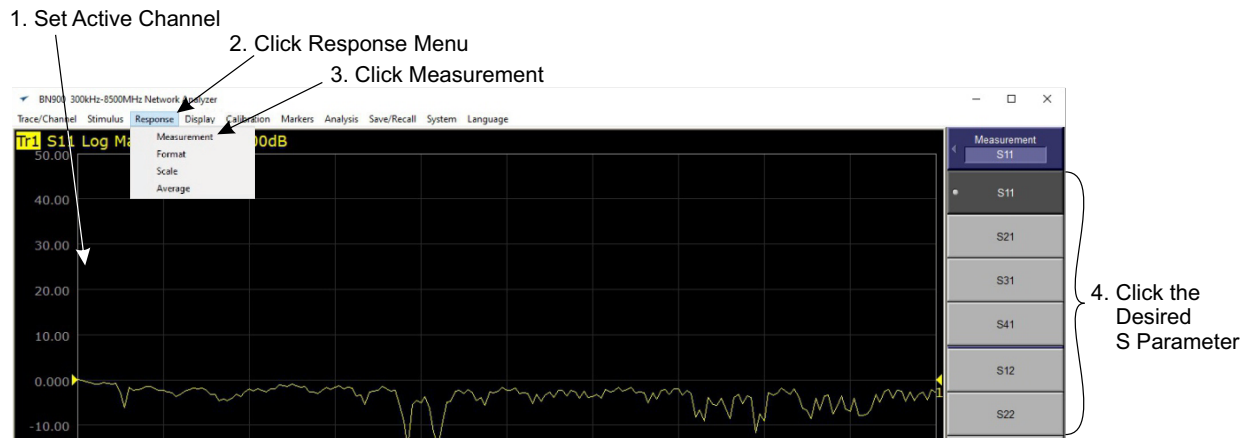

Absolute Power Measurement

Absolute power measurement is used to determine the absolute power of both the reference signal and the received signal at the test port. In a 2-port dual-channel vector network, there are four independent receivers: two test signal receivers labeled as Receiver A and Receiver B, as well as two reference signal receivers designated as Receiver R1 and Receiver R2, as illustrated in the diagram below.

Figure 29 Vector Structure Diagram

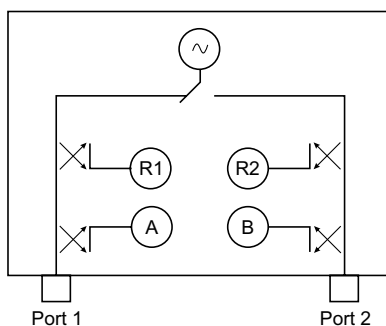

Symbols	Definition
A(1)	Test signal receiver A (source Port 1)
A(2)	Test signal receiver A (source Port 2)
B(1)	Test signal receiver B (source Port 1)
B(2)	Test signal receiver B (source Port 2)
R1(1)	Reference signal receiver R1 (source Port 1)
R2(2)	Reference signal receiver R2 (source Port 2)

The following list provides additional detail on the absolute power modes:

- Receiver A1 (Source Port 1): A 1-port test receiver that measures the signal power from Source Port 1.
- Receiver A2 (Source Port 2): A 1-port test receiver that measures the signal power from Source Port 2.
- Receiver B1 (Source Port 1): A 2-port test receiver that measures the signal power from Source Port 1.
- Receiver B2 (Source Port 2): A 2-port test receiver that measures the signal power from Source Port 2.
- Receiver R1 (Source Port 1): A 1-port reference receiver used to measure the reference signal power from Source Port 1.
- Receiver R2 (Source Port 2): A 2-port reference receiver used to measure the reference signal power from Source Port 2.

To modify the absolute power measurement setting:

1. Choose the channel to configure.
2. Click the **Response** menu.
3. Click the **Measurement** option.
4. Click the **Absolute** button on the function menu to access the absolute power measurement function menu.
5. Click the desired function button from the list for the corresponding measurement, as depicted in [Figure 30](#).

Figure 30 Absolute Measurement Selection

- 1. Set Active Channel
- 2. Click Response Menu
- 3. Click Measurement



- 4. Click the Desired Absolute Parameter

Format

The Bird VNA offers three distinct data display formats: Rectangular, Polar Coordinate, and Smith Chart display formats. See [Figure 31](#).

Rectangular

Includes Log Mag, SWR, Phase, Expand Phase, Group Delay, Lin Mag, Real and Imaginary. The specific meaning is as follows:

Type Symbol	Introduction	Unit
Log Mag	Amplitude: Return loss measurement, Insertion loss or Gain measurement	dB
SWR	Voltage Standing Wave Ratio	
Phase	Phase (Range is -180° to $+180^\circ$) Measure the deviation from the linear phase.	Degree ($^\circ$)
Expand Phase	Display a phase of $+180^\circ$ or more and -180° or less	Degree ($^\circ$)
Group Delay	Signal transmission delay in the DUT	Second (s)
Lin Mag	Linear Magnitude	
Real	The real part of the measured complex parameter	
Imag	The imaginary part of the measured complex number	
Impedance	Defines the impedance values.	ohm

Polar Coordinate

Magnitude is depicted by the displacement from the origin, and the traces are displayed with an offset from the positive X-axis in the counterclockwise direction. The tag response values can be displayed for any one of the following three data sets:

- Log/Phase
- Lin/Phase
- Real/Imag.

Smith Chart

The Smith chart format is utilized for illustrating impedance based on the measurement data of Device Under Test (DUT) reflections. The tag response value can be displayed for any one of the following three data sets:

- Log/Phase
- Lin/Phase
- Real/Imag.
- $R+jX$
- $G+jB$

Figure 31 Display Formats

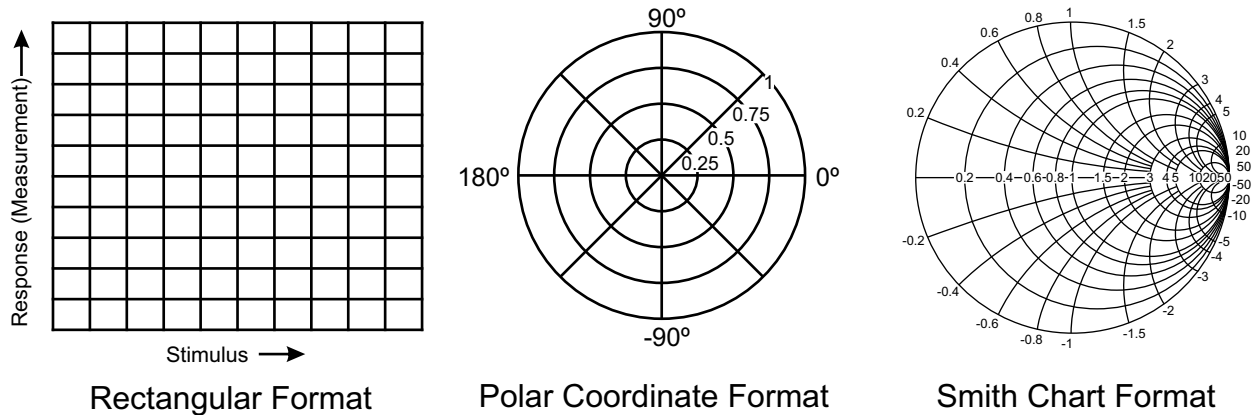
**To modify the display format settings:**

1. Choose the channel to configure.
2. Click the **Response** menu.
3. Click the **Format** option.
4. Click on the desired format on the function menu.

Scale**Auto Scale**

The auto scale function is used to automatically adjust each scale, including scale/index and reference lines, to render the trace on the screen at an optimal size for enhanced visibility.

To perform auto scale on a single trace:

1. Choose the desired trace you wish to scale.
2. Click the **Response** menu.
3. Click the **Scale** option.
4. Click the **Auto Scale** button on the function panel to automatically adjust both the index and scale.

To perform auto scale on all traces within the active channel:

1. Click the **Response** menu.
2. Click the **Scale** option.
3. Click the **Auto Scale All** button on the function panel to automatically adjust both the index and scale for all traces.

Adjust the Cartesian Scale Manually

When using Cartesian display formats, you have the option to manually adjust the scale using four parameters.

To adjust scale manually:

1. Choose the desired trace you wish to scale.
2. Click the **Response** menu.
3. Click the **Scale** option.
4. Choose the appropriate button on the function panel to adjust the specific characteristics. See [Figure 32](#).

Figure 32 Manual Scale Adjustments

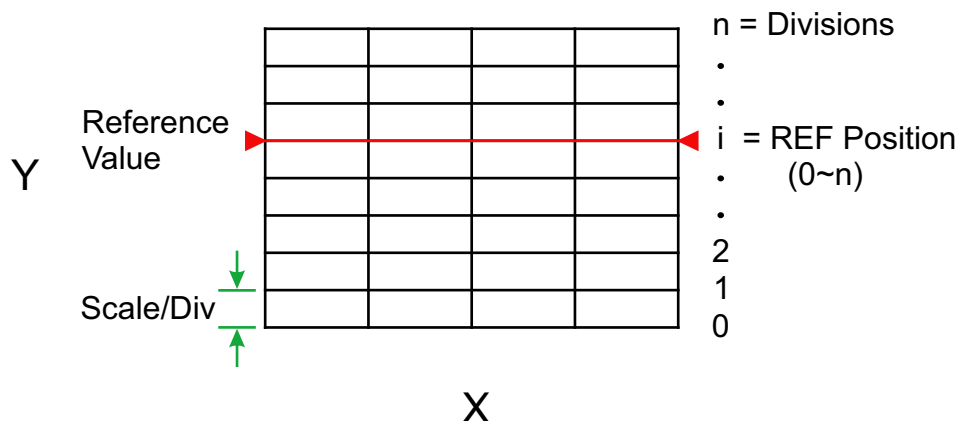

Function Keys	Function
Divisions	Defines the degree of division on the Y axis
Scale/Div	Defines the number of increments for each index on the Y axis
Ref Position	Defines the position of the reference line
Ref Value	Defines the value corresponding to the reference line

Adjust the Polar Plot and Smith Chart Scale

Utilize the outermost scale/division (displacement) to manually adjust the Smith chart format or the polar coordinate format, as depicted below:

To adjust the polar or Smith chart scale:

1. Choose the channel to configure.
2. Select the desired format, see ["To modify the display format settings:" on page 30](#)
3. Click the **Response** menu.
4. Click the **Scale** option.
5. Use the Data Entry Bar to adjust the specific characteristic values.

Figure 33 Polar Plot and Smith Chart scale adjustment

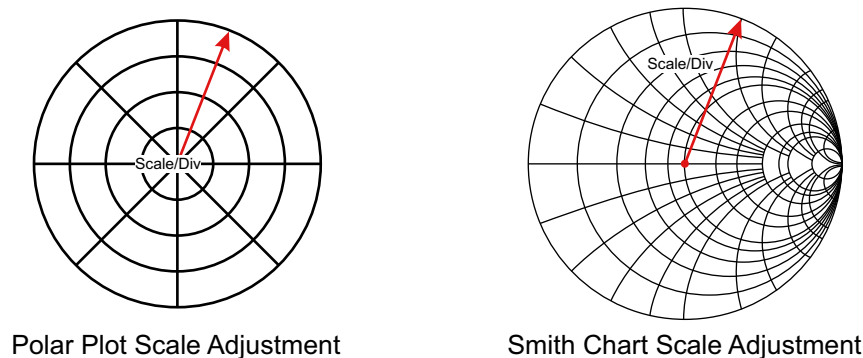

Other Scale Parameter Settings

Electrical delay

Adjust this setting to enhance the resolution of phase measurement, enabling the measurement of linear phase offsets. This function enables you to assign an electrical delay for each trace.

To adjust the electrical delay:

1. Choose the channel or trace to configure.
2. Click the **Response** menu.
3. Click the **Scale** option.
4. Click **Electrical Delay** button on the function panel to adjust the specific characteristics and input the desired value.

Phase offset

Employ this function to simulate a phase shift resulting from events like adding a cable.

To adjust the phase offset:

1. Choose the channel or trace to configure.
2. Click the **Response** menu.
3. Click the **Scale** option.
4. Click **Phase Offset** button on the function panel to adjust the specific characteristics and input the desired value.

Figure 34 Scale Adjustments Function Panel

1. Set Active Channel
2. Click Response Menu
3. Click Scale

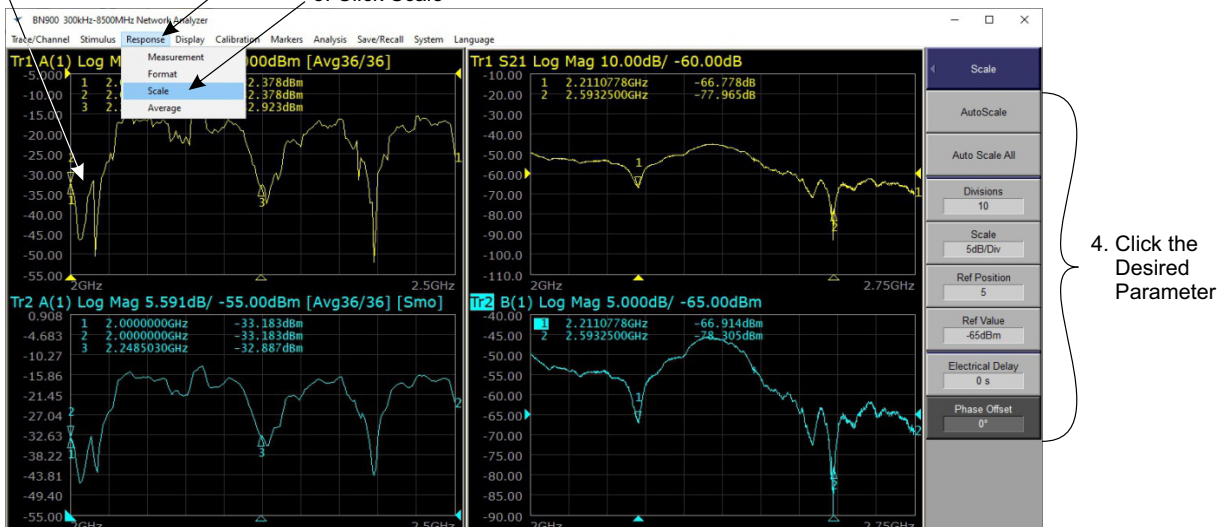

Display

Trace Data Presentation Operations

This function enables the selection of trace measurement data and memory data, followed by subsequent operations on the displayed data. Each trace displaying measurement data includes an additional trace, referred to as a storage trace, designed for temporary storage of measurement data. Storage traces can be used to compare traces on the screen or perform intricate data calculations between measurement data and storage traces.

To define the trace data to be shown:

1. Choose the desired channel or trace to be modified.
2. Click **Display** Menu.
3. Click **Display** option.
4. Select the data type for the trace display from one of the following options:

Function Button	Description
Data	Only the measurement data of the trace is displayed, or the result of the measurement data and the memory data operation is displayed.
Memory	Only the memory trace data is displayed.
Data & Memory	Display the measurement data of the trace, or display the result of the measurement data and the memory data, and the memory trace data.
OFF	Turn off the measurement data, or the operation data, as well as the display of the memory trace data.

To capture into memory (the storage trace):

1. Navigate up one level by clicking the purple 'Display' button at the top of the options column on the right-hand side of the screen.
2. Save the active trace to memory by clicking on the Display->'Data->Memory' option on the right-hand side of the screen.

To perform trace data math operations:

1. Click the Display->'Data Math' option from the menu bar to expose function options on the right-hand side of the screen.
2. Choose the desired measurement trace data and memory data for calculation. Options are as follows:

Function Button	Introduction
Data/Mem	The measurement data for the current trace is divided by the memory data which is used to evaluate the ratio of the current measurement data to the memory data such as the evaluation magnification, the attenuation factor and so on.
Data*Mem	The measured data of the current trace is multiplied by the memory data.
Data-Mem	The measurement data for the current trace minus the memory data, which is often used to evaluate the vector error.
Data+Mem	The current trace of the measured data plus the memory data.
OFF	Turn off the trace data operation function.

Title

This function permits the assignment of a name to a channel, with the name then being displayed on the screen when enabled. This feature proves valuable for saving, printing, archiving measurement results, and enhancing result organization.

To add or modify the title for the channel:

1. Choose the desired channel or trace to scale.
2. Click on the purple button at the top of the options presented at the right-hand side of the screen until reaching 'Main Menu'.
3. Click the **Display** option on the function panel.
4. Click the **Edit Title Label** button to expose the text entry tool at the top of the screen.
5. Type the desired channel window title.

Figure 35 Edit Title Label

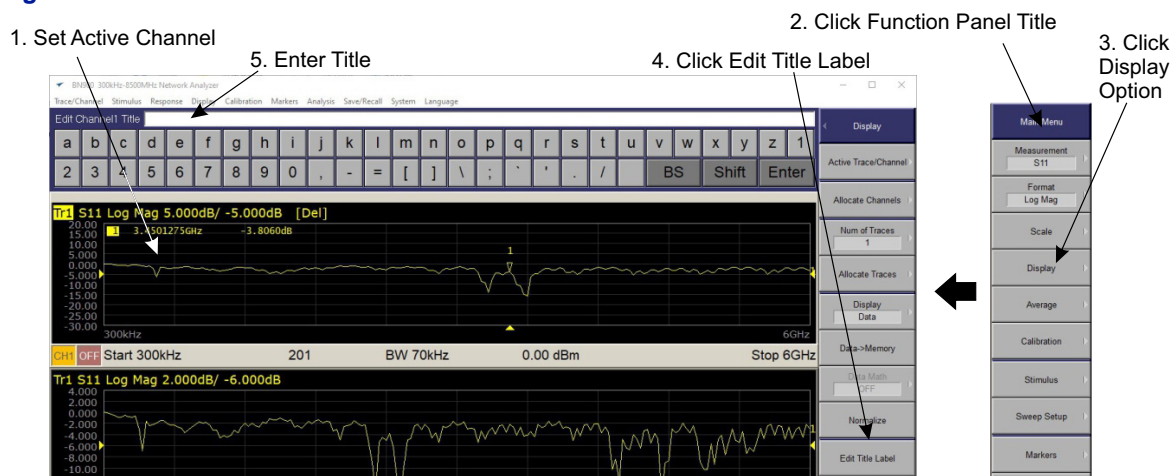

To enable or disable the channel title displayed on the screen:

1. Choose the desired channel or trace to scale.
2. Click on the purple button at the top of the options presented at the right-hand side of the screen until reaching 'Main Menu'.
3. Click the **Display** option on the function panel.
4. Click the **Title Label** function button.
A " • " symbol will appear if the function is active; otherwise, the window title will not be displayed.

Figure 36 Enable Title Label

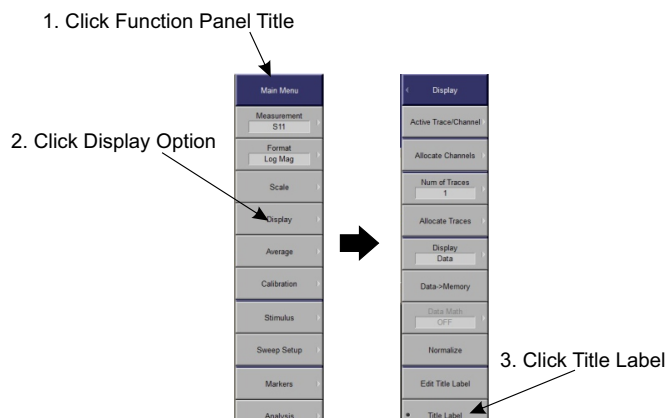

Update

To conserve processing time required for updating on-screen display information, you can deactivate the update function. This action enhances measurement speed on the analyzer.

To change the Update setting:

1. Click **Display Menu**
2. Click **Display** option.
3. Use the **Update** button to toggle the state:
 - ON for continuous measurement updates
 - OFF for static display of the last swept measurement

When off, this state will be reflected in the status bar at the bottom of the screen, as shown in [Figure 37](#).

Figure 37 Display Update Frequency

1. Click Display Menu

2. Click Display Option



The Bird VNA has built in automated calibration routines. The VNA is compatible with numerous calibration kits. [Table 4](#) lists the calibration types available within the Bird VNA software.

Table 4 Calibration Type Description

Calibration Type	Use the Standard	Measurement Parameters
No calibration	No	All parameters
Response calibration (Response Open) (Response Short) (Response Through)	Open or Short Load (Optional) Direct Access Isolation	S11 (reflection characteristic of Port 1) S22 (reflection characteristics of 2 ports) S21 (1-way transmission characteristic of 2-port) S12 (1-port 2-direction transmission characteristic)
Enhanced Response (Single Path 2 Port Calibration)	Open / Short / Load Pass through	Port 1-2 (S12, S22) or Port 2-1(S21, S11)
1 Port Calibration	Open / Short /Load	S11 (reflection characteristic of Port 1) S22 (reflection characteristics of Port 2)
2 Port Calibration	Open / Short / Load Pass Through	S11, S21, S12, S22 (All S-parameters for 2 ports)

Channel Error Correction Status

When calibration is completed on a channel, error correction is automatically enabled. Error correction can be enabled and disabled using the function menu, see [Figure 38 on page 37](#).

The error correction status of each channel is displayed in the bottom left corner of the channel window ([Figure 38](#)). The symbols used to indicate the error correction status are shown in [Table 5](#).

Table 5 Channel Error Correction Status indicators





Symbol	Image	Error Correction Status
OFF (White lettering on red background)		Error correction: OFF
Cor (Black lettering on gray background)		Error correction: ON Error correction is applied for all traces.
Cor (White lettering on red background)		Error correction: ON Error correction is applied to some traces within the channel (see " Trace Calibration Status Indicator " on page 37).
--- (White dashed line on red background)		Error correction: ON No calibration data available.
C? (Black lettering on gray background)		Error correction: ON Execution of interpolation or IF bandwidth, power level, power range, scan time, scan delay, scan mode or scan type is different from when the calibration was performed.

Figure 38 Channel Calibration Status Examples



Trace Calibration Status Indicator

When calibration correction is enabled, a symbol indicating the calibration type is appended to the information string for each trace, see [Figure 39 on page 37](#). If no symbol is visible, the error correction is not enabled.

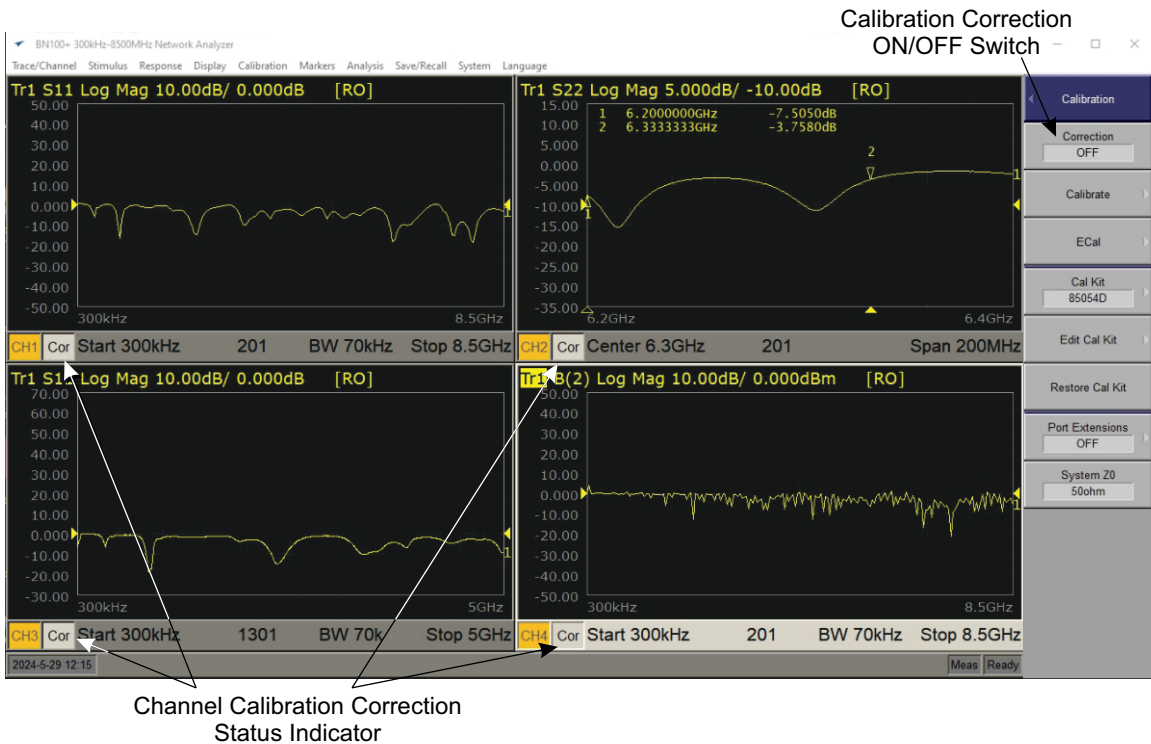
[Table 6](#) provides a list of symbols that may be displayed with a trace. The symbol displayed will be directly associated with the type of calibration that was performed.

Table 6 Trace Calibration Status Indicator

Symbol	Calibration Type
RO	Open circuit response calibration
RS	Short circuit response calibration
RT	Through response calibration
F1	Full 1 Port calibration
OP	Enhance Response (Single path 2 port calibration)
F2	Full 2 Port calibration

Figure 39 Trace Calibration Status

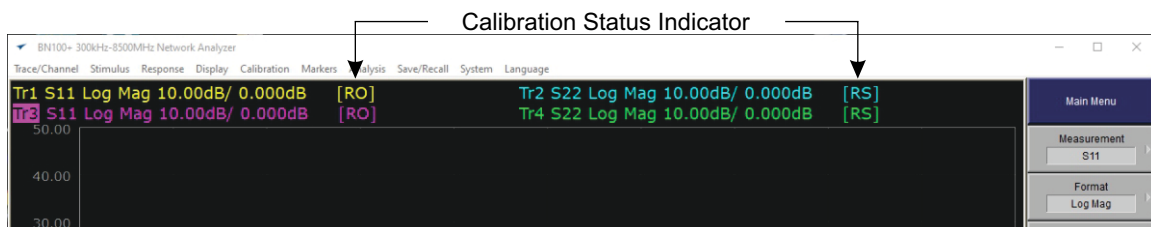

Calibration Process

1. Apply the Channel and Stimulus Settings
To ensure the measurement calibration is optimized to your specific DUT requirements, first select the channel of interest along with the sweep stimulus attributes, defining at least the start and stop frequencies. The number of points, power, and measurement delay may also be of interest depending on the measurement application.

See "[Stimulus](#)" on page 18 for specific details on adjusting channel settings.

2. If required, adjust system Z0 setting to match DUT impedance. See "[Calibration/System Z0](#)" on page 14.
3. Select the Calibration Kit.
Before proceeding with calibration, it is essential to choose the appropriate calibration kit. The instrument offers a wide range of preset calibration kit options available in the function menu.

To select the calibration kit:

- a. Click on the purple button at the top of the options presented at the right-hand side of the screen until reaching 'Main Menu', then select **Calibration**.
- b. Click on the channel that is to undergo calibration.
- c. Click on the **Cal Kit** from the function menu.
- d. Choose the specific model of calibration kit that will be utilized for calibration.

Calibration Kit Parameter Editing

When dealing with non-ideal calibration devices, there are inherent indicators within the device. To enhance calibration accuracy, the instrument utilizes input calibration parameters to calculate calibration correction data. The parameter editing function is used to add or modify these calibration parameters and save them local to the instrument software.

To enter specific calibration standard parameters:

- a. Click the **Calibration** option on the function panel. Click on the purple button at the top of the options presented at the right-hand side of the screen until reaching 'Main Menu'.
 - b. Click the **Cal Kit** function button to choose the appropriate calibration kit option.
 - c. Navigate up one level by clicking the purple **Calibration** button, then click the **Edit Cal Kit** function button to access the calibration parameter editing menu.
 - d. Select the parameters that require editing based on the information provided by whomever characterized the calibration standards.
4. Perform Calibration
 - "[Open-circuit Response Calibration](#)" on page 39
 - "[Short-Circuit Response Calibration](#)" on page 40
 - "[Through Response Calibration](#)" on page 41
 - "[Full 1-Port Calibration](#)" on page 42
 - "[Enhance Response \(Single Channel 2 Port Calibration\)](#)" on page 43
 - "[Full 2-Port Calibration](#)" on page 44

Open-circuit Response Calibration

In open-circuit response calibration, calibration data is acquired by linking the open-circuit standard to the desired test port. For frequency response assessments, these calibrations can significantly mitigate the reflection tracking error of the test device when utilizing the port in reflection tests. The error model is shown in [Figure 40](#).

Figure 40 Open-circuit response calibration

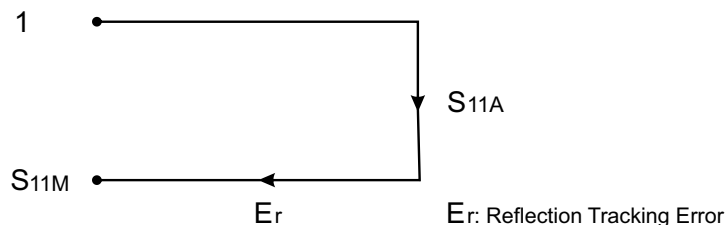

Further, the load standard serves the purpose of isolation calibration within the open-circuit response calibration process. Isolation calibration effectively eliminates the directional error of the test device in reflection tests when utilizing the port. See [Figure 41](#).

Figure 41 Open-circuit response calibration with Isolation

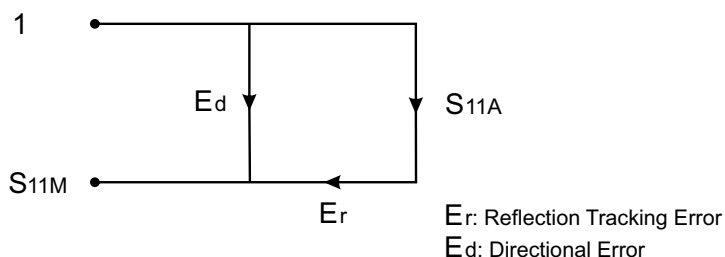

To perform the open-circuit response calibration:

1. Choose the channel that requires calibration. Select the channel either by clicking the desired channel in the display area, or by using the 'Next Channel' or 'Previous Channel' menu options.
2. Click **Calibration** option on the function panel.
Click on the purple button at the top of the options presented at the right-hand side of the screen until reaching 'Main Menu'.
3. Click the **Cal Kit** function button to select the type of calibration kit, then click on the purple button at the top of the options to return up one level.
4. Click the **Calibrate** function button then click the **Response (Open)** function button.
5. Click the **Select Port** function button to pick the port for calibration. Choose between the Port 1 (S11) and Port 2 (S22) options. Ports 3 and 4 (S33 and S44, respectively), are available for specific VNA models. See [Figure 42](#).

Figure 42 Open Response Calibration Connection Diagram

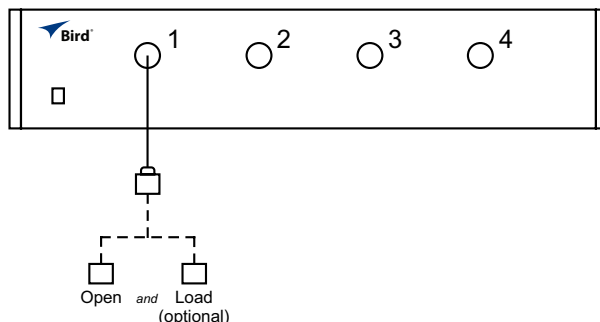

6. Connect the OPEN standard to the chosen port, then click the **Open** function button.

7. Click on either the **Open -M-** or **Open -F-** button depending on the type of connector used by the standard, male or female, respectively, to initiate the calibration process. Upon completion of calibration, a "•" symbol will appear in front of the 'Open' button.
8. (Optional) Attach the LOAD standard to the selected port, then click on the purple button at the top of the options to return up one level, and click the **Load (Optional)** button to commence the load calibration process. Following the completion of calibration, a "•" symbol will be displayed alongside 'Load'.
9. Click the **Done** function button to finalize the calibration.

Short-Circuit Response Calibration

To perform the short-circuit response calibration:

1. Choose the channel that requires calibration. Select the channel either by clicking the desired channel in the display area, or by using the 'Next Channel' or 'Previous Channel' menu options.
2. Click **Calibration** option on the function panel. Click on the purple button at the top of the options presented at the right-hand side of the screen until reaching 'Main Menu', then click **Calibration**.
3. Click the **Cal Kit** function button to select the type of calibration kit, then click on the purple button at the top of the options to return up one level.
4. Click the **Calibrate** function button then click the **Response (Short)** function button.
5. Click the **Select Port** function button to pick the port for calibration. Choose between the Port 1 (S11) and Port 2 (S22) options. Ports 3 and 4 (S33 and S44, respectively), are available for specific VNA models. See [Figure 43](#).

Figure 43 Short-circuit response calibration - DUT connection diagram

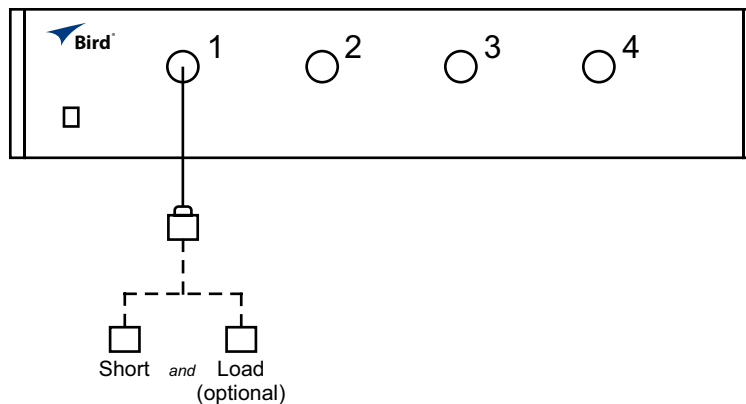

6. Attach the SHORT standard to the chosen port, then click the **Short** function button.
7. Click on either the **Short -M-** or **Short -F-** button depending on the type of connector used by the standard, male or female, respectively, to initiate the calibration process. Upon completion of calibration, a "•" symbol will be displayed in front of the 'Short' button.
8. (Optional) Connect the LOAD standard to the selected port, then click on the purple button at the top of the options to return up one level, and click the **Load (Optional)** button to begin the load calibration process. After calibration is complete, a "•" symbol will appear alongside 'Load'.
9. Click the **Done** function button to finalize the calibration.

Through Response Calibration

In pass-through response calibration, data is measured by interconnecting the pass-through standard between the intended test ports. This calibration technique proves effective in mitigating the frequency response transmission tracking error of the test device during transmission tests using the port. The error model is depicted below:

Figure 44 Through Response Calibration (Direct Response)

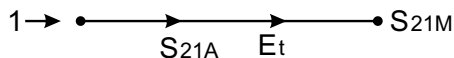

Et: Transmission Tracking Error

Further, in the pass-through calibration process, the load standard can also be employed for isolation calibration. This isolation calibration effectively eradicates the isolation error (crosstalk error) of the test device during transmission tests utilizing this port. The error model is illustrated below:

Figure 45 Through Response Calibration (Direct Response + Isolation)

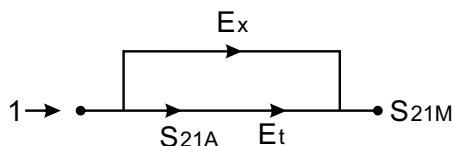

Et: Transmission Tracking Error

Ex: Isolation Error (Crosstalk Error)

To perform the through response calibration:

1. Choose the channel that requires calibration. Select the channel either by clicking the desired channel in the display area, or by using the 'Next Channel' or 'Previous Channel' menu options.
2. Click **Calibration** option on the function panel. Click on the purple button at the top of the options presented at the right-hand side of the screen until reaching 'Main Menu'.
3. Click the **Cal Kit** function button to select the type of calibration kit, then click on the purple button at the top of the options to return up one level.
4. Click **Calibrate** function button then click the **Response (Thru)** function button.
5. Click the **Select Port** function button to pick the port for calibration. Choose between the Port 1 (S11) and Port 2 (S22) options. Ports 3 and 4 (S33 and S44, respectively), are available for specific VNA models. The connections are illustrated below:

Figure 46 Transmission Response Calibration

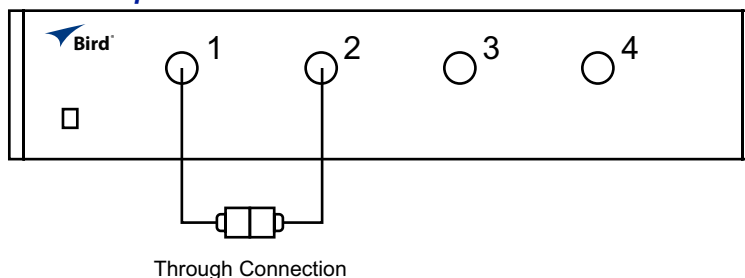

6. Attach the THROUGH standard between the selected ports, then click the **Thru** function button to initiate the through calibration process. Upon completion of calibration, a "•" symbol will be displayed next to 'Through'.
7. (Optional) Attach the LOAD standard to the selected ports and click the **Load (Optional)** button to begin the load calibration process. After calibration is complete, a "•" symbol will appear next to 'Load'.
8. Click the **Done** function button to finalize the calibration.

Full 1-Port Calibration

The full 1-port calibration involves calibrating the data by connecting the OPEN, SHORT, and LOAD standards to the test port of interest. This calibration approach effectively rectifies tracking errors, directional errors, and source matching errors, as depicted below:

Figure 47 Full 1-Port Calibration

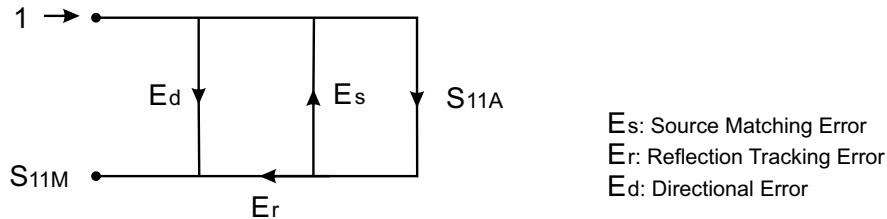

To perform the full 1-port calibration:

1. Choose the channel that requires calibration. Select the channel either by clicking the desired channel in the display area, or by using the 'Next Channel' or 'Previous Channel' menu options.
2. Click **Calibration** option on the function panel. Click on the purple button at the top of the options presented at the right-hand side of the screen until reaching 'Main Menu'.
3. Click the **Cal Kit** function button to select the type of calibration kit, then click on the purple button at the top of the options to return up one level.
4. Click **Calibrate** function button then click the **1-Port Cal** function button.
5. Click the **Select Port** function button to pick the port for calibration. Choose between the Port 1 (S11) and Port 2 (S22) options. Ports 3 and 4 (S33 and S44, respectively), are available for specific VNA models. The connections are illustrated below:"

Figure 48 Full 1-Port Calibration Diagram

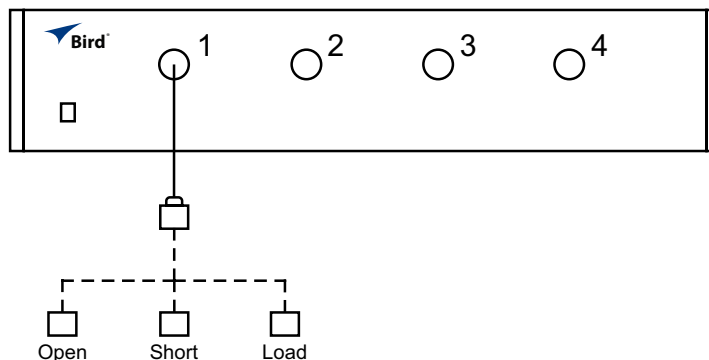

6. Connect the OPEN standard to the chosen port, then click the **Open** function button.
7. Click on either the **Open -M-** or **Open -F-** button depending on the type of connector used by the standard, male or female, respectively, to initiate the calibration process. Upon completion of calibration, a "•" symbol will appear in front of the 'Open' button.
8. Connect the SHORT standard to the chosen port, click on the purple button at the top of the options to return up one level, then click the **Short** function button.
9. Click on either the **Short -M-** or **Short -F-** button depending on the type of connector used by the standard, male or female, respectively, to initiate the calibration process. Upon completion of calibration, a "•" symbol will be displayed in front of the 'Short' button.
10. Connect the LOAD standard to the chosen port, click on the purple button at the top of the options to return up one level, then click the **Load** button to initiate the calibration process. Upon completion, a "•" symbol will appear in front of the 'Load' button.
11. Click the **Done** function button to finalize the calibration.

Enhance Response (Single Channel 2 Port Calibration)

To perform an enhanced response calibration:

1. Choose the channel that requires calibration. Select the channel either by clicking the desired channel in the display area, or by using the 'Next Channel' or 'Previous Channel' menu options.
2. Click **Calibration** option on the function panel. Click on the purple button at the top of the options presented at the right-hand side of the screen until reaching 'Main Menu'.
3. Click the **Cal Kit** function button to select the type of calibration kit, then click on the purple button at the top of the options to return up one level.
4. Click **Calibrate** function button then click the **Enhanced Response** function button.
5. Click the **Select Port** function button to choose the port for calibration. Choose between the **Port 1->2 (S21, S11)** and **Port 1<-2 (S12, S22)** options. For VNA models with additional ports, choose the option that best fits the intended calibration. The connections are as illustrated below:

Figure 49 Enhanced Response

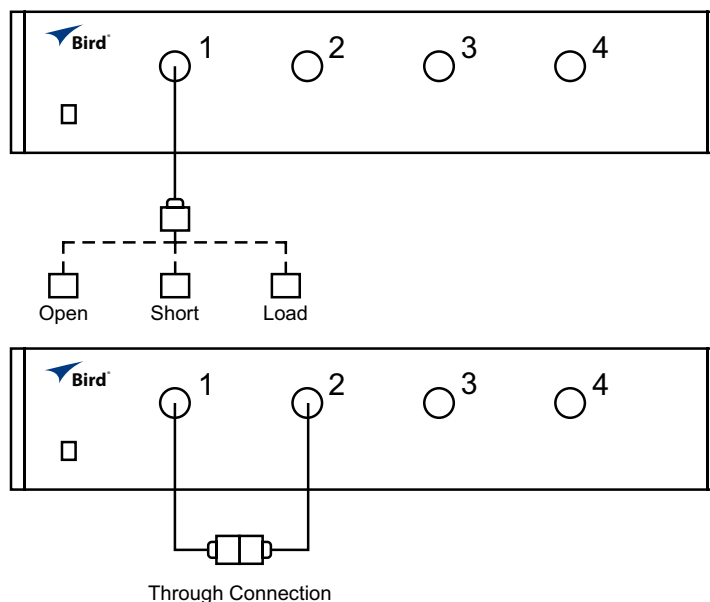

6. Connect the OPEN standard to the chosen port, then click the **Open** function button.
7. Click on either the **Open -M-** or **Open -F-** button depending on the type of connector used by the standard, male or female, respectively, to initiate the calibration process. Upon completion of calibration, a "•" symbol will appear in front of the 'Open' button.
8. Connect the SHORT standard to the chosen port, click on the purple button at the top of the options to return up one level, then click the **Short** function button.
9. Click on either the **Short -M-** or **Short -F-** button depending on the type of connector used by the standard, male or female, respectively, to initiate the calibration process. Upon completion of calibration, a "•" symbol will be displayed in front of the 'Short' button.
10. Connect the LOAD standard to the chosen port, click on the purple button at the top of the options to return up one level, then click the **Load** button to initiate the calibration process. Upon completion, a "•" symbol will appear in front of the 'Load' button.
11. Insert the THROUGH standard between the selected ports, then click the **Thru** function button to start the through calibration process. Upon completion, a "•" symbol will be displayed in front of the 'Thru' button.
12. The isolation part is optional in calibration. If needed, connect the LOAD calibrator to both ports, and click the **Isolation** button. Upon completion of calibration, a "•" symbol will be displayed in front of the 'Isolation' button.
13. Click the **Done** function button to finalize the calibration.

Full 2-Port Calibration

Full 2-port calibration entails calibrating the data through the connection of OPEN, SHORT, LOAD, and THROUGH standards to the test ports. This calibration technique is highly effective in mitigating directional errors, crosstalk, source matching errors, frequency response reflection tracking errors, and frequency response transmission tracking errors. This method yields measurements with the utmost precision, employing a total of twelve error terms in calibration-six each in the forward and reverse directions, as depicted below:

Figure 50 Full 2-Port Calibration

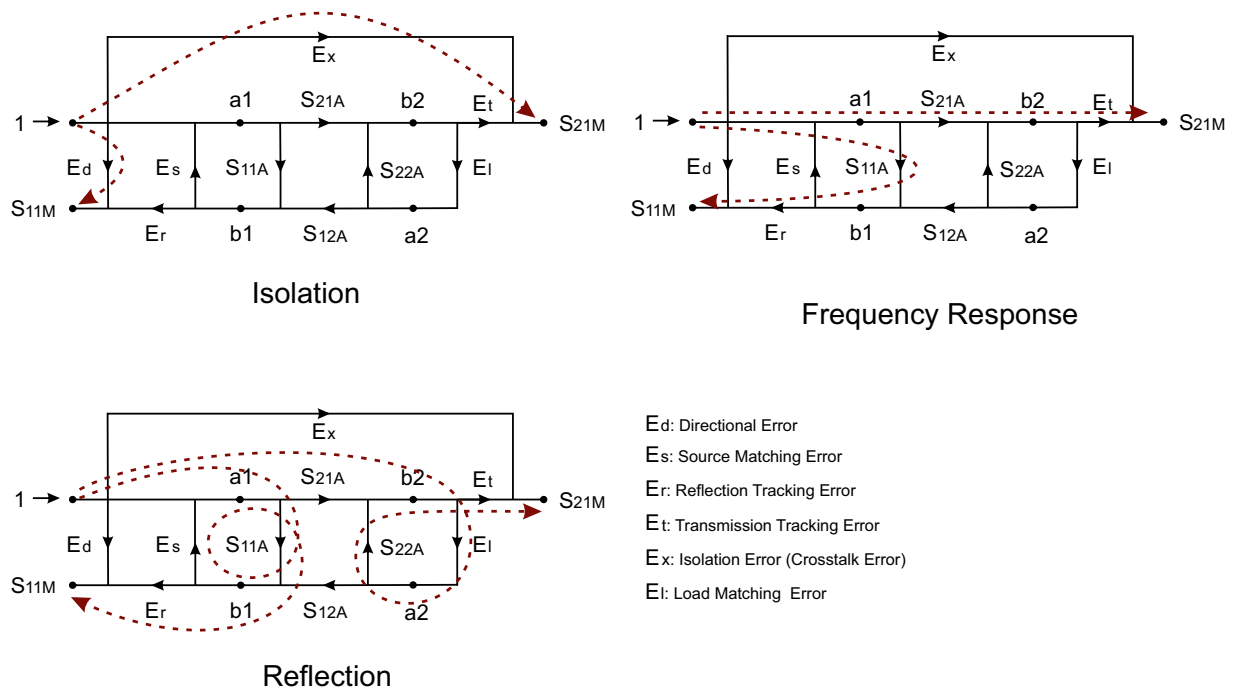

To perform full 2-port calibration:

1. Choose the channel that requires calibration. Select the channel either by clicking the desired channel in the display area, or by using the 'Next Channel' or 'Previous Channel' menu options.
2. Click **Calibration** option on the function panel. Click on the purple button at the top of the options presented at the right-hand side of the screen until reaching 'Main Menu'.
3. Click the **Cal Kit** function button to select the type of calibration kit, then click on the purple button at the top of the options to return up one level.
4. Click **Calibrate** function button then click the **2-Port Cal** function button.
5. (BVNA1000 only) Click the **Select Port** function button to pick the ports for calibration. Choose the option that best fits the intended port calibration combination. The connections are as illustrated [Figure 51 on page 45](#).

Figure 51 Full 2-Port Calibration Connections

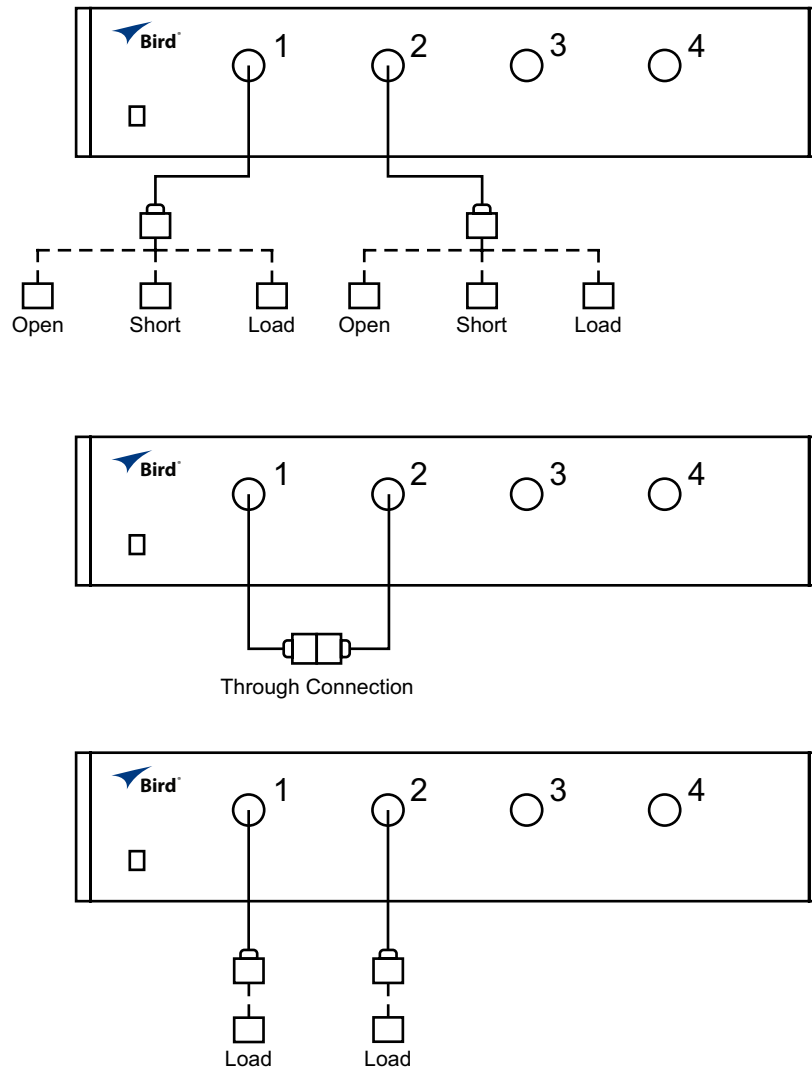

6. Connect the OPEN standard to the chosen first port (for example, Port 1), then click the **Port1 Open** function button.
7. Click on either the **Open -M-** or **Open -F-** button depending on the type of connector used by the standard, male or female, respectively, to initiate the calibration process. Upon completion of calibration, a "•" symbol will appear in front of the 'Open' button.
8. Connect the SHORT standard to the same port, click on the purple button at the top of the options to return up one level, then click the **Port1 Short** function button.
9. click on either the **Short -M-** or **Short -F-** button depending on the type of connector used by the standard, male or female, respectively, to initiate the calibration process. Upon completion of calibration, a "•" symbol will be displayed in front of the 'Short' button.
10. Connect the LOAD standard to the same port, click on the purple button at the top of the options to return up one level, then click the **Port1 Load** button to initiate the calibration process. Upon completion, a "•" symbol will appear in front of the 'Load' button.
11. Repeat [step 6](#) through [step 10](#) for the opposing port.
12. Insert the THROUGH standard between the selected ports, then click the **Thru** function button to start the through calibration process. Upon completion, a "•" symbol will be displayed in front of the 'Thru' button.

13. The isolation part is optional in calibration. If deemed necessary, connect the LOAD calibrator to both ports and click the **Isolation** button. Upon completion of calibration, a "•" symbol will be displayed in front of the 'Isolation' button.
14. Click the **Done** button to complete the calibration.

Select the Trigger Source

When a trigger signal is detected by the trigger source, the corresponding channel is scanned or measured. Measurement for each channel is independent of whether the channel is currently displayed, and activated channels can be measured even if their traces are not visible. For each channel, only the excitation port of the parameter needs to be updated to display the scanned trace.

The trigger source prompts the initiation of the measurement process. There are four trigger source options, see [Table 7](#).

Table 7 Trigger Source Options

Trigger Source	Description
Internal	Use the continuous signal generated by the firmware as the trigger source. The trigger will be sent immediately after each measurement is completed.
External	The external signal is used as the trigger source from the Trig In input.
Manual	Click this on-screen function button to generate the trigger signal. When this option is selected, the 'Trigger' function button becomes enabled (at the same level as the Trigger Source function button) which is used to execute a triggered scan or measurement.
Bus	Trigger via the communication bus: USB, LAN, or GPIB (depending on the options available on the model).

To select the trigger source:

1. Click the **Stimulus** menu.
2. Click the **Trigger** option.
3. On the function menu, click **Trigger Source**.
4. Choose from the four options provided.

Figure 52 Select the Trigger Source



Set the Trigger Mode

Table 8 Trigger Modes

Function Button	Description
Hold	Set the working channel trigger mode to hold the scan mode
Single	Set the working channel trigger mode to single scan mode
Continuous	Set the working channel trigger mode to continuous scan mode
Hold All Channels	Set all channel trigger modes to hold scan mode
Continuous All Channels	Set all channel trigger modes to continuous scan mode

To set the trigger mode:

1. Click **Sweep Setup** on the function menu. Click on the purple button at the top of the options presented at the right-hand side of the screen until reaching 'Main Menu'.
2. Click the **Trigger** function button.
3. Select the desired trigger mode from the list of options, see [Table 8](#).
4. Repeat the above steps to set the trigger mode for each channel.

Trigger Restart Control

The 'Restart' button controls the triggering during the scan. Clicking the 'Restart' button halts the scanning process and then restarts it.

To set the trigger mode:

1. Click **Stimulus Menu**.
2. Click **Trigger** option.
3. Click **Restart** on the function menu panel.

Figure 53 Trigger Restart

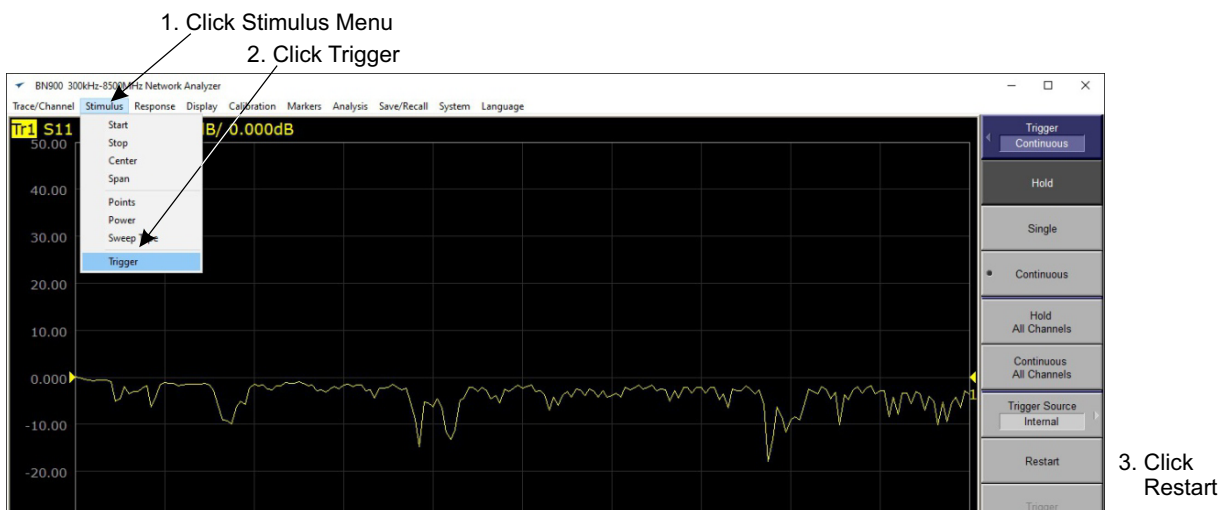

Markers

Marker Overview

The device has the capability to display up to 16 markers. These markers encompass reference markers for each trace line. Each marker is characterized by an X-coordinate value (displayed along the X-axis in Cartesian coordinate format) and a Y-coordinate value (displayed along the Y-axis in rectangular coordinate format). In the context of Smith chart and polar coordinates, each marker features two response values (logarithmic amplitude and phase).

Marker Display

Cartesian Format

In Cartesian display format, the marker response value aligns with the Y-axis data format consistently.

Polar Coordinate/Smith Chart Format

For both polar and Smith chart formats, response values (both primary and secondary) can be marked using various types. The data formats for polar coordinates and Smith charts are outlined in [Table 9](#).

Table 9 *Smith Chart, Polar Coordinate Data Formats*

Data Format	Responder	
	Principal Value	Auxiliary Value
Smith - Lin / Phase	Linear Amplitude	Phase
Smith - Log / Phase	Logarithmic Amplitude	Phase
Smith - Real / Imag	Real Component	Imaginary Component
Smith - R + jX	Resistance	Reactance
Smith - G + jB	Conductance	Charge
Polar - Lin / Phase	Linear Amplitude	Phase
Polar - Log / Phase	Logarithmic Amplitude	Phase
Polar - Real / Imag	Real Component	Imaginary Component

Marker Operation

Add Marker

To add a marker to channels in Cartesian, polar, or Smith display format:

1. Choose the channel where the marker will be added. Select the channel either by clicking the desired channel in the display area, or by using the 'Next Channel' or 'Previous Channel' menu options.
2. Click **Markers** Menu. Alternatively, click on the purple button at the top of the options presented at the right-hand side of the screen until reaching 'Main Menu', then select **Markers** function button.
3. Click **Add Marker**.
4. Adjust the marker frequency:
 - Use the Data Entry Bar to type in the exact frequency value then click the **OK** button (Figure 54).
 - Use the mouse to click on and drag the marker left or right to the frequency of interest.
5. Repeat steps 1 through 4 to add additional markers.

Figure 54 Add Marker Dialog Box

1. Set Active Channel

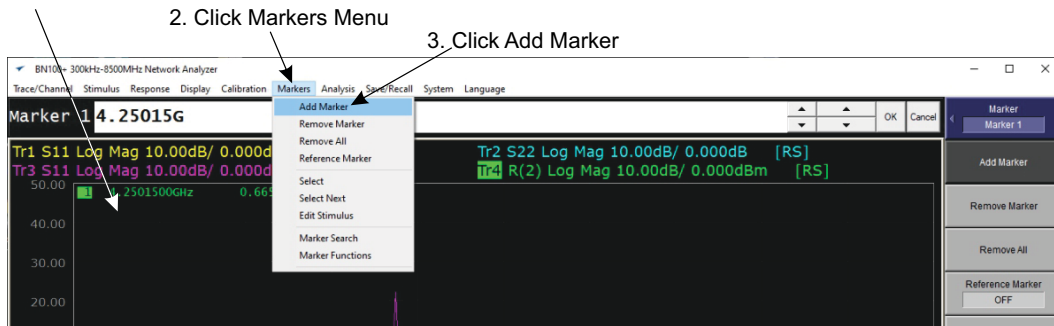

4. Adjust Marker Value

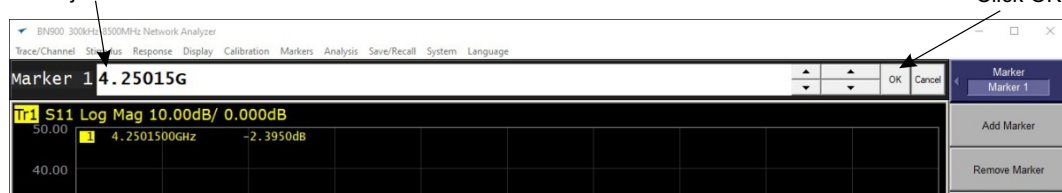

Delete Marker

To delete a marker:

1. Choose the channel where the marker will be deleted. Select the channel either by clicking the desired channel in the display area, or by using the 'Next Channel' or 'Previous Channel' menu options.
2. Select the marker to be deleted.
3. Click **Markers** Menu. Alternatively, click on the purple button at the top of the options presented at the right-hand side of the screen until reaching 'Main Menu', then select **Markers** function button.
4. Click **Remove Marker**.
5. Alternatively, all markers on screen can be removed by clicking the **Remove All** function button.

Reference Marker

The reference marker enables the observation of data in relation to a designated reference point - an enabled marker or markers. When the reference marker is turned on, readings from other markers are displayed as deltas relative to this reference marker. The reference marker presents absolute data and is denoted by the symbol "R" at the trace instead of a numerical value. Activating a reference marker transitions all other markers into a relative display mode.

To enable or disable the reference marker:

1. Click **Marker** option on the function menu. Click on the purple button at the top of the options presented at the right-hand side of the screen until reaching 'Main Menu', then select **Markers** function button.
2. Click on **Reference Marker** to either enable (status ON) or disable (status OFF). [Figure 55](#) shows a representation of a reference marker display.

Figure 55 Reference Marker

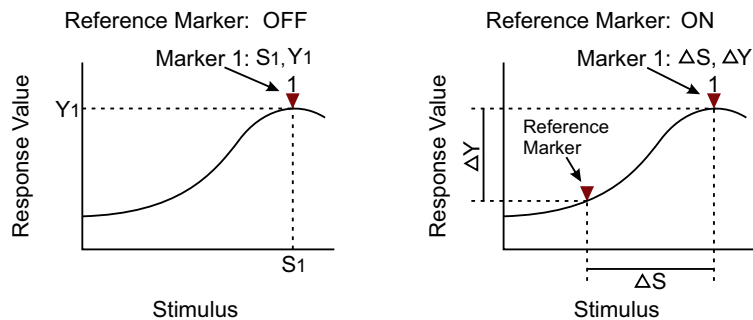

Modify the Marker Position Value

To change the position of a given marker:

1. Choose the channel containing the marker to be modified. Select the channel either by clicking the desired channel in the display area, or by using the 'Next Channel' or 'Previous Channel' menu options. See [Figure 56 on page 51](#).
2. Click **Markers** menu. Alternatively, click on the purple button at the top of the options presented at the right-hand side of the screen until reaching 'Main Menu', then select **Markers** function button.
3. Click **Select**.
4. On the function panel, click on the marker you want to modify.
5. Using the Data Entry Bar, input value to which the marker needs to be set and click **OK**.

NOTE

The mouse may be used to drag the marker to a new location, click on the marker and drag it left or right to the frequency of interest.

Figure 56 Change Marker Frequency Position

1. Set Active Channel

2. Click Markers Menu

3. Click Select

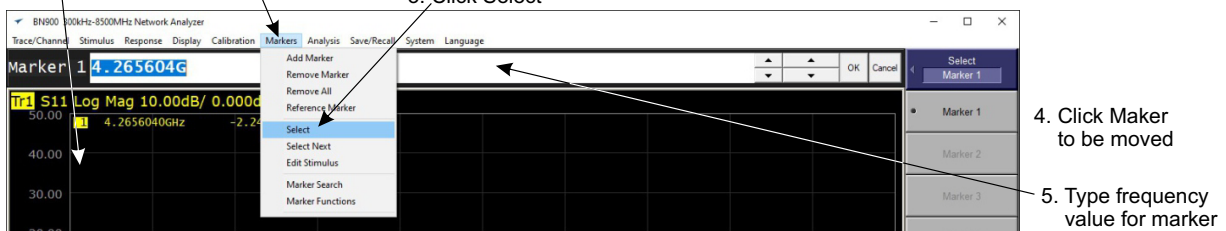

4. Click Marker to be moved

5. Type frequency value for marker

Marker Search

Search the Maximum Value

Applying a search for the maximum value of a trace will identify the point within the frequency sweep where the measured value is at its highest point.

To perform a maximum search using a marker on a trace:

1. Choose the trace holding the marker of interest. Select the trace either by clicking the desired trace in the display area, or by using the 'Next Trace' or 'Previous Trace' menu options.
2. Click **Markers** menu.
3. Navigate to the marker selection in one of the following ways:
 - Use the menu bar to navigate to **Markers->Marker Search**, or
 - Click on the purple button at the top of the options presented at the right-hand side of the screen until reaching 'Main Menu', then select **Markers** function button followed by **Marker Search**.
4. Select the **Maximum** function button. The marker will automatically move to maximum measured value in the trace as shown in [Figure 57](#).

Figure 57 Marker Value Search Max

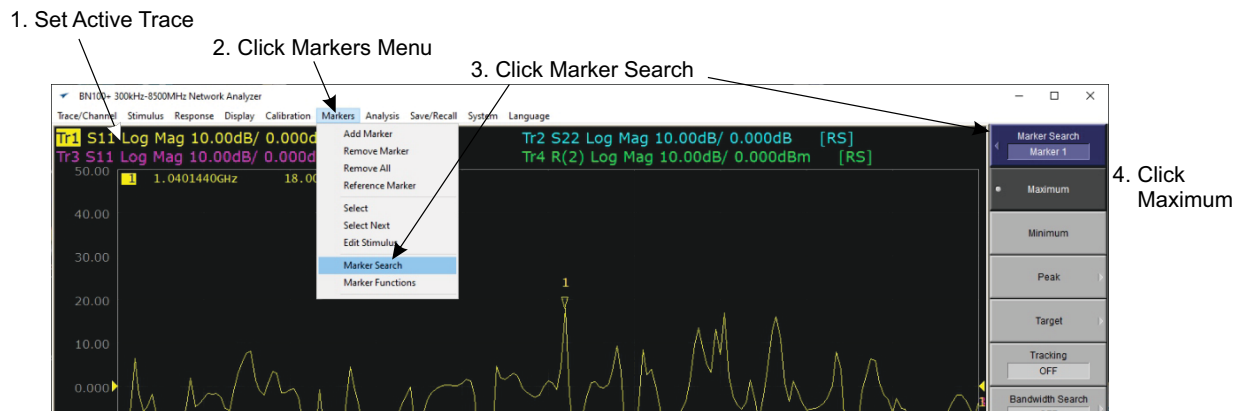

Search the Minimum Value

Applying a search for the minimum value of a trace will identify the point within the frequency sweep where the measured value is at its lowest point.

To perform a minimum search using a marker on a trace:

1. Choose the trace holding the marker of interest. Select the trace either by clicking the desired trace in the display area, or by using the 'Next Trace' or 'Previous Trace' menu options.
2. Click **Markers** menu.
3. Navigate to the marker selection in one of the following ways:
 - Use the menu bar to navigate to **Markers->Marker Search**, or
 - Click on the purple button at the top of the options presented at the right-hand side of the screen until reaching 'Main Menu', then select **Markers** function button followed by **Marker Search**.
4. Select the **Minimum** function button. The marker will automatically move to minimum measured value in the trace as shown in [Figure 58 on page 53](#).

Figure 58 Marker Value Search Min

1. Set Active Trace

2. Click Markers Menu

3. Click Marker Search

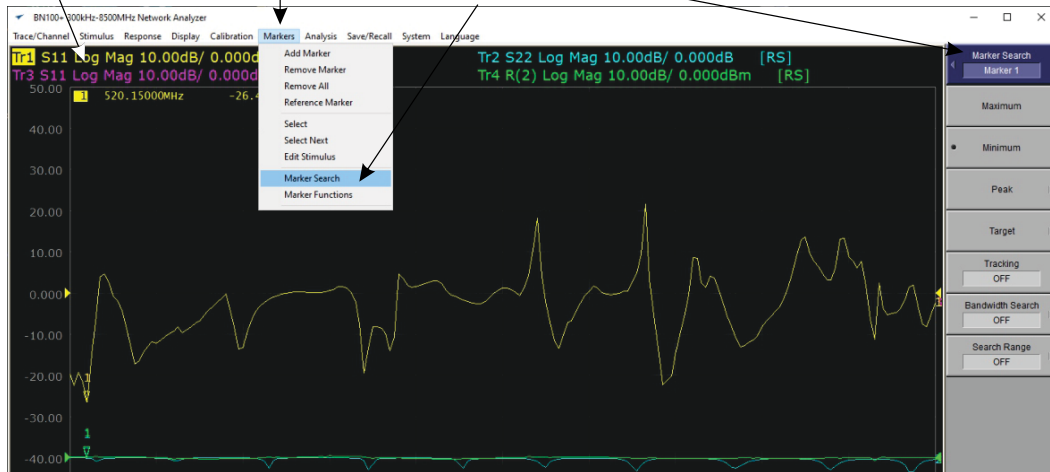

4. Click Minimum

NOTE

When the data format is a Smith chart or Polar coordinate, only the primary response value is searched.

Search Target Value

Utilize the target search function to relocate the marker to a point along a trace where measurement value yields the closest match to the indicated target value that aligns with the defined target transition type. Based on the type of transition, the target can be categorized into two groups, as shown in [Table 10](#).

Table 10 Target Transition

Target Transition	Description
Positive Transfer	Moving from lowest frequency to highest (left to right on screen), the value of the target is located where the trace holds a positive slope (where the measured value on the right is greater than the measured value on the left).
Negative Transfer	Moving from lowest frequency to highest (left to right on screen), the value of the target is located where the trace holds a negative slope (where the measured value on the right is less than the measured value on the left).

Figure 59 Target Transfer Category

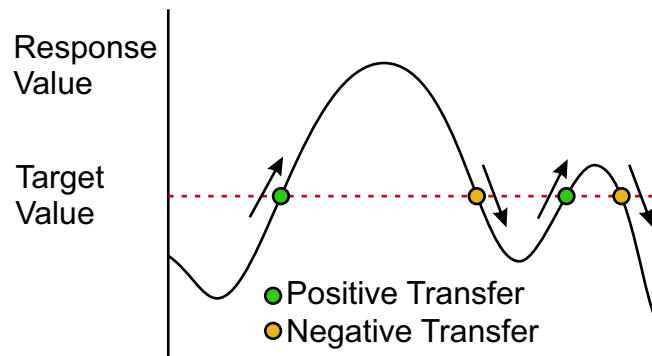

The operator can choose either positive or negative transitions (or transfers) to search against, or they can opt to search for both.

Once a Target Value and Transition is defined, the operator can choose one of the three options in [Table 11](#) to search for the value.

Table 11 Target search category

Search Category	Description
Search Target	Moves the marker to the target value. If there are multiple points at or near the target value and the transition is set to "Both", the closest location to the present marker location will be chosen.
Search Left	Moves the marker from its current position to the first target value encountered at a lower (frequency) stimulus value.
Search Right	Moves the marker from its current position to the first target value encountered at a higher (frequency) stimulus value.

Figure 60 Target Search Category

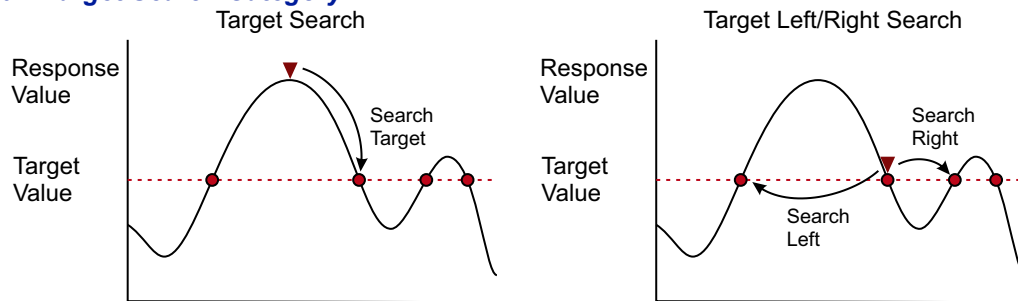

To search for a Target Value:

1. Choose the trace holding the marker of interest. Select the trace either by clicking the desired trace in the display area, or by using the 'Next Trace' or 'Previous Trace' menu options.
2. Navigate to the marker search in one of the following ways:
 - Use the menu bar to navigate to **Markers->Marker Search**, or
 - Click on the purple button at the top of the options presented at the right-hand side of the screen until reaching 'Main Menu', then select **Markers** function button followed by **Marker Search**.
3. Click on the **Target** function button.
4. Click on the **Target Value** function button. Using the Data Entry Bar, input value to which the marker needs to be set and click **OK**.
5. Click on the **Target Transition** function button. Choose from the **Positive**, **Negative**, or **Both** options.
6. (Optional) Click on the **Target Line** function button to enable or disable the horizontal reference line representing the target value and shown across the trace viewing area.
7. Click the **Search Target** or **Search Target Left** or **Search Target Right** to search target value as per requirement.

Figure 61 Search Target Value

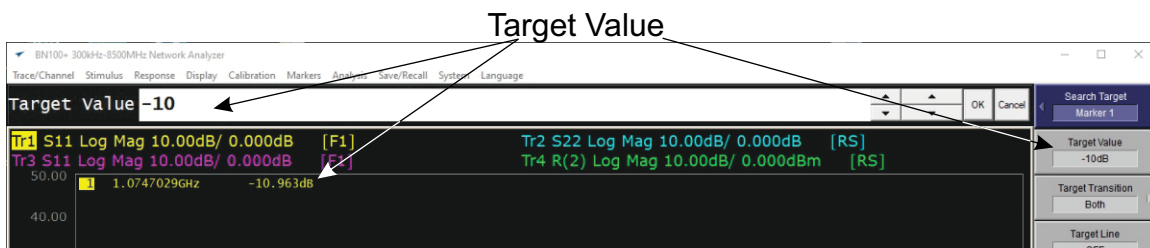

Search Peak

Use the peak search function to move the marker to the peak on the trace. The options for the peak search are shown in [Table 12](#).

Table 12 Peak Search Polarity Options

Peak Polarity	Description
Positive Peak	Moving from lowest frequency to highest (left to right on screen), a positive peak is a measured value that is greater than all others in a region where the trace exhibits a positive slope (or positive peak polarity).
Negative Peak	Moving from lowest frequency to highest (left to right on screen), a negative peak is a measured value that is less than all others in a region where the trace exhibits a negative slope (or negative peak polarity).
Both	Positive or Negative peak

Table 13 Peak Search Category

Peak Search Category	Description
Search Peak	When the peak polarity is set to "Positive" or "Both", the active marker will move to the maximum peak point found across the defined frequency span. When the peak polarity is set to "Negative", the active marker will move to the minimum peak point found across the defined frequency span.
Search Left	Searches from the current marker position to the peak at a smaller frequency stimulus value (moving left across the trace measurements), locating the first peak encountered. The peak identified will be determined by the peak polarity setting.
Search Right	Searches from the current marker position to the peak at a larger frequency stimulus value (moving right across the trace measurements), locating the first peak encountered. The peak identified will be determined by the peak polarity setting, and then moves the marker to the first peak encountered.

Figure 62 Peak Search

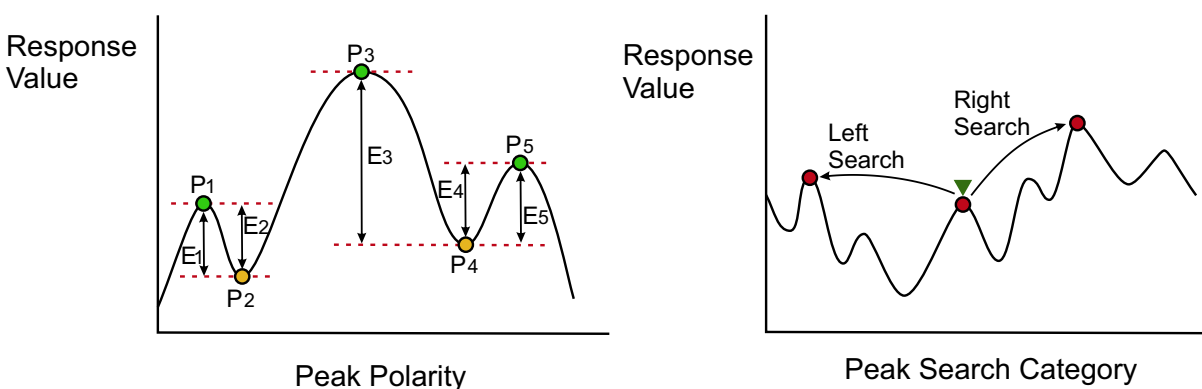

To perform a peak search:

1. Choose the trace holding the marker of interest. Select the trace either by clicking the desired trace in the display area, or by using the 'Next Trace' or 'Previous Trace' menu options t.
2. Navigate to the marker search in one of the following ways:
 - Use the menu bar to navigate to **Markers->Marker Search**, or
 - Click on the purple button at the top of the options presented at the right-hand side of the screen until reaching 'Main Menu', then select **Markers** function button followed by **Marker Search**.
3. Click on the **Peak** function button.
4. Click on the **Peak Polarity** function button. Choose from the **Positive**, **Negative**, or **Both** options.
5. (Optional) Click on the **Peak Excursion** function button. The peak excursion is defined as the minimum absolute difference between the response values at the peak point and those at the two adjacent peaks with opposite polarity: essentially the drift between the adjacent points of a possible peak. Using the Data Entry Bar, input the value and click **OK**. See [Figure 63](#).
6. Click the **Search Peak** function button to search for peaks.
7. Click the **Search Peak Left** function button to search for a peak to the left of the marker. Click again to continue the search in the same direction.
8. Click the **Search Peak Right** function button to search for a peak to the right of the marker. Click again to continue the search in the same direction.

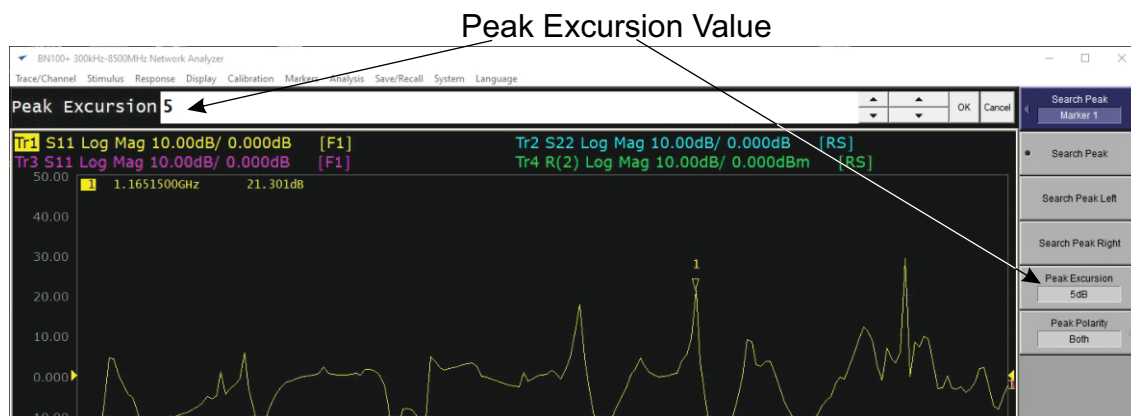
Figure 63 Peak Excursion Value**Search Tracking**

The search tracking function sets the search to repeat the search every time a scan is performed or triggered. The behavior is most noticeable when manual triggering is performed, with the search point of interest getting updated with each trigger initiation. (Similar behavior occurs with continuous triggering, but in a far more rapid manner.) This function makes it easy to observe the measurement results such as the Marker Search.

Click the **Tracking** function button to turn the tracker ON or OFF.

Bandwidth Search

Bandwidth search is most applicable while measuring bandpass and notch filters, helping the operator to quickly identify the bandwidth, center frequency, the cutoff points (the higher and lower side frequencies), Q, and the insertion loss according to the position of the working marker. The parameters applied for the bandwidth search are shown [Figure 64](#).

Figure 64 Bandwidth Search Parameter Definition--- Bandpass Filter

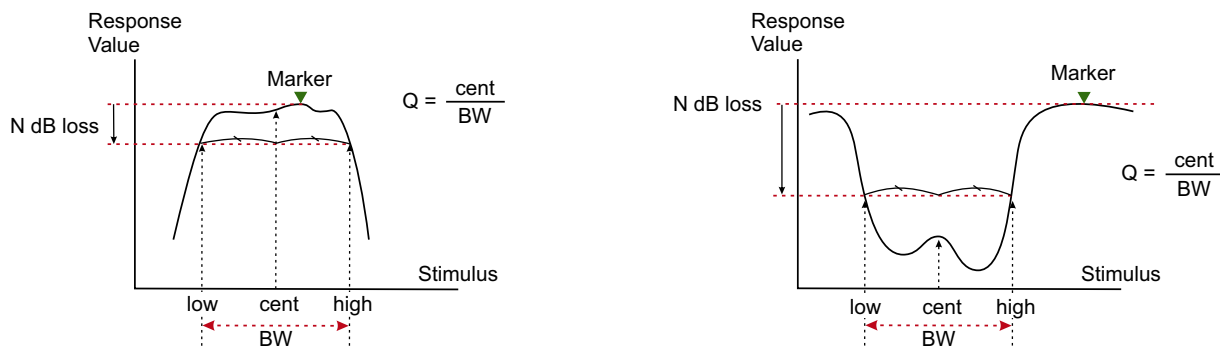

See [Table 14](#) for the definition of the parameters defined for the bandwidth search.

Table 14 Bandwidth Parameters

Bandwidth Parameters	Description
Insertion loss	When performing a bandwidth search the measured value at the working marker (while the Search Ref To function is set to "Marker") or the maximum value (while the Search Ref To function is set to "Max")
Lower frequency cutoff point	The lower frequency point as determined by the working marker measurement and the applied Bandwidth Value.
Higher frequency cutoff point	The higher frequency point as determined by the working marker measurement and the applied Bandwidth Value.
Center frequency	The frequency halfway between the higher and lower frequency cutoff points: $cent = (high + low) / 2$
Bandwidth	The frequency difference between the higher frequency cutoff point and the lower frequency cutoff point: $BW = (high - low)$
Q	The quality factor which is defined as center frequency divided by the bandwidth: $Q = (cent / BW)$

To apply the Bandwidth Search:

1. Choose the trace holding the marker of interest. Select the trace either by clicking the desired trace in the display area, or by using the 'Next Trace' or 'Previous Trace' menu options.
2. Navigate to the marker search in one of the following ways:
 - a. Use the menu bar to navigate to **Markers->Marker Search**, or
 - b. Click on the purple button at the top of the options presented at the right-hand side of the screen until reaching 'Main Menu', then select **Markers** function button followed by **Marker Search**.
3. Click **Bandwidth Search** function button.
4. Click on the **Type** function button to select the filter type, either **Bandpass** or **Notch** depending on the device.
5. Click the **Bandwidth Value** function button and input the bandwidth value in data entry bar and click **OK**.
6. Click the **Bandwidth Search** function button to turn the search ON to apply the bandwidth search measurement as [Figure 65 on page 57](#). Toggling the button to OFF will remove the bandwidth search measurement.

Figure 65 Bandwidth Search for Measurement Results

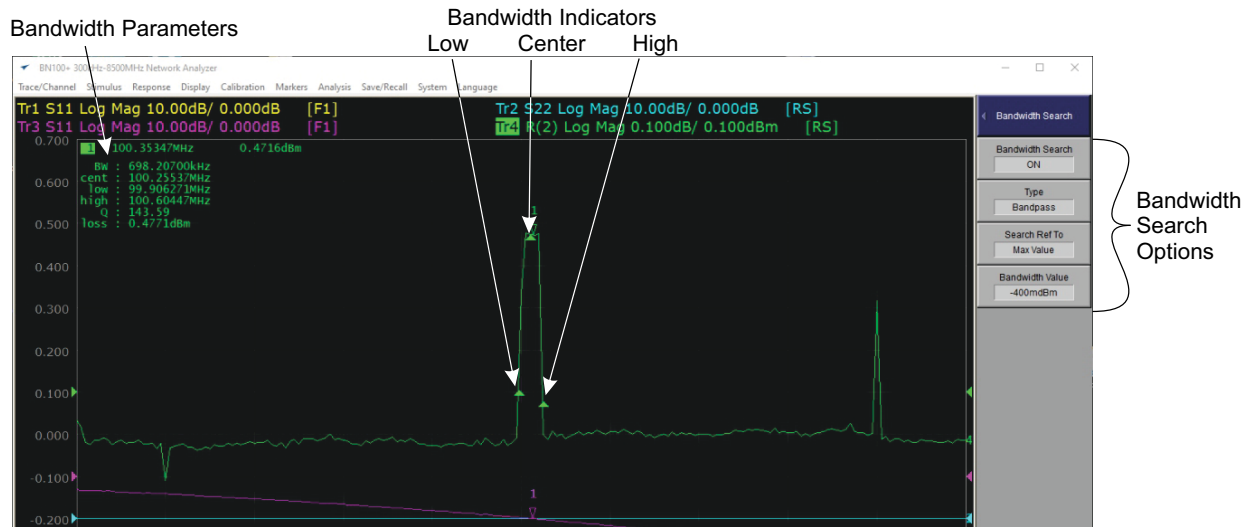

Search Range

Use the search range function to perform a focused target search on a partial scan range within the swept frequency range. As needed, the operator may also choose to:

- Show vertical limit lines indicative of the search range boundary.
- Establish multiple search ranges.
- Apply the search range coupling feature to use the same search range across all traces defined for a channel.

To configure the search range:

1. Choose the trace holding the marker of interest. Select the trace either by clicking the desired trace in the display area, or by using the 'Next Trace' or 'Previous Trace' menu options.
2. Navigate to the marker search in one of the following ways:
 - Use the menu bar to navigate to **Markers->Marker Search**, or
 - Click on the purple button at the top of the options presented at the right-hand side of the screen until reaching 'Main Menu', then select **Markers** function button followed by **Marker Search**.
3. Click **Search Range** function button.
4. Click the gray **Search Range** function button to ON to enable the search range option. Toggling the button to OFF will disable the search range function.
5. Click on the **Search Start** function button and use the Data Entry Bar to input the frequency value to which the marker needs to be set and click **OK**.
6. Click on the **Search Stop** function button and use the Data Entry Bar to input the frequency value to which the marker needs to be set and click **OK**.
7. (Optional) Click on **the Search Range Lines** to enable the vertical limit lines that denote the selected search start and stop frequencies.
8. (Optional) Click on **Couple** to apply the same start and stop search range frequencies to all other active traces for the channel.
9. (Optional) To establish a series of search ranges:
 - Click on the **Multiple Range** function button.
 - Click on **Multiple Range** to toggle its state to ON.
 - Click on **Target Range** and select from the available range numbers (1 through 16).
 - Follow [step 5](#) and [step 6](#) to apply new, additional search ranges as needed.
10. Click the purple function button at the top of the right hand on-screen column to return to the **Marker Search** function options and execute any of the search actions available as outlined in the previous sections.

Figure 66 Search Range

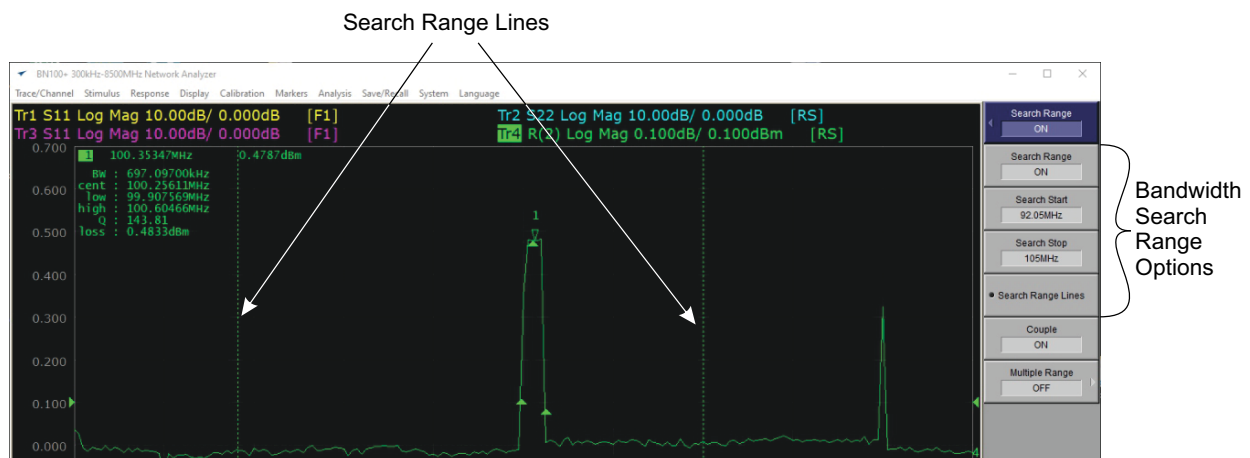

Marker Function

Marker Transfer Setting

Use the Marker value to set the scan range. A convenient way of adjusting stimulus settings is through the use of marker locations.

When adjusting the start stimulus point for the scan, the stop point will remain the same and the position of the selected marker will be used as the new start stimulus point. An illustration of what this change may look like is shown in [Figure 67](#).

To set the scan start with the marker:

1. From the menu bar navigate to **Markers->Marker Functions**.
2. Click on the **Marker-> Start** function button to set the start value of the scan range.

Figure 67 Marker Transfer --- Marker -> Start Function

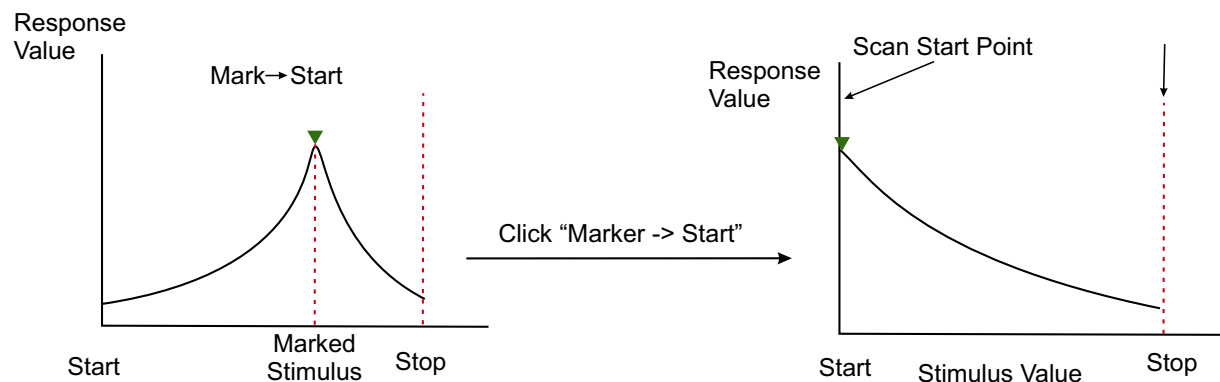

When adjusting the stop stimulus point for the scan, the start point will remain the same and the position of the selected marker will be used as the new stop stimulus point. An illustration of what this change may look like is shown in [Figure 68](#).

To set the scan stop with the marker:

1. From the menu bar navigate to **Markers->Marker Functions**.
2. Click on the **Marker-> Stop** function button to set the start value of the scan range.

Figure 68 Marker Transfer --- Marker -> Stop Function

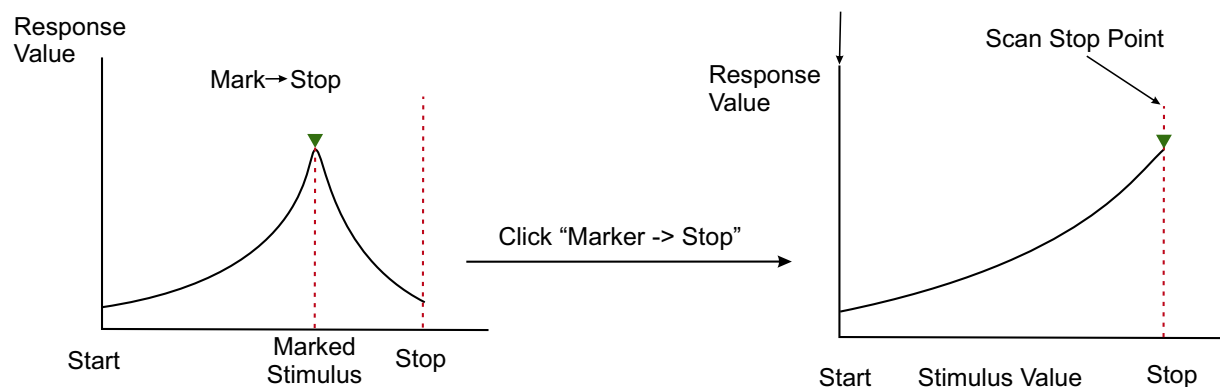

When adjusting the scan using the center point option, the start point will remain the same and the difference between the selected marker position and the start point will be doubled and used as the new stimulus span with the stop point set to the end. An illustration of what this change may look like is shown in [Figure 69](#).

To set the scan span with the marker and center option:

1. From the menu bar navigate to **Markers->Marker Functions**.
2. Click on the **Marker-> Center** function button to set the stop value of the scan range and the effective stimulus span.

Figure 69 Marker Transfer --- Marker -> Center Function

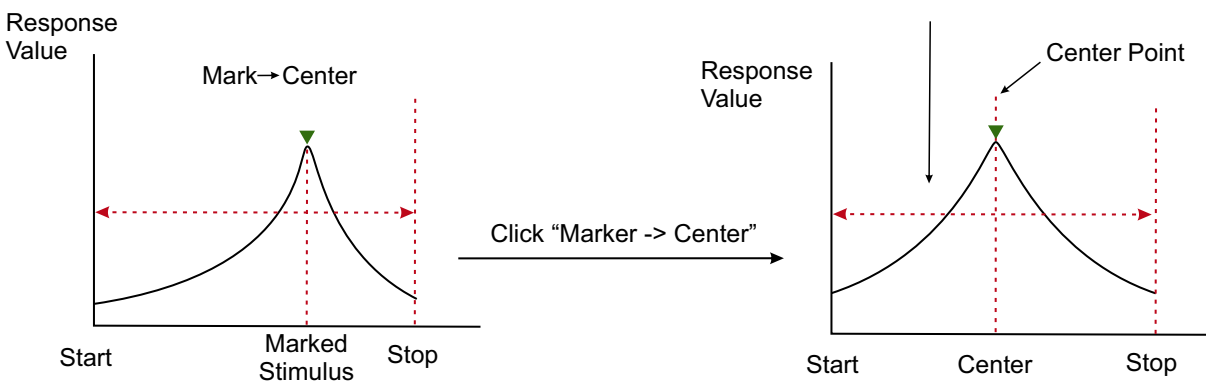

NOTE

If the reference marker is enabled and the stimulus value of the working marker is represented as relative to the reference marker, the absolute stimulus value is employed to establish the new sweep range.

Use the marker to set the reference line value

When using Cartesian display format, the value of the reference line can be changed so that it is equal to the response value of the working marker on the job trace.

To adjust the reference value using the marker:

1. From the menu bar navigate to **Markers->Marker Functions**.
2. Click on the **Marker-> Ref Value** function button to change the value of the reference line to the tag response value.

NOTE

If the reference marker is active and the stimulus value of the working marker is expressed as relative to the reference marker, the absolute reference value will be determined using the absolute stimulus value.

Use the marker to set the electrical delay

For information on "Electrical Delay", see ["Electrical Delay" on page 83](#).

To adjust the electrical delay using the working marker:

1. From the menu bar navigate to **Markers->Marker Functions**.
2. Click on the **Marker-> Electrical Delay** function button to set the group delay value of the marker as the **Scale->Electrical Delay** value.

NOTE

The value of the markers is measured based on group delay, which is applicable when the format of the trace containing the marker is set to Group Delay. If the reference marker is enabled and the value of the working marker is relative, the value of the reference marker dictates that the transfer setting value will be utilized in absolute terms.

Marker Coupling Set

The coupling is used to set and move the markers individually or independently for each trace. An illustration of what this change may look like is shown in [Figure 70](#).

The method of setting the coupling state is as follows:

1. From the menu bar navigate to **Markers->Marker Functions**.
2. Click on the **Marker-> Couple** button. When its state is set to ON then coupling is enabled, when its state is set to OFF then coupling is disabled.

Figure 70 Marker Coupling Setting

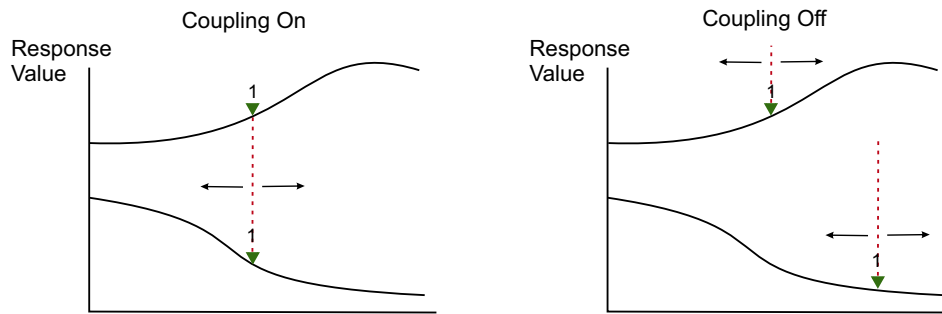

List the Marker/Tag Values for All Channels

All channel and trace marker information can be presented in tabulated list format within the VNA software interface. This function is used to list all the marker values in all channels on screen. The marker display table is shown in [Figure 71 on page 62](#).

To access the marker table:

1. From the menu bar navigate to **Markers->Marker Functions**.
2. Click on the **Marker Table** button to toggle the table state. ON will display the marker table and OFF will conceal it

Figure 71 Marker Table

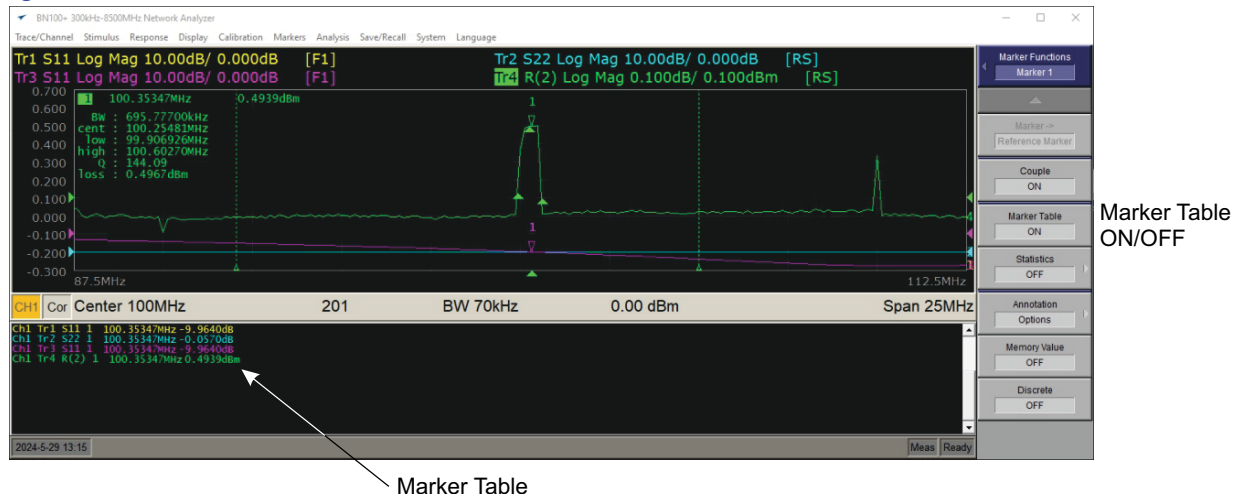

Marker Statistics

The Marker Statistics function is used to determine and show the statistics of the traces such as span, mean, standard deviation and peak-to-peak. The definition of statistical data elements is shown in [Figure 15 on page 63](#).

Table 15 Marker Statistical Data Elements

Statistical Data Element	Description
Span	The frequency span between any two markers when more than one is available. (Examples: 1 & 2, 1 & 3, 1 & 4, etc.)
Mean	$\frac{\sum_{i=1}^n X_i}{n}$ n = the number of points X _i = the measured value at the i-th measurement point
s. dev	$\sqrt{\frac{\sum_{i=1}^n (X_i - \text{mean})^2}{n - 1}}$ n = the number of points X _i = the measured value at the i-th measurement point mean = average value
p-p	Max-Min (Max = maximum measured value & Min = minimum measured value). Note: when only one marker is available or both the start and stop markers are defined as the same, the peak-to-peak value is 0.

To work with marker statistics:

1. From the menu bar navigate to **Markers->Marker Functions**.
2. Click the **Statistics Start** and **Statistics Stop** button to select marker to set the start marker and stop marker for the statistics range.
3. Click the **Statistics Range ON/OFF** function button to activate or deactivate the statistics range. When its state is set to ON it means the statistical range is activated and when its state is set to OFF it means the statistical range is deactivated.
4. Click the **Statistics ON/OFF** function button to show or remove the statistical data on screen.

Figure 72 Marker Statistics

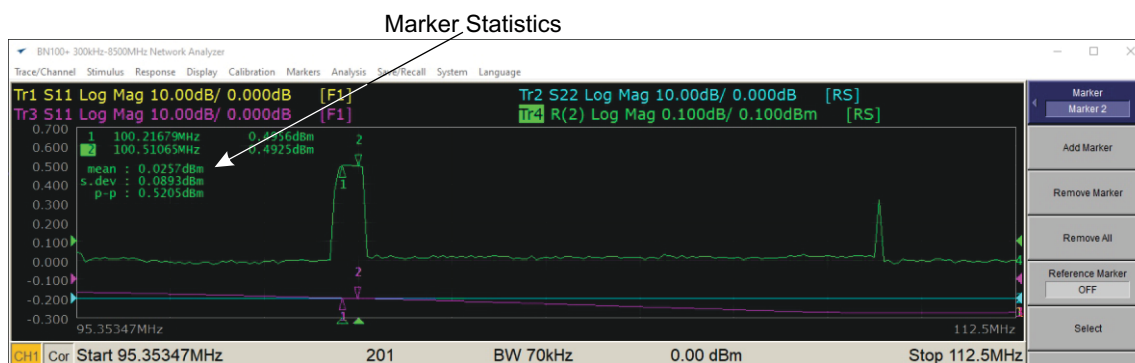

Display the Marker Point Values for All Traces

When there are multiple traces in the trace window, the marker point on-screen annotated information for available traces can be displayed.

To toggle the annotated information for all traces:

1. From the menu bar navigate to **Markers->Marker Functions**.
2. Click on the **Annotation [Options]** function button.
3. Click **Active Only** function button to toggle annotation for all markers across available traces.
 - When the symbol "•" appears next to Active Only, it will only show the marker values for the selected trace.
 - When there is no "•" symbol then all the marker values for all traces present in selected channel will be shown.

Adjust the Format or Position of the Displayed Marker Values

To aid with viewing and visual presentation, the on-screen marker values can be repositioned and resized on the screen display. Additionally, how multiple trace marker values are stacked can be adjusted.

To adjust the format or position of displayed marker values:

1. From the menu bar navigate to **Markers->Marker Functions**.
2. Click on the **Annotation [Options]** function button.
3. Click on the **Align** function button and select from the OFF, Vertical, or Horizontal options.
 - **OFF** will disable any vertical or horizontal stacking of trace annotations on screen. This is best applied when only one trace is active.
 - **Vertical** will display the annotated marker values for all active traces top to bottom.
 - **Horizontal** will display the annotated marker values for all active traces left to right.
4. Click **Data X Position** function button and enter the X axis percentage (0 ~ 100) to set the horizontal display position. The greater the value, the further to the right in the channel display the marker text will be moved.
5. Click the **Data Y Position** function button and enter the Y axis percentage (0 ~ 100) to set the vertical display position. The greater the value, the further to the bottom in the channel display the marker text will be moved.
6. Click on the **Font Size** function button to select from the different font sizes available.

NOTE

When multiple traces are present in a window, the marker position is indicated within the selected trace window only when the first trace is activated.

Limit Test

The use of limit testing allows an operator to apply immediate measurement evaluation with on-screen visualization to be set for each trace as well as a pass / fail status of the limit test result.

Pass / Fail status is determined by how a limit is defined in the limit table. Multiple limit entries can be added to the table as needed and are categorized by type, inspection frequency range, and the levels against which the limit test is to be judged. The limit table is as follows:

Figure 73 Limit Table

	Type	Stimulus Start	Stimulus Stop	Response Start	Response Stop
1	MIN	1.5GHZ	4.85GHZ	-40dB	-10dB
2	OFF	500kHz	6.5GHZ	-20dB	-34dB
3	OFF	500kHz	6.5GHZ	0dB	0dB
4	OFF	500kHz	6.5GHZ	0dB	0dB
5	OFF	500kHz	6.5GHZ	0dB	0dB

Limit table attributes and parameters definition:

Field Parameter	Description
Type	<p>OFF: Limit test is not enabled.</p> <p>MIN: Specifies the segment where the minimum values are located, and all measurements are to be greater than.</p> <p>MAX: Specifies the segment where the maximum values are located, and all measurements are to be less than.</p> <p>SINGLE: Specifies a single point at which the minimum and maximum value is located.</p>
Stimulus Start	Specifies the starting point of the limit line stimulus value.
Stimulus Stop	Specifies the end point of the limit line stimulus value.
Response Start	Specifies the response limit level for the stimulus start point of the limit line.
Response Stop	Specifies the response limit level for the stimulus stop point of the limit line.

NOTE

During a limit test in progress, any measurement points that do not meet the specified limits will be highlighted in red on the screen. The result of the test, whether it is a PASS or FAIL, will be displayed based on the limit lines, as depicted in [Figure 74 on page 65](#)

Figure 74 Limit test schematic



Limit Table Editing

The general process for limit table editing, including add, delete, modify, clear, save, restore and other operations are defined as follows.

To edit the limit table entries:

1. Choose the trace holding the marker of interest. Select the trace either by clicking the desired trace in the display area, or by using the 'Next Trace' or 'Previous Trace' menu options.
2. From the menu bard navigate to **Analysis->Limit Test** then click the **Edit Limit Line** function button as shown in [Figure 75](#).

Figure 75 Limit Table Editing

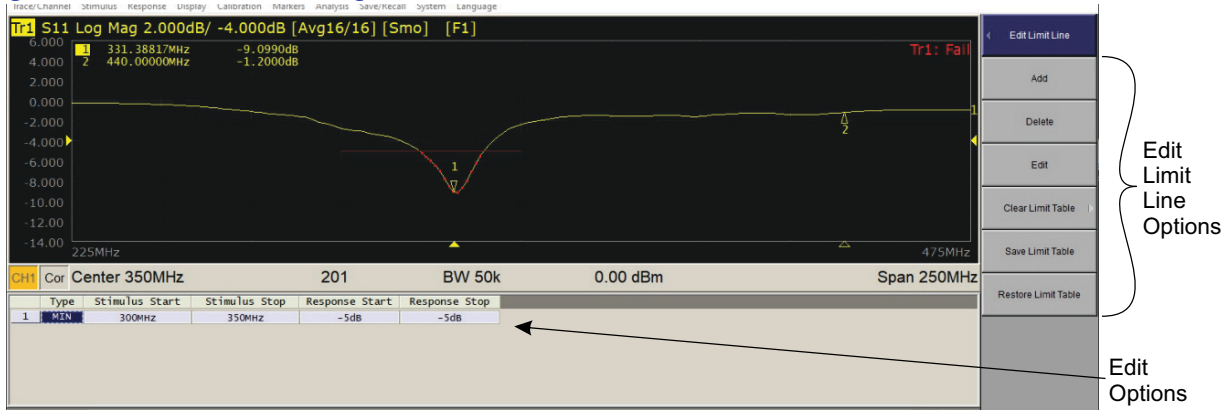

3. The operations of the function buttons applicable to the limit line table are as follows:

Function Button	Description
Delete	Delete the limit table where the cursor is located
Add	Add a row at the end of the limit table
Edit	Enter the limit table edit status
Clear Limit Table	Empty the entire limit table
Save Limit Table	Save the limit table as a file. Save the limit table as a file, extension: *. Lim, you can call it at any time on the screen and use it. You can use this text editor to open and edit.
Restore Limit Table	Restores the limit table from the file

- Click the **Add** button to add a limit entry item to the table.
- Click on the **Type** cell to select the type of limit to be applied. For example, **MAX**.
- Click on the **Start Stimulus** cell and enter the stimulus frequency at which the limit test will set its start point. Note that if the Type is set to **Single**, the Stimulus Start and Stimulus Stop values will be the same.
- Click on the **Stop Stimulus** cell and enter the stimulus frequency at which the limit test will set its stop point. Note that if the Type is set to **Single**, the Stimulus Start and Stimulus Stop values will be the same.
- Click on the **Response Start** cell and enter the level at which the Start Stimulus will apply a limit.
- Click on the **Response Stop** cell and enter the level at which the Stop Stimulus will apply a limit.
- To save the limit table setup, click on the **Save Limit Table** function button, then use the Save dialog set the name of the *.lim file and location on the PC where it will reside.
- To remove the limit table and all of its settings, click on the **Clear Limit Table** function button then click the OK button to confirm the choice.
- To recall a saved limit table from memory, click on the **Restore Limit Table** function button, then use the Open dialog to navigate to the saved limit file that is to be restored as a limit table.

Limit Line Offset

The limit line can be adjusted by adding a specific offset to the limit value.

To adjust the limit line:

1. From the menu bar navigate to **Analysis->Limit Test** then click the **Limit Line Offsets** function button.
2. Click **Analysis** and **Limit Test** then **Limit line Offset** function button.
3. Click the **Stimulus Offset** to input the desired value.
4. To apply a response offset, either:
 - Click on **Response Offset** to input the desired value,
 - Or click **Marker-> Response Ofs.** to add the amplitude offset equal to the search value of the job marker.

The meaning of each parameter is as follows:

Parameter	Description
Stimulus Offset	Add a certain offset to the stimulus value for the entire segment in the limit table.(Excitation Offset)
Response Offset	Add a certain offset to the response value of the entire segment in the limit table.(Amplitude offset)
Marker-> Response Ofs.	Adds an amplitude offset equal to the search value of the work marker. The current setting value of the amplitude offset can be confirmed by pressing Amplitude Offset. (Mark amplitude offset)

Figure 76 Limit Line Offset - Excitation Offset / Response Offset

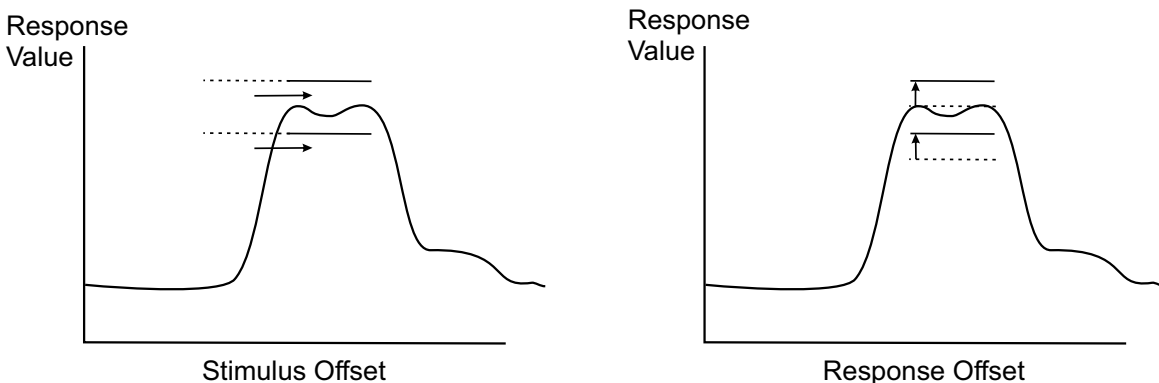

Turn ON / OFF Limit Test

The limit test can be enabled for when it is needed or disabled when it is not. Any settings applied as defined in the steps above will be preserved while in the OFF state.

Additionally, on-screen notifications can be enabled to help an operator identify failing limit test conditions.

To toggle the state of the limit test:

1. From the menu bar navigate to **Analysis->Limit Test**.
2. Click **Limit Test** function button to turn the limit test ON or OFF. When its state is set to ON, the limit conditions defined in the limit table will be evaluated and the result of the test will be shown in the upper right corner of the trace display area. When its state is set to OFF then limit test is deactivated.
3. Click the **Limit Line** function button to turn the limit lines ON or OFF. When its state is set to ON, the limit conditions defined in the limit table (lines and/or points) will be shown in the display; when its state is set to OFF the limit conditions will be hidden.
4. Click the **Fail Sign** button to turn the feature ON or OFF. When the status is set to ON, a failing limit test will cause a large red **Fail** text notification to appear in the center of the trace display area; a passing limit test will cause a large green **Pass** text notification to appear. When the status is set to OFF then it will hide the notification.

Ripple Test

The trace ripple value is the difference between the maximum and minimum stimulus response in the defined trace frequency band. The ripple test will evaluate the trace data against limits defined in the ripple limit table to determine whether or not it meets expectations. Up to 12 bands can be specified for testing, with each band being evaluated separately.

If no measurement point on the trace exceeds the ripple value specified by the ripple limit for any band, the ripple test will be considered a **Pass**. Otherwise, if any measurement point exceeds the specified ripple limit, the test will be considered a **Fail**. Measurements that fall outside the range of excitation limits will also be marked as **Fail**. In both cases, the corresponding measurement points will be highlighted in red on the screen. The overall test results for the traces will be displayed at the top right corner of the graph.

The test result for each trace will be displayed as "Ripl n: Pass" (ripple n: pass) or "Ripl n: Fail" (ripple n: fail), where "n" indicates the trace number. If the test result display for ripple values is enabled, the measured value for each band will be displayed as "Bn: <measurement value>", where "n" is the band number, as shown in [Figure 77](#).

Figure 77 Ripple Test Results



Ripple Limit Table Editing

The general process for ripple limit table editing, including add, delete, modify, clear, save, restore and other operations are defined as follows.

To edit the ripple limit table entries:

1. Choose the trace holding the marker of interest. Select the trace either by clicking the desired trace in the display area, or by using the 'Next Trace' or 'Previous Trace' menu options.
2. From the menu bar navigate to **Analysis->Ripple Limit** then click the **Ripple Value Band** function button and use the data entry bar to enter the band number (1 to 12).
3. Click the **Edit Ripple Limit** function button to reveal table editing options. The operations of the function buttons applicable to the ripple limit table are as follows:

Function button	Description
Delete	Remove the ripple limit table where the cursor is located.
Add	Add a ripple limit table.
Edit	Enter the ripple limit table to edit the state.
Clear Ripple Limit Table	Empty the entire ripple limit table.
Save Ripple Limit Table	Save the ripple limit table into a file. Save the limit table as a file, extension:*.Rlm, you can recall it at any time on the screen and use it. You can use this text editor to open and edit.
Restore Ripple Limit Table	Restore the ripple limit table from the file.

- Click the **Add** button to add a limit entry item to the table.
- Click on the **Type** cell to select the type of limit to be applied. For example, "ON".
- Click on the **Stimulus Start** cell and enter the stimulus frequency at which the ripple test will set its start point.
- Click on the **Stimulus Stop** cell and enter the stimulus frequency at which the ripple test will set its stop point.
- Click on the **Ripple Limit** cell and enter the ripple magnitude that the test will use for evaluation.
- To save the ripple limit table setup, click on the **Save Ripple Limit Table** function button, then use the Save dialog set the name of the *.rlm file and location on the PC where it will reside.
- To remove the ripple limit table and all its settings, click on the **Clear Ripple Limit Table** function button then click the **OK** button to confirm the choice.
- To recall a saved ripple limit table from memory, click on the **Restore Ripple Limit Table** function button, then use the Open dialog to navigate to the saved limit file that is to be restored as a ripple limit table.

Figure 78 Ripple Limit Table

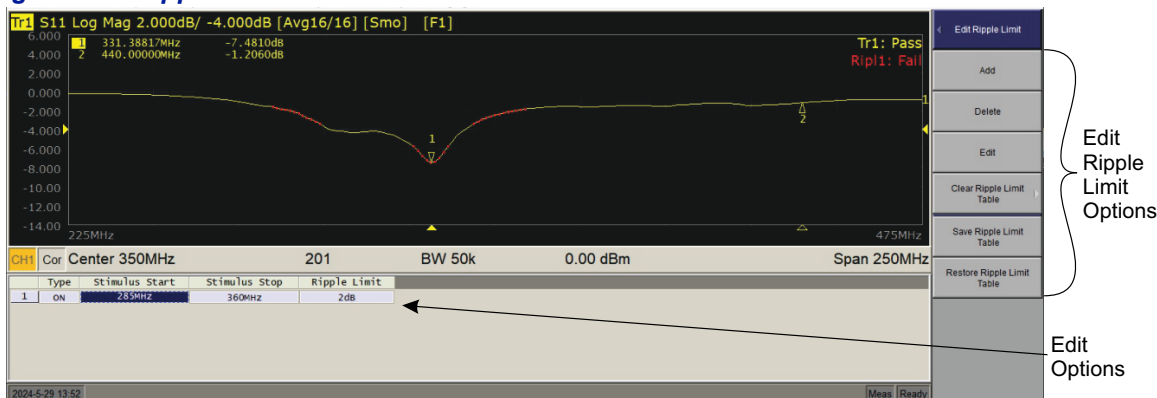

Turn ON / OFF the Ripple Limit Test

Ripple Test: The function buttons are described in the following table:

Function button	Description
Ripple Test	Set the ripple test ON / OFF
Ripple Limit	Set the ripple limit line to show or hide on screen.
Ripple Value	OFF: Turns off the display of test result values Absolute: Absolute value (the difference between the maximum and minimum values in the band) Margin: Margin (the difference between the absolute value of the ripple and the fluctuation limit)
Ripple Value Band	Select the band to display its ripple value (1 ~ 12)
Edit Ripple Limit	Open the fluctuation limit table to edit the fluctuation limit. To use the ripple test function, you must first define the ripple limit.
Fail Sign	ON: Displays the channel test result. OFF: Channel test results are not displayed.

To toggle the state of the ripple limit test:

1. From the menu bar navigate to **Analysis->Ripple Limit**.
2. Click **Ripple Test** function button to turn the ripple test ON or OFF. When its state is set to ON, the ripple limit conditions defined in the limit table will be evaluated and the result of the test will be shown in the upper right corner of the trace display area. When its state is set to OFF then limit test is deactivated.
3. Click the **Ripple Limit** function button to turn the ripple limit lines ON or OFF. When its state is set to ON, the ripple limit conditions defined in the limit table will be shown in the display; when its state is set to OFF the ripple limit conditions will be hidden.
4. Click the **Ripple Value** function button to select the display format of the fluctuation value. When selected OFF then test result will not show the ripple value. When **Absolute** is selected then test result shows the absolute value of the ripple. When **Margin** is selected then test result shows margin value of ripple.
5. Click the **Fail Sign** button to turn the feature ON or OFF. When the status is set to ON, a failing ripple limit test will cause a large red **FAIL** text notification to appear in the center of the trace display area. When the status is set to OFF then it will hide the notification.

Time Domain Analysis

The time domain analysis includes the following functions for determining the position and size of the mismatch.

1. Converts the measured data to the time domain (conversion function).
2. Delete unnecessary measurement data in the time domain (gating function).

By using this conversion function, frequency domain measurement results can be converted into time domain measurement data to perform the necessary analysis.

To configure time domain analysis:

1. Choose the trace holding the marker of interest. Select the trace either by clicking the desired trace in the display area, or by using the 'Next Trace' or 'Previous Trace' menu options.
2. From the menu bar navigate to **Analysis->Time Domain** then click the **Time Domain** function button to turn the limit test ON or OFF.
3. To set the Strobe Range, click **Start** to set the start time, **Stop** to set the stop time, **Center** to set the time middle value and **Span** to set the time interval value.
4. To set the Strobe Type, click the **Type** function button and select the function button that best matches the gating type.

Function Button	Description
Bandpass	For simulating the response of the bandpass network to the impulse
Lowpass Step	For simulating the response of the lowpass network to the unit step function
Lowpass Impulse	For simulating the response of the lowpass network to the impulse

5. To set the window shape: Click the **Window** function button then select the following function button.

Function Button	Description
Maximum	β maximum
Normal	β normal
Minimum	β minimum
Impulse Width	Impulse width setting
Kiser Beta	Kiser Beta β

Time Domain Gating Function

This function is used to remove unwanted response data from time domain measurements by mathematical operations. This function is used to measure the spurious effects of the frequency response when the fixture is measured, provided that the useful signal and the spurious signal can be separated in the time domain.

The measurement flow is shown in the following table and the following figure:

Measurement Steps and Items	Description
Frequency Domain Measurement	Measure in the frequency domain.
Change to the time domain	The transform function is enabled and the measured data is converted into data in the time domain.
Set the gate	The following settings are made for gating: gated type, gated shape, gated range.
Change back to frequency domain	The conversion function is disabled and the frequency domain response corresponding to the data selected using the gating is displayed.

Figure 79 Time domain gating measurement flow diagram

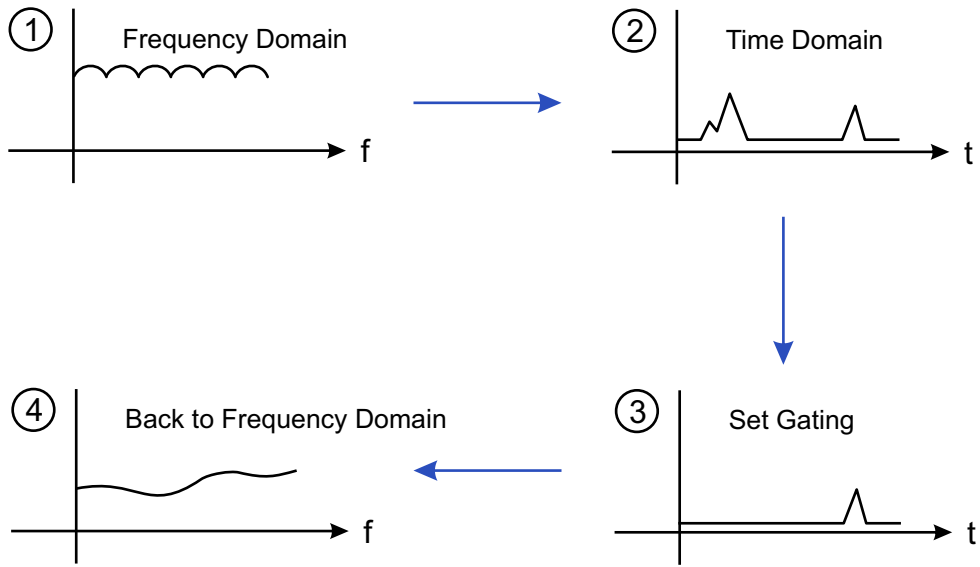

Gating Type

The gating type can be set to either of the following options.

Gating Type	Description
Bandpass	Removes the response outside the threshold range
Notch	Remove the threshold within the response

To set the gating type:

1. From the menu bar navigate to **Analysis->Gating**.
2. Click the **Type** function button to toggle between the Bandpass and Notch options.

Gating Shape

The gating shape is similar to a bandpass filter with a number of parameters representing the shape. The following figure illustrates the definition of gated shape parameters.

Figure 80 Time-domain gating measurement

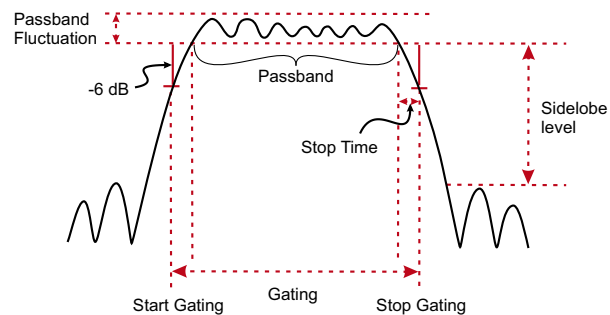

The gating shape parameters are described in the following table:

Gated Shape	Sidelobe Level	Gated resolution (minimum gated span)
Minimum	- 48 dB	2.8/ Frequency span
Normal	- 68 dB	5.6/ Frequency span
Wide	- 57 dB	8.8/ Frequency span
Maximum	- 70 dB	25.4/ Frequency span

To set the gating shape:

1. From the menu bar navigate to **Analysis->Gating**.
2. Click the **Shape** function button to select gating shapes described in above table.

Gating Range

Set the gate range by specifying the gating start and end time or by specifying the center time and time span, as shown in the above table.

To set the gating range:

1. From the menu bar navigate to **Analysis->Gating**.
2. Click the **Start** or **Stop** button to set the start and stop time.
3. Click the **Center** or **Span** function button to set the gating center time or gating time span.

Start the Gating Function

The time domain gating function only works in linear frequency sweep mode.

To start the gating function:

1. From the menu bar navigate to **Analysis->Gating**.
2. Click the **Gating** function button to toggle between ON (enabling the gating function) and OFF (disabling the gating function).

Saving Data/Settings

Data Retention Category

The different categories for preserving setup and data information are listed in the following table.

Data retention category	Description
State	Save the settings of the instrument and the saved settings can be recalled.
State & Cal	Save the instrument settings and calibration data to the instrument which can be recalled. At the same time calibration data is also transferred to the instrument which can be used to recall the measurement error correction.
State & Trace	Save the instrument settings and trace (error correction data array and error correction memory array), the saved data will be transferred to the instrument, you can reproduce the state of preservation, at the same time, will also recall the trace and display to the screen.
All	Save the instrument settings, calibrate the data and trace then save the data to the instrument to reproduce the status of the save and also recall the calibration data and trace.

Up to ten different save states can be defined for immediate access upon button click in the user interface, and additional states beyond these can be saved to disk for recall as well.

The Auto Recall setting allows for defining instrument settings that will automatically be applied when the instrument software is started.

Save State

To save the instrument settings:

1. On the menu bar, click **Save/Recall**. See [Figure 81 on page 75](#).
2. Click **Save Type**, choose the save category type. (To understand options, see ["Data Retention Category" on page 74](#).)
3. On the menu bar, click **Save/Recall**.
4. Click **Save State**
 - Choose from one of the following options:
 - Click one of the provided state recall buttons: State 01 through State 10. For a more descriptive state name, provide the text using the data entry bar then click on the **Enter** button. Once a state has been preserved, a "•" appears next to the button text. See [Figure 81](#).
 - Click on the **Auto Recall** button to set the instrument state as the default that will be applied when the software is started. Once an Auto Recall file is created, a "•" appears next to the "Auto Recall" text on the button.
 - Click on **State file** to open a Save dialog where the file name and location can be defined.

Figure 81 Save State

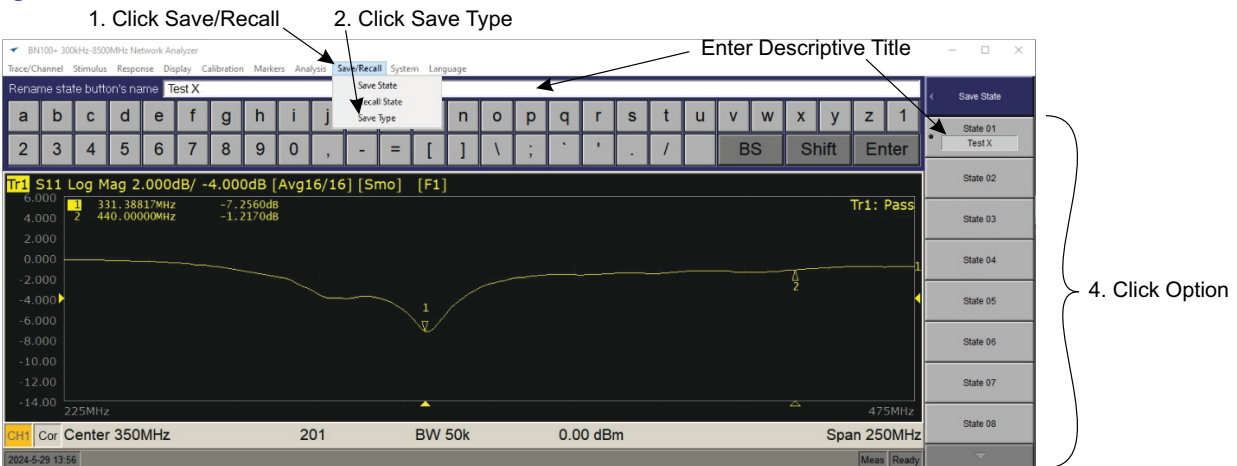

Save Channel

The instrument allows you to individually save / recall the instrument state of each channel. With this function the instrument state of the working channel can be saved separately to one of the four registers (A to D) and the instrument state can be recalled from the register and restored to the state of the current working channel.

Since this function is used to call the instrument state of each channel from the different channels used to save the instrument state, this function is useful for copying the instrument state between channels.

NOTE

Unlike the state of the entire instrument, the state of each channel is saved to the volatile memory rather than being saved to the file so that the state is lost if the power is turned off.

To save the channel state:

1. Choose the channel you wish to save. Press "Next Channel" or "Previous Channel" to select the desired channel to save its state.
2. Click **Save/Recall** on the function panel. Click on the purple button at the top of the options presented at the right-hand side of the screen until reaching **Main Menu**, then select **Save/Recall**.
3. Click the **Save Channel** function button.
4. Click one of the function button options (**State A** through **State D**) to save the instrument state of the working channel to the specified register. Once a channel state is saved, a "•" appears next to the button text.

Save Trace Data

The work trace data on the working channel can be saved to a CSV file (file extension * .csv) and the data can be loaded into the PC application for further processing.

To save the trace data:

1. Choose the channel or trace you wish to save. Press "Next Channel" or "Previous Channel" and "Next Trace" or "Previous Trace" to select the desired channel or trace. See [Figure 82](#).
2. Click **Save/Recall** option on function panel.
3. Click **Save Trace Data** option. A Save As dialog box will open.
4. Enter the file name.
5. Click **Save**.

Figure 82 Save Trace Data

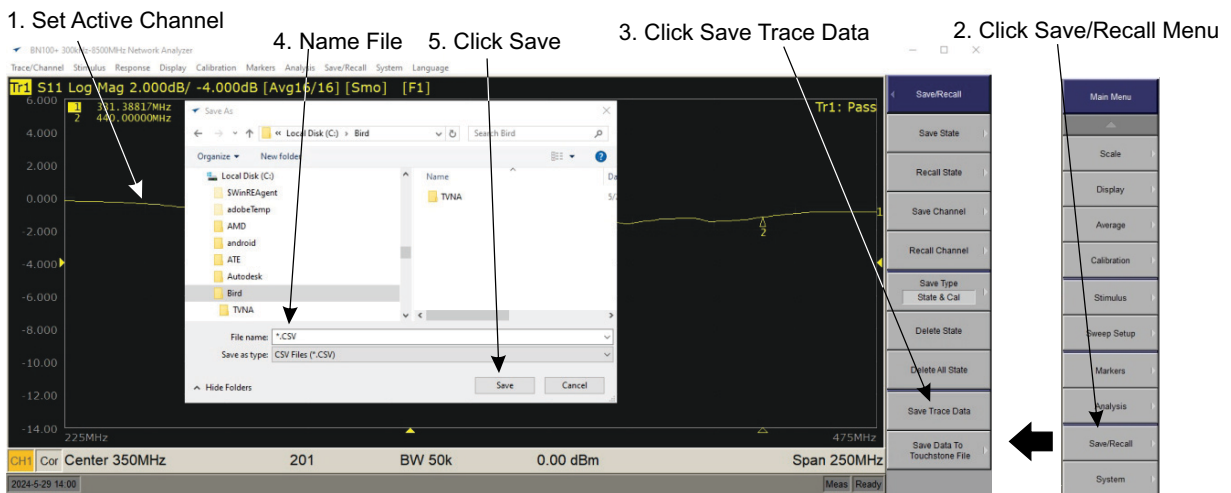

Save Data Touchstone

The data can be saved in "Real-Imaginary", "linear-angle-angle", or "logarithmic-angle" format. The file types are "*.s1p" and "*.s2p". The file type indicates the number of ports that output the data structure to the Touchstone file.

To save data to a Touchstone file:

1. Choose the channel or trace you wish to save. Click display to select desired channel or trace. See [Figure 83](#).
2. Click **Save/Recall** option on function panel.
3. Click **Save Data To Touchstone File**.
4. Click **Type** option to select the file type. Click the function button according to the port configuration that the Touchstone file should account for:
1-Port (s1p), 2-Port (s2p), 3-Port (s3p), or 4-Port (s4p).
5. Click the **Select Port** function button to identify which specific port(s) to account for in the saving process.
6. Click the **Format** function button to select the file format as shown in the following table:

File Format	Description
Real-Imaginary	Select the "real-imaginary" data format
Magnitude-Angle	Select the "Linear Amplitude - Angle" data format
dB-Angle	Select the "logarithmic amplitude - angle" data format

7. Click the **Save File** button to open the Save As dialog box.
8. Type a file name
9. Click **Save**.

Figure 83 Save The Data to TouchStone

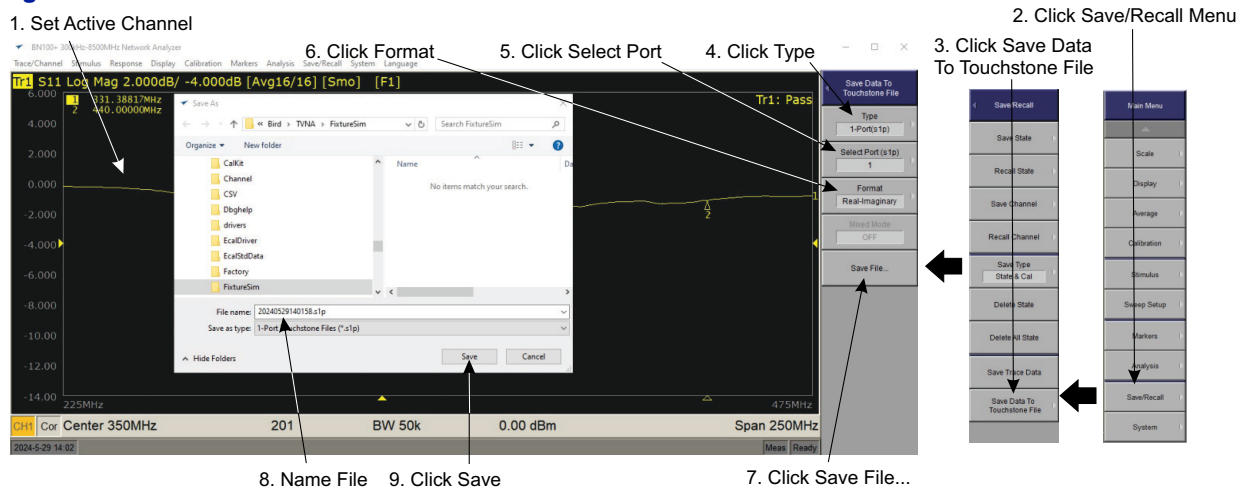

Recall Saved Data

Recall Saved State

To recall a saved state:

1. Click **Save/Recall** on the function panel. See [Figure 84](#).
2. Click **Recall State**.
3. Choose from one of the following options:
 - Click one of the provided state recall buttons: **State 01** through **State 10**. Note that only buttons that have a saved state associated with them will be enabled. See the figure below for illustration.
 - Click on the **Auto Recall** button to recall the state that is behind this function.
 - Click on **State file** to open an Open dialog where the file name and location can be selected. Valid files will use the ".sta" file extension.

Figure 84 Recall Saved State

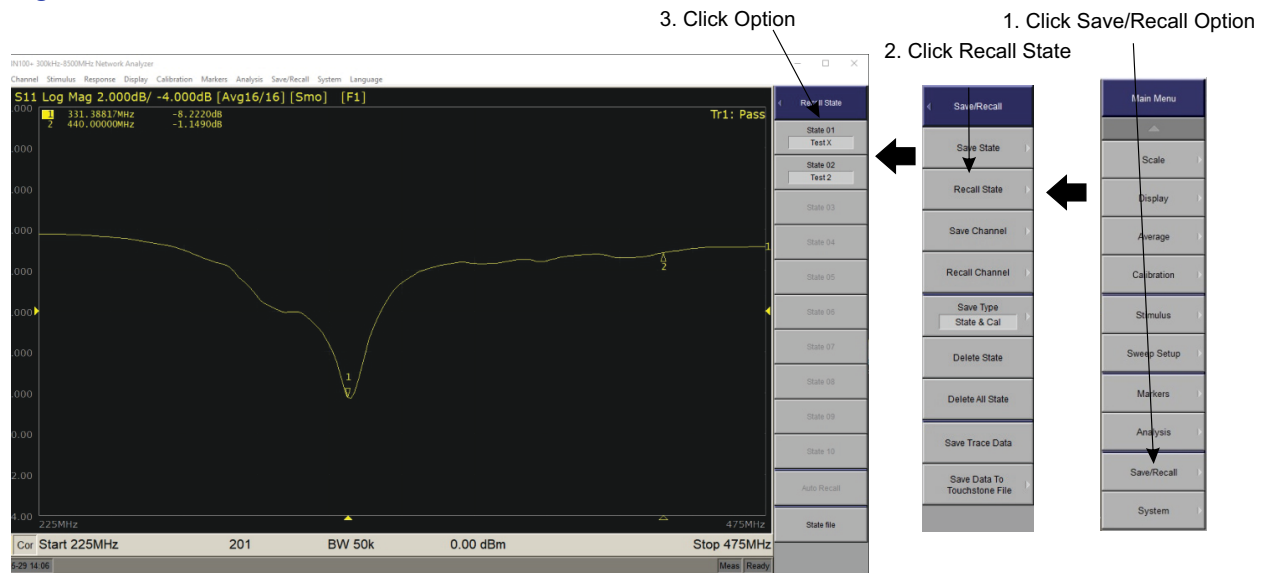

Recall Saved Channel

As noted above, the state of one channel can be saved and recalled (copied) to another channel.

To recall a channel state:

1. Choose the channel you wish to save. Press "Next Channel" or "Previous Channel" to select the desired channel.
2. Click **Save/Recall** on the function panel. Click on the purple button at the top of the options presented at the right-hand side of the screen until reaching 'Main Menu', then select **Save/Recall**.
3. Click the **Recall Channel** function button.
4. Click one of the function button options (**State A** through **State D**) to recall the instrument state to the working channel from specified register. Note that only buttons that have a saved channel state associated with them will be enabled. See [Figure 85](#).

Figure 85 Channel Recovery

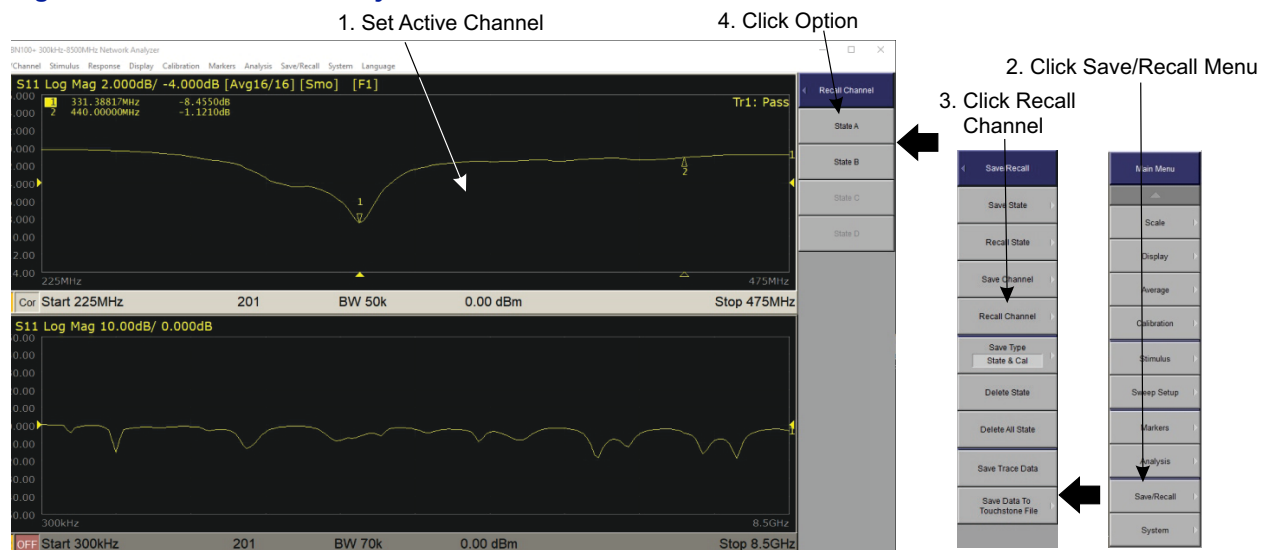

Delete State

In the event that the operator wishes to free up the saved states, existing state files can be deleted. The process of deleting the Auto Recall state is the same. Once a saved state file has been deleted, the associated Save State button will no longer show the "•" or optional name. Likewise, the associated Recall State button associated with the state file will become disabled and no longer show the optional name.

To delete a saved state:

1. Click **Save/Recall** on the function panel. Click on the purple button at the top of the options presented at the right-hand side of the screen until reaching 'Main Menu', then select **Save/Recall**.
2. Click the **Delete State** function button to open an Open dialog where the file name and location can be selected. "State1.sta" through "State10.sta" may be available along with "Auto.sta" and any other custom state files that have been saved with the "*.sta" extension.
3. After selecting a file, click the **Open** button. This will delete the file from disk.

Figure 86 Delete State

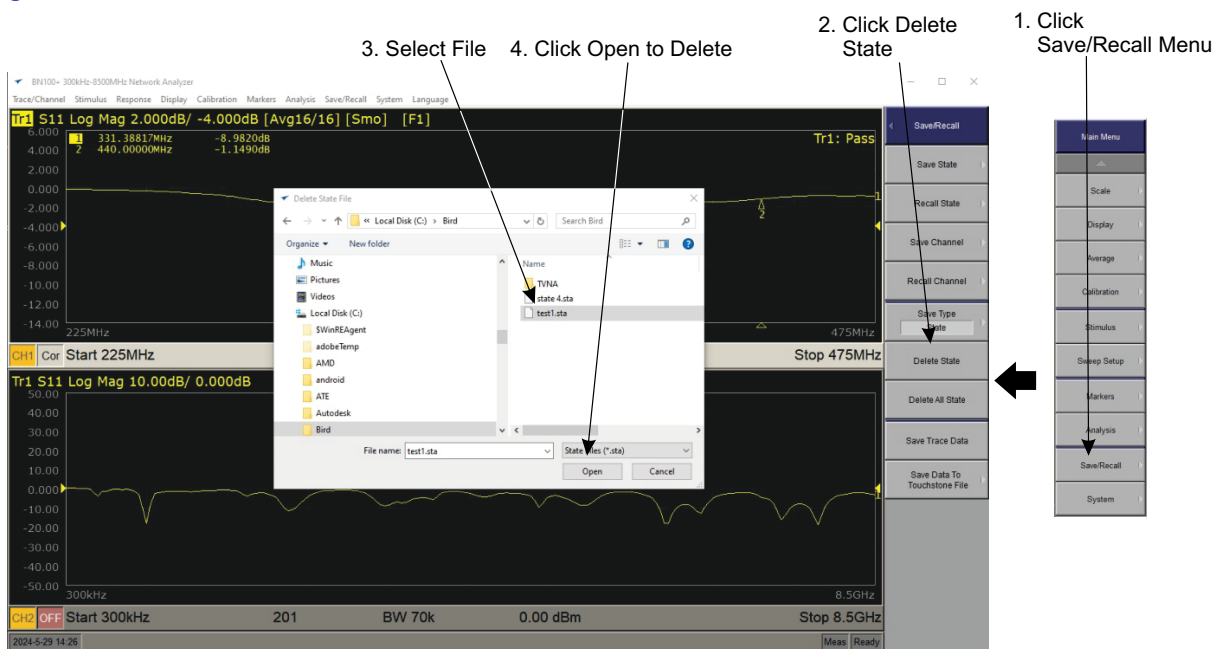

Delete All States

It may be in the operator's interest to clear any and all saved states from the system. Deleting all states will remove all save states associated with the State 01 through State 10 function buttons, but also the Auto Recall and any custom named state files found in the default location of C:\Bird\TVNA\State.

To delete all state files:

1. Click **Save/Recall** on the function panel. Click on the purple button at the top of the options presented at the right-hand side of the screen until reaching 'Main Menu', then select **Save/Recall**.
2. Click on the **Delete All State** function button.
3. When presented with the Warning dialog, choose either **OK** to continue with the deletion process or **Cancel** to discontinue the action.

Expand the Dynamic Range

The dynamic range is the finite difference between the maximum input power level of the analyzer and the minimum measured power level (background noise). It is important to increase the dynamic range when evaluating a characteristic accompanied by a large change in amplitude (e.g., passband or stopband for a filter). The dynamic range can be increased by reducing the noise floor of the receiver.

There are two ways to reduce the receiver noise:

- Reduce IF Bandwidth
- Open the scan average

Reduce IF Bandwidth

Reducing the IF bandwidth of the receiver can reduce the impact of random noise on the measurement. Reducing the IF bandwidth to 1/10 of the original bandwidth reduces the bottom noise of the receiver by 10 dB.

To reduce IF bandwidth:

1. Select the desired channel or trace. Press "Next Channel" or "Previous Channel" and "Next Trace" or "Previous Trace".
2. Use the menu bar to navigate to **Response->Average**.
3. Click the **IF Bandwidth** function button to expose the data entry bar and change the value.

Open the Average Scan Average

The averaging process is conducted over several sweeps for each measurement point, presenting advantages akin to IF bandwidth narrowing. This approach enhances the signal-to-noise ratio and expands the dynamic range of measurements. The averaging of individual measurement points follows a specific formula, wherein the scan average minimizes the influence of random noise on measurements. This involves averaging data (vectors) for each point by considering the average of user-specified values across successive scans. The scanning average is mathematically represented by the following equation.

$$A_n = \frac{S_n}{F} + \left(1 - \frac{1}{F}\right) \times A_n - 1$$

Where:

A_n = Scan average calculation result when nth scan operation performed at the relevant point (vector).

S_n = Measured value obtained when nth scan operation is performed at the relevant point (vector)

F = Scan average factor (integer from 1 to 999)

To apply sweep averaging:

1. Select the desired channel or trace. Press "Next Channel" or "Previous Channel" and "Next Trace" or "Previous Trace".
2. Use the menu bar to navigate to **Response->Average**.
3. Click on the **Averaging** function button to toggle the averaging ON or OFF.
4. Click the **Avg Factor** function button to change the value of the scan average factor used for the averaging calculation. The default value is 16.

Reduce Trace Noise

Smoothing in the analyzer averages neighboring trace points using a moving window, with the window size as a percentage of total trace points. It doesn't extend measurement time or increase the dynamic range. Smoothing reduces noise bursts and is applied separately to each trace. For improved trace representation, mathematical smoothing calculates the moving average of nearby points.

The smooth aperture (percentage of scan span) defines the range of points to be included in the moving average calculation.

To apply trace smoothing:

1. Select the desired channel or trace. Press "Next Channel" or "Previous Channel" and "Next Trace" or "Previous Trace".
2. Use the menu bar to navigate to **Response->Average**.
3. Click the **Smoothing** function button to toggle smoothing ON or OFF.
4. Click the **Smo Aperture** function button to change the (%).

Improve the Accuracy of Phase Measurement

Electrical Delay

The electrical delay function can add or remove a lossless transmission line whose length varies with the receiver input. Use this function to increase the resolution of the phase measurement so that the linear phase offset can be measured.

To adjust the electrical delay:

1. Select the desired channel or trace. Press "Next Channel" or "Previous Channel" and "Next Trace" or "Previous Trace".
2. Use the menu bar to navigate to **Response->Scale**.
3. Click the **Electrical Delay** function button and use the data entry bar to change the value.

Phase Offset

The phase offset function may be used to add or subtract a predetermined value associated with the frequency of the incoming and outgoing traces. Use this function to simulate a phase shift that occurs after an event such as adding a cable.

To adjust the phase offset:

1. Select the desired channel or trace. Press "Next Channel" or "Previous Channel" and "Next Trace" or "Previous Trace".
2. Use the menu bar to navigate to **Response->Scale**.
3. Click the **Phase Offset** function button and use the data entry bar to change the value.

Increase the Measurement Speed

Closing the Update of Display Information

The operator may opt to save processing time and thereby increasing the measurement speed through disabling the display information update.

To disable the display updates:

1. Click **Display** on the function panel. Click on the purple button at the top of the options presented at the right-hand side of the screen until reaching 'Main Menu', then select **Display**.
2. Click the **Update** function button to toggle the update its status to OFF to halt the update of the display. Click again to toggle to ON and enable updates.

Offset Error Correction

After closing the error calibration, you can reduce the data processing time required during the measurement process thereby increasing the measurement speed.

To change the state of the measurement calibration data application:

1. Click **Calibration** on the function panel. Click on the purple button at the top of the options presented at the right-hand side of the screen until reaching 'Main Menu', then select **Calibration**.
2. Click the **Correction** function button to toggle its status to OFF. Click again to toggle to ON and enable corrections.

Segment

Overview

Segmentation is to define two or more bands (called segments) and then specify the number of points, IF bandwidth, power level, scan mode, scan delay and scan time for each segment. It performs a scan of all segments in sequence just as the scan was done in one scan operation.

By skipping the band that you do not need to measure, you can scan and measure only the parts you need and effectively increase the measurement speed. The best measurement conditions can be defined for each of the specified segments.

For example, to evaluate a bandpass filter with transmission characteristics ([Figure 87](#)), you can select the desired frequency band from A to G and determine the measurement conditions ([Table 16](#)). This allows them to be measured simultaneously in a single scan operation. As shown in [Figure 87](#) and [Table 16](#), set A, B, C, E, G segments.

Figure 87 Schematic diagram of segmented scanning

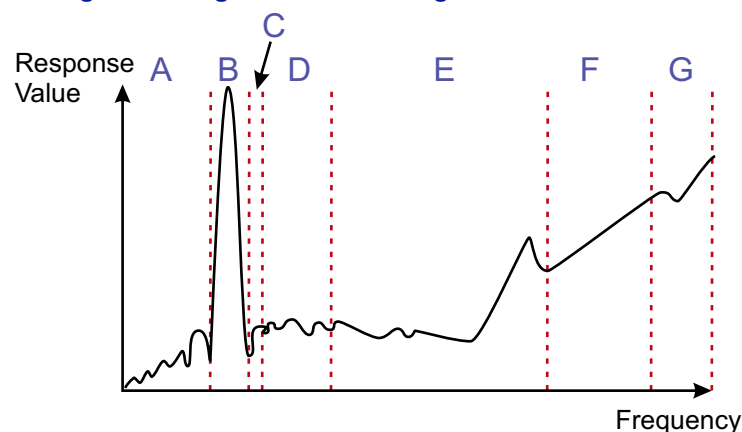

Table 16 Segmented Scanning

	Start Frequency	Termination Frequency	Points	IF Bandwidth	Power	Delay
A	440 MHz	915MHz	50	50kHz	0dBm	0s
B	915 MHz	980MHz	130	70kHz	0dBm	0s
C	980 MHz	1.035GHz	60	50kHz	0dBm	0s
D	1.035GHz	1.07GHz				
E	1.07GHz	2GHz	100	70kHz	0dBm	0s
F	2GHz	2.6GHz				
G	2.6GHz	3GHz	40	70kHz	0dBm	0s

Definition of Segmentation Tables

Some general guidelines for defining segments are as follows.

1. A segmented frequency band cannot overlap with another segmented frequency band. (The start frequency of the segment must be higher than the termination frequency of its previous segment).
2. The start frequency of the first segment in the table must be greater than or equal to the starting frequency of the instrument frequency range. Likewise, the end frequency of the last segment must be less than or equal to the end frequency of the instrument frequency range.
3. The minimum number of points for a segment is 2.
4. The maximum number of points for a segment is limited by the maximum number of points available for the network analyzer model minus the number of points associated with other defined segments.
5. Additional data items can be set for each segment in addition to the defaults of scan range (start and stop stimulus frequencies) and points. These include:
 - a. IF bandwidth (IFBW)
 - b. Power level (Power)
 - c. Scan delay (Delay)

Data Item	Description
Start	Sets the start value of the scan range
Stop	Sets the end value of the scan range
Points	Set the number of scanning points
IFBW	Set the IF bandwidth
POWER	Set the scan function
Delay	Set the scan delay

To define segments:

1. Select the desired channel or trace. Press "Next Channel" or "Previous Channel" and "Next Trace" or "Previous Trace".
2. Click **Sweep Setup** on the function panel. Click on the purple button at the top of the options presented at the right-hand side of the screen until reaching 'Main Menu', then select **Sweep Setup**.
3. Click the **Segment Table** function button to enter the table definition function menu. Use the additional function buttons to define the segments of interest. The actions of each function button are described in the following table:

Function Button	Description
Add	Add a row of data to the segment table
Delete	Delete the last row of data in the staging table

Function Button	Description
Edit	Enter the segment table item edit status
List IFBW	Turns on or off the IFBW data item
List Power	Turns the Power data item on or off
List Delay	Turns the Delay data item on or off

The table definition interface is shown in [Figure 88](#).

Figure 88 Segment Table definition interface



Execution of Segmented Scans

To enable execution of segmented scans:

1. Select the desired channel or trace. Press "Next Channel" or "Previous Channel" and "Next Trace" or "Previous Trace".
2. Click **Stimulus** on the menu bar.
3. Click the **Sweep Type** option.
4. Click **Segment** on the function panel.

Figure 89 Execution of Segment table

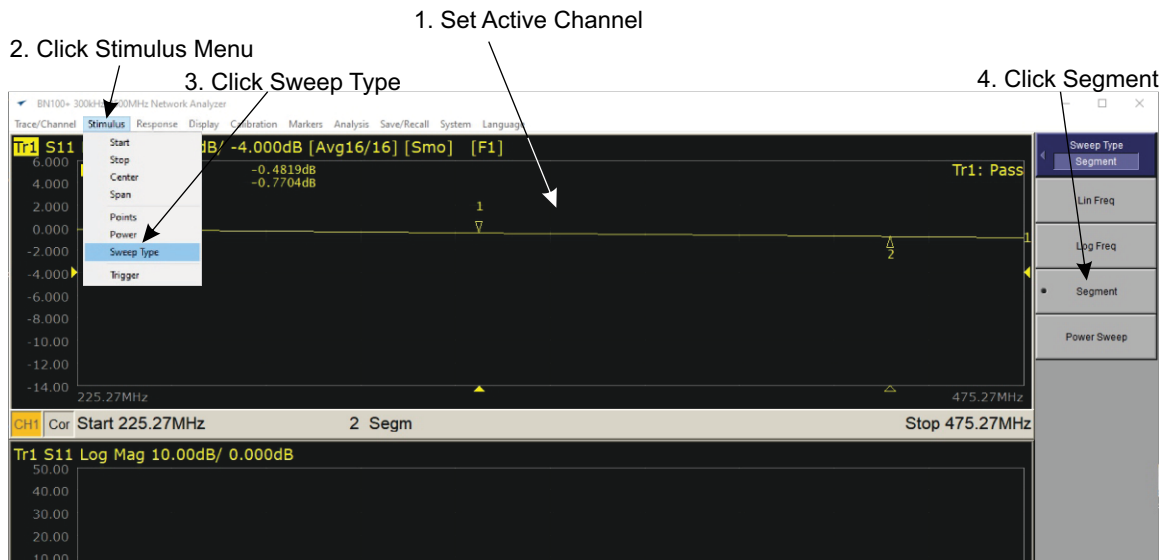

SYSTEM FUNCTIONS

The following procedures utilize operating system features.

Print Function

Printer Output Function

To print the analyzer display on paper:

1. Click **System** on the function panel.
2. Click **Print** button.
3. (Optional but recommended to save ink) Click the **Invert Image** function button to toggle between the normal print (OFF for black channel background) or reverse color print (ON for white channel background).
4. Click the **Print** button to pop-up printer settings window as shown in [Figure 90](#).
5. Press the **OK** button to start printing.

Figure 90 Printer Settings Window

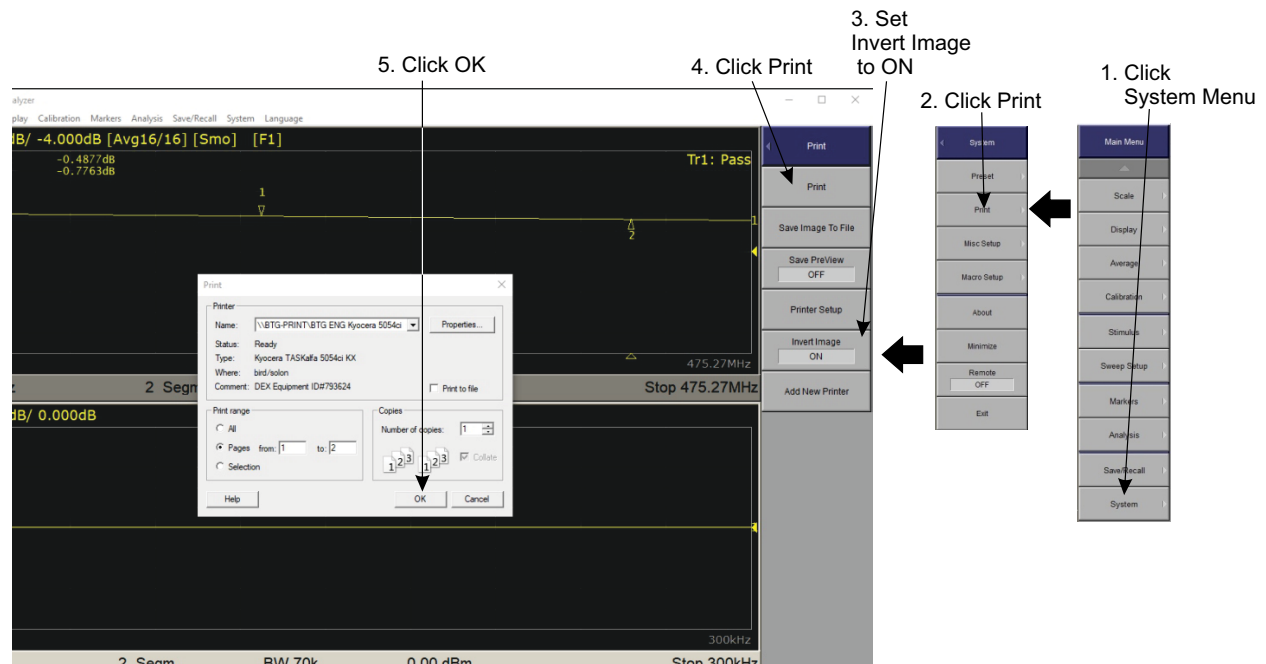

Save Image to File

To save a screenshot of the analyzer display:

1. Click **System** on the function panel.
2. Click **Print** button.
3. (Optional) Click the **Invert Image** function button to toggle between the normal print (OFF for black channel background) or reverse color print (ON for white channel background).
4. Click the **Save Image to File** button to pop-up file name input window as shown in [Figure 91](#).
5. Enter the file name.
6. Click **Save** button to save the image file.

Figure 91 File name input window

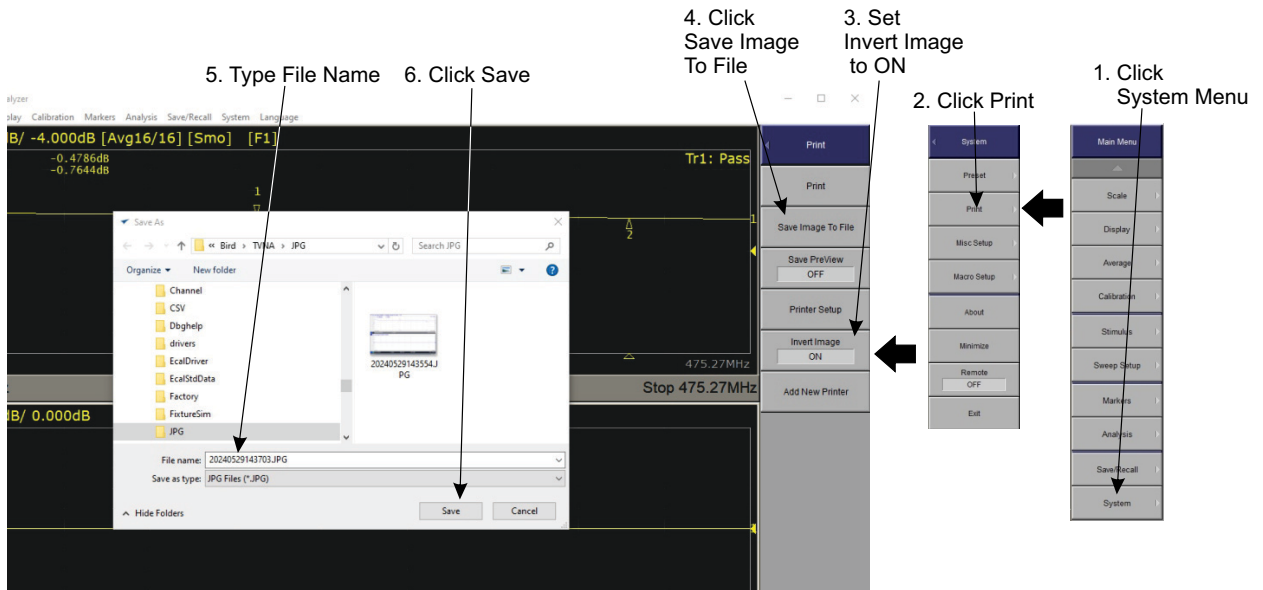

System Setting

Ref Source (BNA1000 VNA Only)

To modify the reference source:

1. Click **System** on the function panel. Click on the purple button at the top of the options presented at the right-hand side of the screen until reaching 'Main Menu', click on the down function button at the bottom of the column, then select **System**.
2. Click **Misc Setup** function button.
3. Click the **Ref Source** button. Select **External** for the external reference source or **Internal** for system inbuilt signal source.

Key Lock

You can lock (disable) the keyboard on the PC connected to the VNA. Use this function to prevent the measurement from being affected by accidental key presses.

To lock the front panel:

1. Click **System** on the function panel.
2. Click **Misc Setup** function button.
3. Click the **Key Lock** function button
4. Click the **Keyboard Lock** function button to disable the PC keyboard for the BVNA.

Figure 92 Keyboard Lock

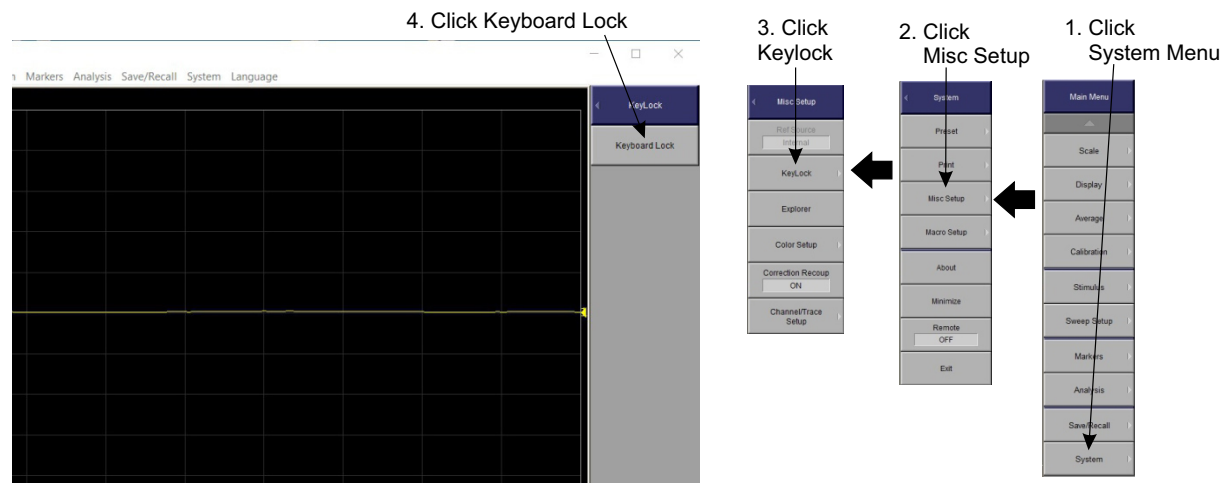

Explorer

To readily access files for achieving copy, paste, and other operations, a button is made available within the network analyzer software interface.

To open File Explorer from the analyzer interface:

1. Click **System** on the function panel. Click on the purple button at the top of the options presented at the right-hand side of the screen until reaching 'Main Menu', click on the down function button at the bottom of the column, then select **System**.
2. Click the **Misc Setup** function button.
3. Click the **Explorer** to open an explorer window interface.

Figure 93 Open Explorer Window

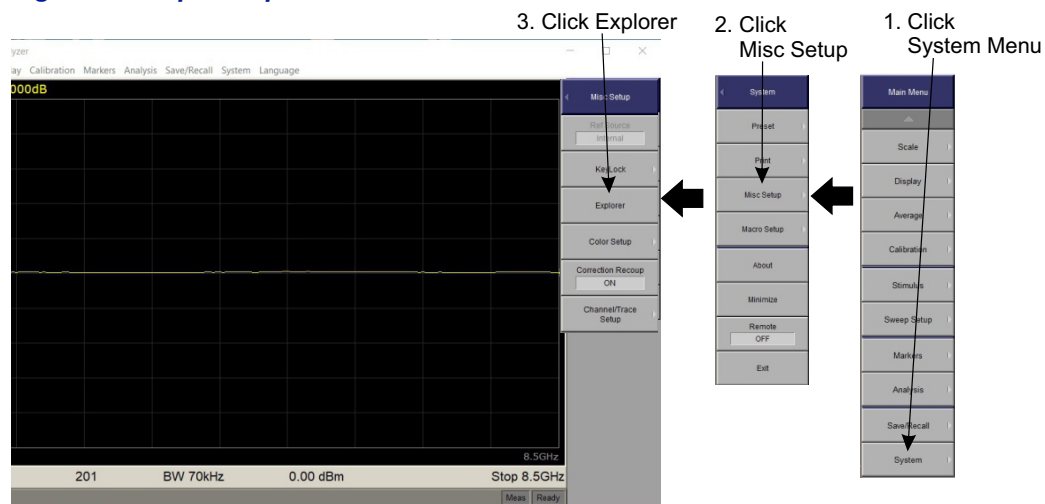

Color Setup

This function is used to set or customize the color of the different traces or memory traces.

To change the color of a trace:

1. Click **System** on the function panel. Click on the purple button at the top of the options presented at the right-hand side of the screen until reaching 'Main Menu', click on the down function button at the bottom of the column, then select **System**.
2. Click the **Misc Setup** function button.
3. Click the **Color Setup** function button.
4. Click the **Trace** or **Mem Trace** function button for the trace to be modified. Use of the up or down arrow buttons may be necessary to access the trace of interest. to select the color of the trace.
5. Click on the color option to be modified: **RED, GREEN** or **BLUE**.
6. Use the function buttons (numbered 0 through 5) to select the value applied to the color.

Figure 94 Trace Color Setup

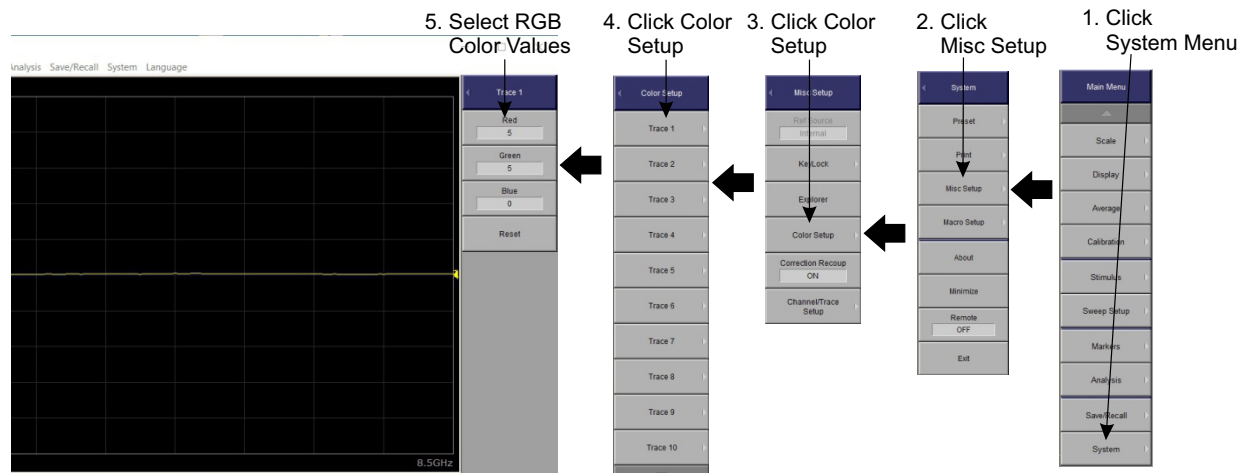

Preset

This function allows the instrument to return to the instrument default preset state.

To reset the Bird VNA to factory default settings:

1. Click on the **System** menu
2. Click the **Preset** option to display the function menu.
3. Click the **OK** function button to reset the Bird VNA to the factory default settings.

Figure 95 Preset Function Menu

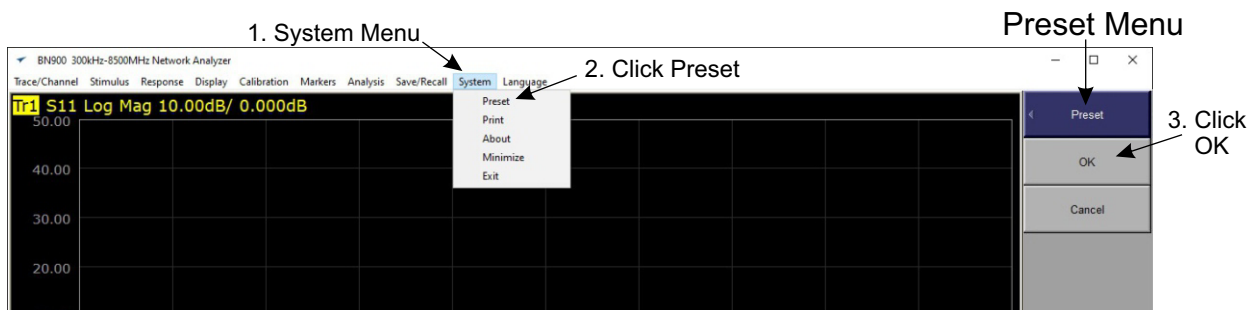

About

This option is used to get the description of the instrument model, vendor, software version number and other information.

To view the instrument information:

1. Click **System** on the function panel. Click on the purple button at the top of the options presented at the right-hand side of the screen until reaching 'Main Menu', click on the down function button at the bottom of the column, then select **System**.
2. Click the **About** function button to see the information.

Minimize

This function is used to minimize the screen display.

1. Click **System** on the function panel. Click on the purple button at the top of the options presented at the right-hand side of the screen until reaching 'Main Menu', click on the down function button at the bottom of the column, then select **System**.
2. Click the **Minimize** function to minimize the screen.

SET PARAMETERS AND RANGE

The following table summarizes the setup parameters and range, instrument, channel, or trace that they control.

Parameter	Controlled Range			Set Key
	Device	Channel	Trace	
Scanning range		✓		Start, Stop, Center, Span
Power, CW frequency		✓		"Sweep Setup">"Power"
Scan time / scan delay		✓		"Sweep Setup">"Sweep Time"/"Sweep Delay"
Points		✓		Sweep Setup >"Points"
Segmented scanning		✓		"Sweep Setup">"Sweep Type", "Edit Segment Table"/"Segment Display"
scanning method		✓		"Sweep Setup">"Sweep Mode"
Trigger source	✓			"Trigger">"Trigger Source"/"Restart"/"Trigger"
Trigger mode		✓		"Trigger" > "Hold"/"Hold AllChannels"/"Single"/ "Continuous" / "Continuous Disp Channels"
Measurement parameters			✓	Meas
Data Format			✓	Format
Scale, electrical delay, phase offset			✓	Scale
Storage traces and data calculations			✓	"Display">"Display"/"Data -> Mem"/"Data Math"
Window title		✓		"Display" >"Edit Title Labe" /"Title Label (ON/OFF)"
Display update on / off	✓			"Display" >"Update (ON/OFF)"
average		✓		"Avg">"Averaging Restart"/"Avg Factor" / "Averaging (ON/OFF)"
smooth			✓	"Avg" >"Smo Aperture"/"Smoothing (ON/OFF)"
IF bandwidth		✓		"Avg" >"IF Bandwidth"
calibration		✓		Cal
mark			✓	"Marker", "Marker Search", "Maker Fctn"
Fixture simulator		✓		"Analysis" >"Fixture Simulator"
Time Domain			✓	"Analysis">"Gating" /"Transform"
Parameter conversion			✓	"Analysis" >"Conversion"
Limit test			✓	"Analysis">"Limit Test"
Save and call data	✓			Save/Recall
Print / copy / buzzer / network settings /lock key /	✓			System
Preset	✓			Preset

Limited Warranty

All products manufactured by Seller are warranted to be free from defects in material and workmanship for a period of one (3) year unless otherwise specified from date of shipment and to conform to applicable specifications, drawings, blueprints and/or samples. Seller's sole obligation under these warranties shall be to issue credit, repair or replace any item or part thereof which is proved to be other than as warranted; no allowance shall be made for any labor charges of Buyer for replacement of parts, adjustment or repairs, or any other work, unless such charges are authorized in advance by Seller.

If Seller's products are claimed to be defective in material or workmanship or not to conform to specifications, drawings, blueprints and/or samples, Seller shall, upon prompt notice thereof, either examine the products where they are located or issue shipping instructions for return to Seller (transportation-charges prepaid by Buyer). In the event any of our products are proved to be other than as warranted, transportation costs (cheapest way) to and from Seller's plant, will be borne by Seller and reimbursement or credit will be made for amounts so expended by Buyer. Every such claim for breach of these warranties shall be deemed to be waived by Buyer unless made in writing within ten (10) days from the date of discovery of the defect.

The above warranties shall not extend to any products or parts thereof which have been subjected to any misuse or neglect, damaged by accident, rendered defective by reason of improper installation or by the performance of repairs or alterations outside of our plant, and shall not apply to any goods or parts thereof furnished by Buyer or acquired from others at Buyer's request and/or to Buyer's specifications. Routine (regularly required) calibration is not covered under this limited warranty. In addition, Seller's warranties do not extend to the failure of tubes, transistors, fuses and batteries, or to other equipment and parts manufactured by others except to the extent of the original manufacturer's warranty to Seller.

The obligations under the foregoing warranties are limited to the precise terms thereof. These warranties provide exclusive remedies, expressly in lieu of all other remedies including claims for special or consequential damages. SELLER NEITHER MAKES NOR ASSUMES ANY OTHER WARRANTY WHATSOEVER, WHETHER EXPRESS, STATUTORY, OR IMPLIED, INCLUDING WARRANTIES OF MERCHANTABILITY AND FITNESS, AND NO PERSON IS AUTHORIZED TO ASSUME FOR SELLER ANY OBLIGATION OR LIABILITY NOT STRICTLY IN ACCORDANCE WITH THE FOREGOIN.