



WATTCHER MONITOR/ALARM

MODEL 3170B

OPERATION MANUAL

Safety Precautions

The following are general safety precautions that are not necessarily related to any specific part or procedure, and do not necessarily appear elsewhere in this publication. These precautions must be thoroughly understood and apply to all phases of operation and maintenance.

WARNING
Keep Away From Live Circuits
Operating Personnel must at all times observe general safety precautions. Do not replace components or make adjustments to the inside of the test equipment with the high voltage supply turned on. To avoid casualties, always remove power.

WARNING
Shock Hazard
Do not attempt to remove the RF transmission line while RF power is present.

WARNING
Do Not Service Or Adjust Alone
Under no circumstances should any person reach into an enclosure for the purpose of service or adjustment of equipment except in the presence of someone who is capable of rendering aid.

WARNING
Safety Earth Ground
An uninterruptible earth safety ground must be supplied from the main power source to test instruments. Grounding one conductor of a two conductor power cable is not sufficient protection. Serious injury or death can occur if this grounding is not properly supplied.

WARNING
Resuscitation
Personnel working with or near high voltages should be familiar with modern methods of resuscitation.

WARNING
Remove Power
Observe general safety precautions. Do not open the instrument with the power on.

Safety Symbols

WARNING
Warning notes call attention to a procedure, which if not correctly performed could result in personal injury.

CAUTION
Caution notes call attention to a procedure, which if not correctly performed could result in damage to the instrument.

Note: *Calls attention to supplemental information.*

Warning Statements

The following safety warnings appear in the text where there is danger to operating and maintenance personnel and are repeated here for emphasis.

WARNING
Do not use electrically conductive tools for calibration when the front panel is removed. Damage to the unit and or the possibility of electrical shock exists.

See page 9.

WARNING
Become thoroughly familiar with modern methods of resuscitation before working near high voltage sources.

See page 13.

WARNING
Shock hazard. Always turn off AC power before removing any equipment panels.

See page 13.

WARNING
Disconnect this unit from AC power source before any disassembly for cleaning, repair or replacement procedures. The potential for electrical shock exists.

See pages 13 and 17.

WARNING
When using dry cleaning solvents, provide adequate ventilation and observe normal safety precautions. Many dry cleaning agents emit toxic fumes that may be harmful to your health if inhaled.

See page 13.

Caution Statements

The following equipment cautions appear in the text whenever the equipment is in danger of damage and are repeated here for emphasis.

CAUTION
Be sure the 115/230 voltage selector switch on the rear panel is set to the proper line voltage before AC power is applied.

See page 8.

CAUTION
Do not bend this contact finger when cleaning. The position of this contact is somewhat critical. If it is out too far the element will not enter the socket and if it is in too far, it will not make contact with the button on the element. For contact adjustments, refer to "[Adjusting the Element Wiper Contact](#)" on page 16.

See page 13.

CAUTION
If the element cannot be fully inserted into the socket, do not force it. You might damage the element wiper contact.

See page 16.

CAUTION
Be careful not to bend element wiper contact out too far as to interfere with insertion of the elements.

See page 16.

Safety Statements

USAGE

ANY USE OF THIS INSTRUMENT IN A MANNER NOT SPECIFIED BY THE MANUFACTURER MAY IMPAIR THE INSTRUMENT'S SAFETY PROTECTION.

USO

EL USO DE ESTE INSTRUMENTO DE MANERA NO ESPECIFICADA POR EL FABRICANTE, PUEDE ANULAR LA PROTECCIÓN DE SEGURIDAD DEL INSTRUMENTO.

BENUTZUNG

WIRD DAS GERÄT AUF ANDERE WEISE VERWENDET ALS VOM HERSTELLER BESCHRIEBEN, KANN DIE GERÄTESICHERHEIT BEEINTRÄCHTIGT WERDEN.

UTILISATION

TOUTE UTILISATION DE CET INSTRUMENT QUI N'EST PAS EXPLICITEMENT PRÉVUE PAR LE FABRICANT PEUT ENDOMMAGER LE DISPOSITIF DE PROTECTION DE L'INSTRUMENT.

IMPIEGO

QUALORA QUESTO STRUMENTO VENISSE UTILIZZATO IN MODO DIVERSO DA COME SPECIFICATO DAL PRODUTTORE LA PROIZIONE DI SICUREZZA POTREBBE VENIRNE COMPROMESSA.

SERVICE

SERVICING INSTRUCTIONS ARE FOR USE BY SERVICE - TRAINED PERSONNEL ONLY. TO AVOID DANGEROUS ELECTRIC SHOCK, DO NOT PERFORM ANY SERVICING UNLESS QUALIFIED TO DO SO.

SERVICIO

LAS INSTRUCCIONES DE SERVICIO SON PARA USO EXCLUSIVO DEL PERSONAL DE SERVICIO CAPACITADO. PARA EVITAR EL PELIGRO DE DESCARGAS ELÉCTRICAS, NO REALICE NINGÚN SERVICIO A MENOS QUE ESTÉ CAPACITADO PARA HACERLO.

WARTUNG

ANWEISUNGEN FÜR DIE WARTUNG DES GERÄTES GELTEN NUR FÜR GESCHULTES FACHPERSONAL.

ZUR VERMEIDUNG GEFÄHRLICHE, ELEKTRISCHE SCHOCKS, SIND WARTUNGSARBEITEN AUSSCHLIEßLICH VON QUALIFIZIERTEM SERVICEPERSONAL DURCHZUFÜHREN.

ENTRETIEN

L'EMPLOI DES INSTRUCTIONS D'ENTRETIEN DOIT ÊTRE RÉSERVÉ AU PERSONNEL FORMÉ AUX OPÉRATIONS D'ENTRETIEN. POUR PRÉVENIR UN CHOC ÉLECTRIQUE DANGEREUX, NE PAS EFFECTUER D'ENTRETIEN SI L'ON N'A PAS ÉTÉ QUALIFIÉ POUR CE FAIRE.

ASSISTENZA TECNICA

LE ISTRUZIONI RELATIVE ALL'ASSISTENZA SONO PREVISTE ESCLUSIVAMENTE PER IL PERSONALE OPPORTUNAMENTE ADDESTRATO. PER EVITARE PERICOLOSE SCOSSE ELETTRICHE NON EFFETTUARRE ALCUNA RIPARAZIONE A MENO CHE QUALIFICATI A FARLA.

About This Manual

This manual covers the operating and maintenance instructions for the following models:

3170B	3170B400
3171B	3171B020

Changes to this Manual

We have made every effort to ensure this manual is accurate. If you discover any errors, or if you have suggestions for improving this manual, please send your comments to our Solon, Ohio factory. This manual may be periodically updated. When inquiring about updates to this manual refer to the part number and revision on the title page.

Chapter Layout

Introduction — Describes the features, lists equipment supplied and optional equipment, and provides power-up instructions.

Theory of Operation — Describes how the RF Monitor works.

Preparation for Use — Describes the installation and initial setup of the monitor.

Operating Instructions — Describes the basic operation of the monitor.

Maintenance — Lists routine maintenance tasks as well as troubleshooting and maintenance procedures for common problems. Specifications and parts information are also included.

TABLE OF CONTENTS

Safety Precautions	i
Safety Symbols	ii
Warning Statements	ii
Caution Statements	iii
Safety Statements	iv
About This Manual	vi
Changes to this Manual	vi
Chapter Layout	vi
Chapter 1 Introduction	1
General	1
Items Supplied	1
Items Required	1
Optional Accessories	1
Purpose and Function	1
Functional Description	3
Enclosures	3
Front Panel	3
Chapter 2 Theory of Operation	7
Input Signal	7
Adjustment	7
Operations	7
Reset	7
Chapter 3 Preparation for Use	8
General	8
Unpacking and Inspection	8
Installation	8
Mounting	8
Models 3170B and 3170B400	8
Models 3171B and 3171B020	8
Initial Setup	9
Preparation	9
Adjust Set-Points	10
Active Forward Monitor Setup	11
Dip Switch Settings	11
Chapter 4 Operating Instructions	12
General	12
RF Power Measurement	12
Chapter 5 Maintenance	13
Safety Considerations	13
Preventive Maintenance	13
Cleaning	13
Customer Service	14
Troubleshooting	15
Maintenance Procedures	16
Adjusting the Element Wiper Contact	16
Fuse Drawer/Fuse Replacement	17
Meter Replacement	19
Storing	19
Repackaging	19

Replacement Parts List	19
Line Section Cable Assemblies	20
Meter Cable Assemblies	20
Specifications	21
Element Tables	22
7/8" Line Section	22
Appendix 1 Difference Data Sheet	26
Appendix 2 User Applications and Wiring	27
Connector Assignment	27
Active Forward Monitor (AFM) Input	27
Dry Contact Closure	28
Logic "1" Closure	28
Confirm Output	29
Relay Control	29
LED Indicator	29
Reset Input	30
Remote Contact Reset	30
Remote Metering	31
DC Power Supply Connections	31
Limited Warranty	32

General

This publication refers to the Model 3170B which is a member of the Bird Model 3170B Series of High Speed Wattcher RF Monitors. Models included in the series are listed in [Table 1](#). All models will generally be referred to as a Wattcher unit through out this manual.

The information in this instruction book pertains to all models except noted differences referred to in the text and in the ["Difference Data Sheet" on page 26](#).

Table 1 - Various Models

Model Number	Power Range	Comments
3170B	100 mW - 10 kW	Built in Line Section
3170B400	100 mW - 10 kW	Built in Line Section. No reset or audible alarm function, Extended AFM timing.
3171B	250 W - 100 kW	Uses External Line Section
3171B020	300 W - 60 kW	

Items Supplied

Qty	Description
1	3170B Series High Speed Wattcher
1	AC Power Cord
1	Fuse drawer for 230V operation
2	Fuses for 230 V operation

Items Required

For power monitoring each port must contain a plug-in element. The determination of elements required is based on line section size, frequency band of use and RF power level range. Refer to ["Element Tables" on page 22](#).

Optional Accessories

Bird offers a larger number of cable assembly lengths for remote line sections and meters. For different power or frequency requirements see ["Element Table Selection" on page 22](#).

Purpose and Function

The Model 3170B Series High Speed Wattcher unit is a two channel power monitoring system for use in 50 ohm coaxial transmission lines. Adjustable set points allow user to preset maximum reflected and minimum forward power trip points.

Activated audible/visual alarms indicate an erroneous condition present on the transmission line. Corrective action can then be followed to either protect transmission equipment or restore transmission line to operational characteristics. This power monitoring capability is accomplished through the use of a dual port 50 ohm insertion type line section. Each port must contain a standard Bird Electronic Corporation plug-in element. Usually elements with a ten to one ratio is recommended for the forward and reverse power levels.

The Wattcher monitoring system also provides additional terminal connections for user specific applications. For details and wiring information, [see "User Applications and Wiring" on page 27.](#)

Functional Description

Enclosures

The Wattcher Monitor's internal circuitry is enclosed in an aluminum housing. This housing is mounted to a standard 19-inch panel for rack mount applications.

Front Panel

Figure 1 Front Panel

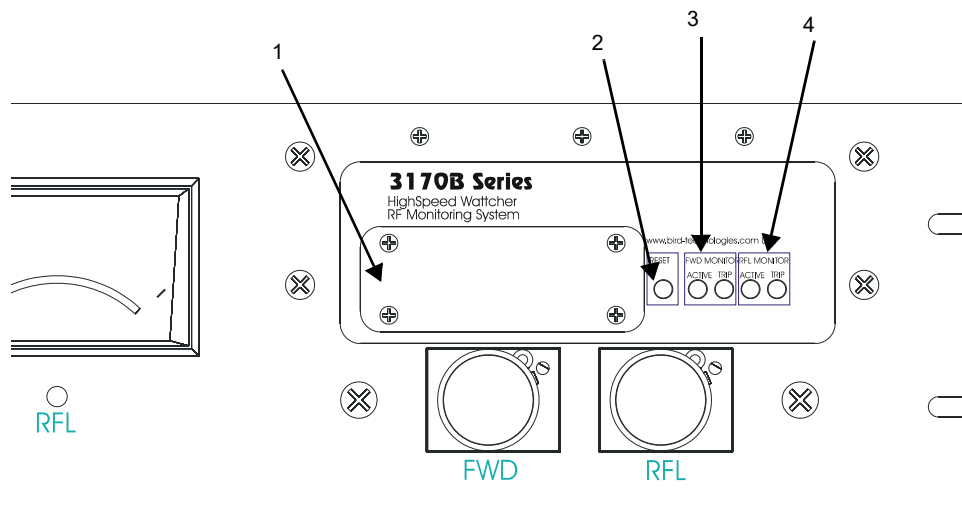

Table 2 - Front Panel

1	Alarm/Setpoint Faceplate	If forward or reflected power set points are exceeded an audible alarm is sounded. The alarm works in conjunction with error status indicator reflecting failure conditions.
2	Reset	This push button resets the monitoring system to normal operation after an error condition has been corrected.
3	Forward Monitor	Active LED—Indicates forward power is being monitored and an error condition will be indicated upon failure. Trip LED—Indicates error condition has occurred.
4	Reflected Monitor	Active LED—Indicates reflected power is being monitored and an error condition will be indicated upon failure. Trip LED—Indicates error condition has occurred.

Figure 2 Rear Panel

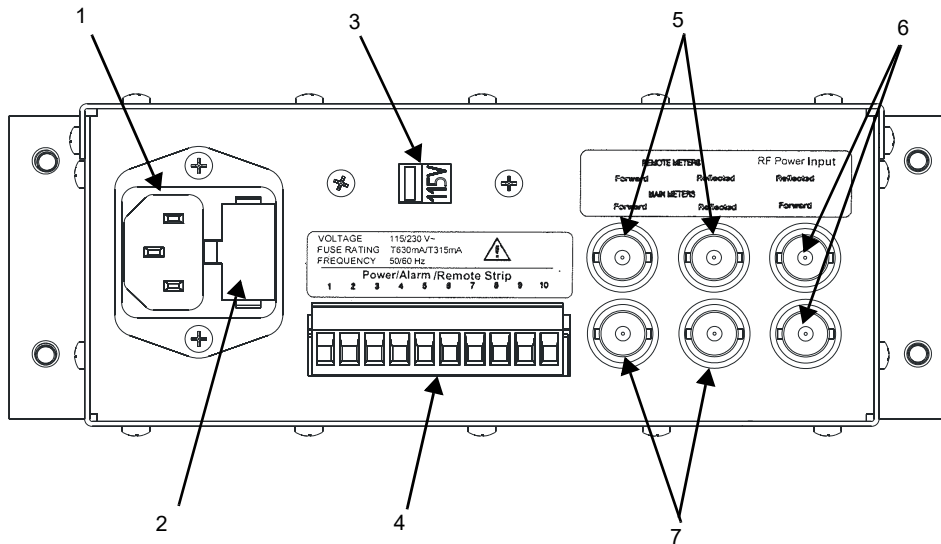

Table 3 - Rear Panel

1	AC Receptacle	Provides a means of supplying AC line power to Wattcher control unit.
2	AC Line Fuse	Slow-blow fuse, provides circuit protection from excessive surge inline power or in the event of component failure.
3	Line Voltage Selector Switch	Determines line voltage operation (115 or 230VAC).
4	Power/Alarm/Remote Terminal Strip	Provides connection for external DC supply, auxiliary alarm input and output, reset input and output, remote confirm output and auxiliary 5V output. See "User Applications and Wiring" on page 27.
5	Remote Meter Connections	Extra meter connections for remote meters. For details on connecting remote meters see "User Applications and Wiring" on page 27. Levels: 1.038V full scale. Use 33.2k resistor in series with standard Bird 30mA meters.
6	RF Power Input Connections (from line section)	Female BNC connectors, provide means of connecting sampled RF power. Forward and Reflected power connectors are labeled as such. Levels: 30µA full scale into 1400Ω (42mV). May be overranged to 100mV.
7	Meter Connections	Connectors for front panel main meters. Can also be used to connect remote meters. Levels: 30mA full scale into 1400 ohm (42mV).

Figure 3 Models 3170B and 3170B400

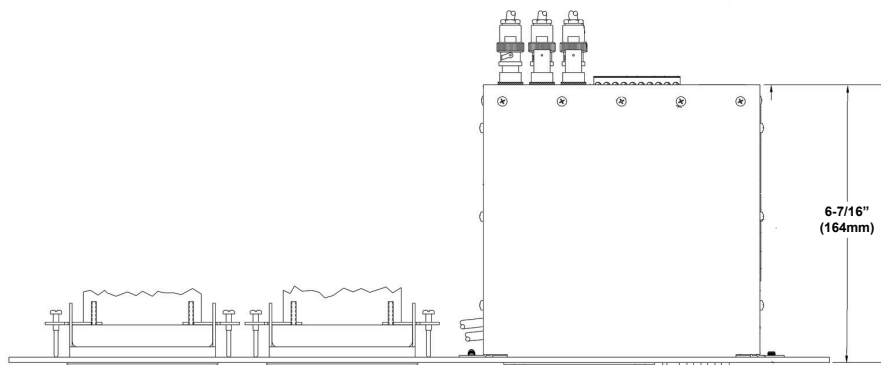
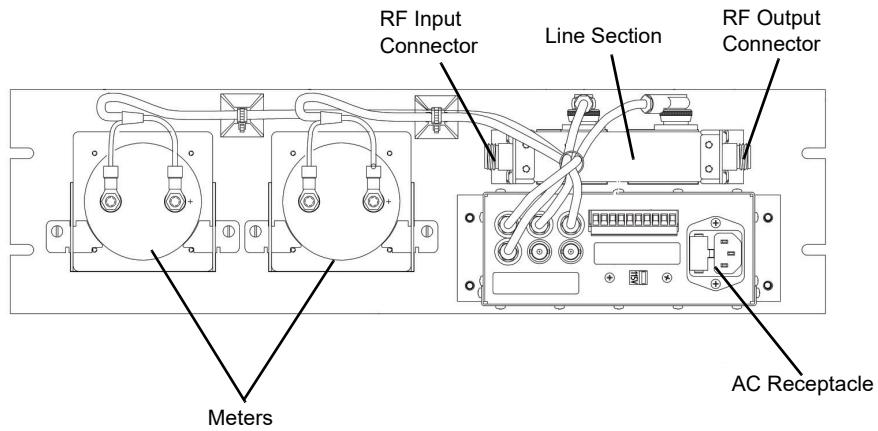
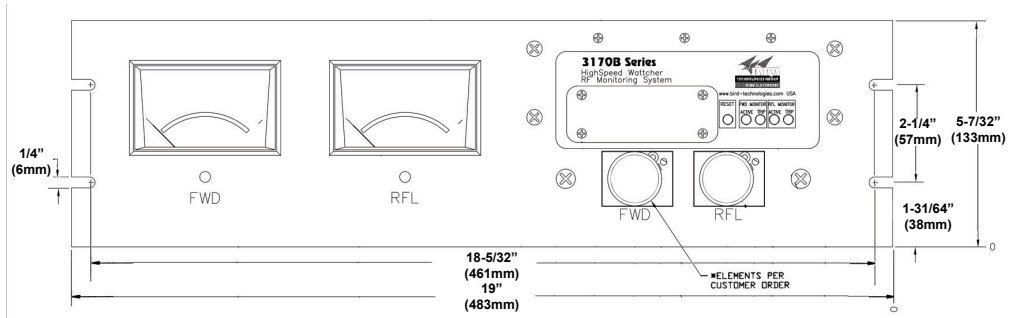
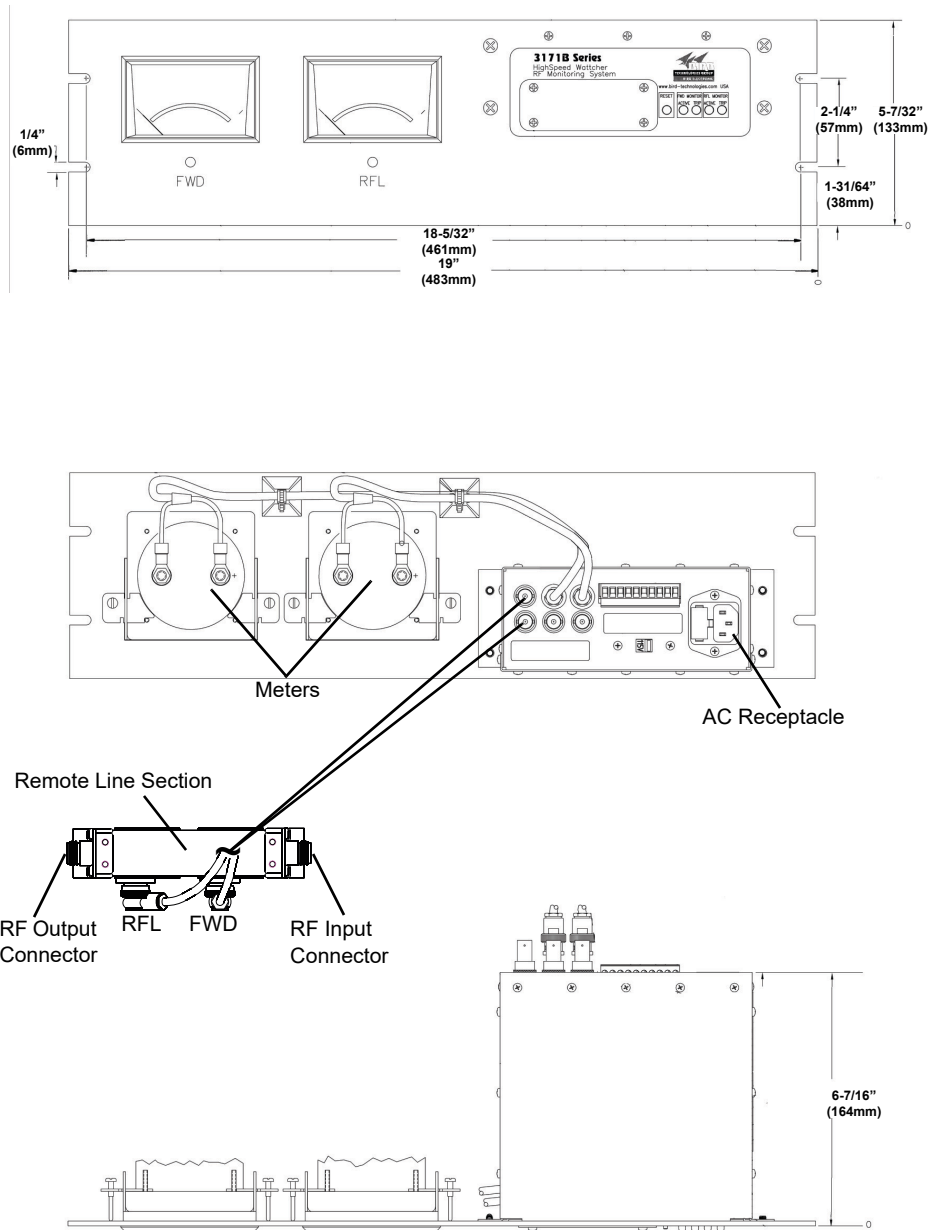

Figure 4 Models 3171B and 3171B020



Input Signal

Direct current signals representing operating power levels are brought into the RF monitor from the sensing elements through the rear panel jacks labeled RF Power Input Forward and Reflected. These currents are shunted to ground through 1400 ohm resistors. The voltage developed across these resistors is amplified by a pair of operational amplifiers to approximately one volt (meter full scale).

The drive current to the main indicating meters is taken from the amplifier outputs through series resistors of 33.2k ohm each. The drive voltage for remote meters also comes from the amplifier outputs and is buffered by a pair of op-amps configured for unity gain. This protects the 3170B/71B circuitry against accidental shorting of the remote meter line.

Adjustment

The calibrate/operate switch and the two reference potentiometer allow the user to substitute an adjustable current in place of the signals from the sensing elements to facilitate adjustment of the set-points.

The three set-point potentiometer (forward, reflected, and confirm) provide DC voltages which are compared to the amplifier outputs by three comparators.

The LED to the left of each potentiometer indicates whether the incoming signal is higher (LED ON) or lower (LED OFF) than the set-point of the potentiometer.

Operations

The output of the confirm comparator goes directly to the confirm output drive transistors. The output of the reflected comparator goes directly to the alarm circuitry and to the reflector monitor tripped LED latch. The output of the forward comparator is gated by the activate forward monitor signal AFM before going to the alarm circuitry and LED latch.

In other words, the signal is blocked if the activate forward monitor signal is not present. The AFM signal passes through a delay circuit before reaching the gate. The purpose of the delay is to allow for any delays in the user's equipment between the initial excitation of the carrier ON signal and the presence of power on the transmission line.

Reset

The reset signal clears the horn latch and the two trip LED latches. This signal can come from three sources: the push button switch on the front panel, the rear panel input/output, or from the power-up reset capacitor when the device is first turned on or after a power interruption.

General

The series 3170B High-Speed Wattcher RF Monitoring System was designed for indoor use. This section contains information on unpacking and inspection; and preparing the Wattcher Unit for use.

Unpacking and Inspection

1. Carefully inspect shipping container for signs of damage. If damage is noticed, do not unpack the unit. Immediately notify the shipping carrier and Bird Electronic Corporation.
2. If container is not damaged, unpack the unit. Save shipping materials for repackaging.
3. Inspect unit for visual signs of damage. Immediately notify the shipping carrier and Bird Electronic Corporation of equipment damage.

Installation

Mounting

The Model 3170B Series High Speed Wattcher System is intended for rack panel mounting. The panels are designed to fit ASA standard 19 inch size "C" racks.

The Models 3170B and 3170B400 are fully self-contained units with the RF line section mounted on the panel. The Models 3171B and 3171B020, however, utilize remotely mounted line sections.

CAUTION

Be sure the 115/230 voltage selector switch on the rear panel is set to the proper line voltage before AC power is applied.

Note: For installation of Models 3170B and 3170B400 refer to [Figure 3 on page 5](#). For installation of Models 3171B and 3171B020, refer to [Figure 4 on page 6](#).

Models 3170B and 3170B400

Note: If the back of the unit is not accessible from the rear of the rack mount, any connections to the unit must be made before the panel is secured in place.

1. Connect the RF coaxial transmission line to the line section.
2. Ensure the 115/230 line voltage switch is in the proper position for the voltage supplied.

Note: 3170B series Wattcher is shipped with a fuse and fuse drawer set for 115V operations. For 230V operations, see ["Changing Fuse Drawer for 230V Operation" on page 17](#).

3. Connect the AC power cord from the Wattcher unit to an appropriate source.

Note: Make DC power connections if needed.

4. Secure the panel to the rack with appropriate fasteners.

Models 3171B and 3171B020

1. Insert the line section in the coaxial RF coaxial transmission line.
2. Connect the DC cable to the line section.
3. Run the DC cable to the rack console unit.

Note: If the back of the unit is not accessible from the rear of the rack mount, all connections to the unit must be made before the panel is secured in place.

4. Ensure that the 115/230 line voltage switch is in the correct position for the voltage supplied.

Note: 3170B series Wattcher is shipped with a fuse and fuse drawer set for 115V operations. For 230V operations, [see "Changing Fuse Drawer for 230V Operation" on page 17.](#)

5. Connect the AC power cord from the Wattcher unit to an appropriate source.

Note: Make DC power connections if needed.

6. Secure the panel to the rack mount using appropriate fasteners.

Initial Setup

Preparation

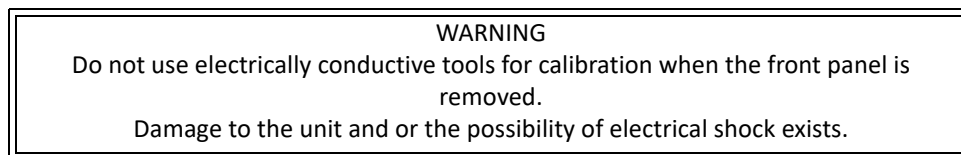

Checking the LED Light

When either AC or DC power is applied to the unit, the yellow reflected monitor active LED should light. If this light does not come on, disconnect the power cord and refer to Chapter 5, Maintenance. With the yellow reflected monitor active LED lit, signifying power is ON and the unit is operational, proceed with the initial setup below.

Removing the Faceplate

1. Remove the four screws found in the corners of the faceplate.

Note: This exposes the circuit board on which the calibration controls are located.

2. Set the CALIBRATE/OPERATE switch to the calibrate position (to the left).

Figure 5 Face Plate Removal

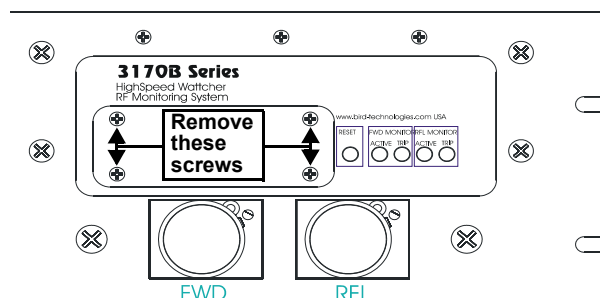
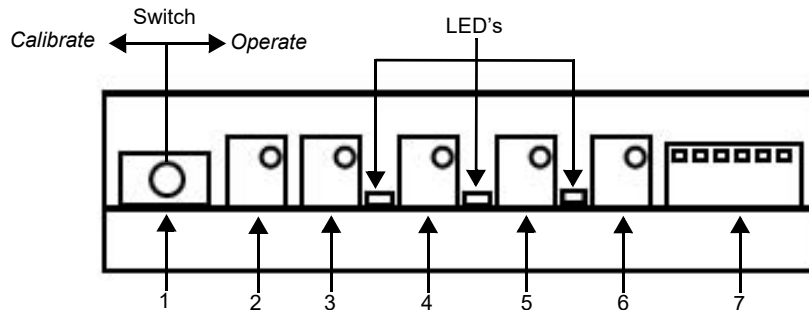

Figure 6 Controls and Indicators



1	Calibrate/Operate Switch
2	Forward Reference Adjustment Potentiometer
3	Reflected Reference Adjustment Potentiometer
4	Forward Set Point Potentiometer
5	Reflected Set Point Potentiometer
6	Confirm Set Point Potentiometer
7	Forward Monitor Active Delay Dip Switch

Adjust Set-Points

1. Set the CALIBRATE/OPERATE switch to the CALIBRATE position (to the left).
2. Do one or more of the following:
 - Set the Forward Power Level Alarm Trip Point
 - a. Adjust the forward reference potentiometer to set the meter to indicate the power level at which the forward alarm is to be tripped.
 - b. Adjust the forward set-point potentiometer until the miniature LED to the left of the potentiometer is just at the transition from off to on.

Note: *Turning the potentiometer clockwise will raise the set-point and turn the light off.*
 - Set the Reflected Power Level Alarm Trip Point
 - a. Set the reflected trip point, on the reflected potentiometers, in a similar manner to the forward trip point. See ["Set the Forward Power Level Alarm Trip Point" on page 10.](#)

Note: *The alarm will trip during this operation. It can be reset when completed.*
 - Set the Confirm Set-Point
 - a. Adjust the forward reference potentiometer to set the trip point level.
 - b. Adjust the confirm set-point potentiometer until the miniature LED to the left of the potentiometer is just at the transition from off to on.

Note: *If the confirm output is not used, it is not necessary to adjust the confirm set-point potentiometer.*
3. Return the CALIBRATE/OPERATE switch to the OPERATE position (to the right).

Active Forward Monitor Setup

Note: Internal circuitry sets Active Forward Monitor (AFM) input to a high state. This inhibits monitoring of forward power on transmission line. To monitor forward power, follow the steps below.

1. Connect AFM input to ground by hardwiring terminal strip position 10 (AFM input) to position 7 (ground).
2. Select the appropriate delay (see [Table 4](#)).

Note: This delay allows transmitting equipment to reach acceptable power output before being monitored by forward channel for low power condition.

3. Do one of the following:
 - **If the delay in the user's equipment is known:** the AFM should be set to the same delay plus a minimum of 25 percent safety factor.
 - **If the delay in the user's equipment is unknown:**
 - c. Set the AFM to progressively shorter delays until switching on the carrier causes the FWD monitor to trip when the user's equipment is known to be working properly.
 - d. Add a 25 percent safety factor to the delay indicated by the switch setting and set the delay to that setting.

Note: That the disabling of the forward monitor is virtually instantaneous when the AFM signal is removed and is unaffected by the switch settings.

Dip Switch Settings

Dip Switch bank SW2 is used to select AFM delay time. Refer to [Figure 7](#) for correct on/off position. Ensure the switches or set fully on or off.

In [Table 4](#) the delay times are listed in the appropriate row & column for the switch settings.

Figure 7 SO2 Dip Switch

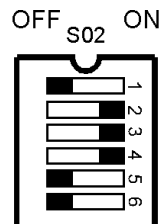

Table 4 - Setting AFM Delay

			SW6 ON SW5 OFF SW4 OFF		SW6 OFF SW5 ON SW4 OFF		SW6 OFF SW5 OFF SW4 ON	
SW1	SW2	SW3	3170B400	All models	3170B400	All other models	3170B400	All other models
ON	ON	ON	7.1ms	71μs	71ms	710μs	710ms	7.1ms
OFF	ON	ON	8.3ms	83μs	83ms	830μs	830ms	8.3ms
ON	OFF	ON	10.0ms	100μs	100ms	1ms	1s	10.0ms
OFF	OFF	ON	12.1ms	121μs	121ms	1.21ms	1.21s	12.1ms
ON	ON	OFF	16.7ms	167μs	167ms	1.67ms	1.67s	16.7ms
OFF	ON	OFF	25.0ms	250μs	250ms	2.5ms	2.5s	25ms
ON	OFF	OFF	50.0ms	500μs	500ms	5.0ms	5.0s	50ms

General

When the unit is installed and connected to a transmitter for remote monitoring, metering, or external alarms and functions as your installation requires, operator attention is not required. The equipment will completely monitor a transmitter's operation. The only time operating personnel will be necessary is to reset the unit if it has not been wired for automatic or remote reset. Refer to "[User Applications and Wiring](#)" on page 27 for different applications in which the Watcher monitor can be used.

RF Power Measurement

RF power measurements are made by the insertion of the detector elements into the line section. The elements are selected for the frequency range and power level used.

Forward and reflected power is indicated when the arrow on the element plate points in the direction of power flow. The forward power flows from the transmitter to the load or antenna and the reflected power flows from the load or antenna to the transmitter.

When the detecting element is placed in the line section, be sure it is fully seated and fully rotated to the stop for the appropriate indicating position. Also be sure the element catch on the element socket face of the line section is in place on the shoulder of the element. This will assure good contact between the element and line section body.

Elements are selected for the power and frequency range required. Since the reflected power is generally much less than the forward power, it may be beneficial to select an element of lower power value for the reflected side. This will allow better reading resolution. Generally elements of a ten to one ratio are used.

Safety Considerations

WARNING

Become thoroughly familiar with modern methods of resuscitation before working near high voltage sources.

WARNING

Shock hazard. Always turn off AC power before removing any equipment panels.

Preventive Maintenance

Note: *Preventive maintenance is limited to cleaning the unit and connectors.*

WARNING

Disconnect this unit from AC power source before any disassembly for cleaning, repair or replacement procedures. The potential for electrical shock exists.

Cleaning

WARNING

When using dry cleaning solvents, provide adequate ventilation and observe normal safety precautions. Many dry cleaning agents emit toxic fumes that may be harmful to your health if inhaled.

Front Panel

Clean the front panel face and meters with a soft cloth dampened with a mild detergent solution. Do not use an excessive amount of water that would enter the unit and damage electrical components.

Line Section

Clean the line section connectors and elements with a dry cleaning solvent. Use a clean cloth to clean the mating surfaces of the larger line sections and a cotton swab stick for the smaller connectors, elements, and line section element socket. Clean all mating surfaces thoroughly, especially the bottom shoulder of the element socket and the spring contact finger.

CAUTION

Do not bend this contact finger when cleaning. The position of this contact is somewhat critical. If it is out too far the element will not enter the socket and if it is in too far, it will not make contact with the button on the element. For contact adjustments, refer to "[Adjusting the Element Wiper Contact](#)" on page 16.

Customer Service

Any maintenance or service procedure beyond the scope of those in this chapter should be referred to a qualified service center.

If the unit needs to be returned for any reason, request an Return Material Authorization (RMA) through the Bird Technologies website. All instruments returned must be shipped prepaid and to the attention of the RMA number.

Bird Service Center

30303 Aurora Road
Cleveland (Solon), Ohio 44139-2794
Fax: (440) 248-5426
E-mail: bsc@birdrf.com

For the location of the Sales Office nearest you, visit our Web site at:

<http://www.birdrf.com>

Troubleshooting

Locate the problem, review the possible cause, and perform the corrective action listed.

Note: Only those functions within the scope of normal maintenance are listed. This manual can not list all malfunctions that may occur, or corrective actions. If a malfunction is not listed or not corrected by the listed corrective actions, notify a qualified service center.

Table 5 - Troubleshooting

PROBLEM	CAUSE	AREAS TO CHECK / CORRECTION
Active LED does not illuminate	No Line Power	Check power source, restore Defective line cord.
	Fuses Opened	Check fuses, replace if needed. See " Fuse Drawer/ Fuse Replacement " on page 17.
	Defective monitor circuitry.	Return Watcher, line section, and elements to the factory. See " Customer Service " on page 14.
	Line voltage selector switch in wrong position.	Set switch to proper operating voltage.
No meter indication	No RF power	Check RF source.
	Arrow on plug-in element pointing in wrong direction	Change position of element.
	No pickup from DC wiper contact	Adjust wiper contact. See " Adjusting the Element Wiper Contact " on page 16.
	Open or short circuit in DC meter cable	Replace defective DC meter cable.
	Open or short circuit in line section circuit in cable.	Replace defective cable.
	Meter burned out or damaged	Replace defective meter. See " Meter Replacement " on page 19.
	Defective monitor circuitry.	Return Watcher, line section, and elements to the factory. See " Customer Service " on page 14.
Intermittent or inconsistent meter readings	Faulty transmission line	Inspect line connectors. Replace defective connector.
	Dirty DC contact on elements	Clean DC contacts. See " Cleaning " on page 13.
	Sticky or defective meter	Replace defective meter. See " Meter Replacement " on page 19.
Reflected meter pointer max out with RF power applied.	Meter/Line section cables reversed.	Connect reflected cable to proper BNC connector on rear panel.
High VSWR or reflected power	Bad load or poor connectors.	Replace load or connectors.
	Shorted or open transmission line.	Have transmission line serviced.
	Foreign material in the line section or in RF connector bodies.	Remove foreign material. See " Cleaning " on page 13.
Remote meter pointer is maxed out.	Series resistor not installed.	Series resistor of 33.2 K are required for each remote meter.
Unit does not operate from external DC source.	Fuse opened.	Replace fuse, but check maximum voltage of DC source. See " Replacing Fuse for External DC Input Voltage " on page 18.

Maintenance Procedures

Adjusting the Element Wiper Contact

WARNING
Never attempt to adjust wider contact with RF power applied to the transmission line.

CAUTION
If the element cannot be fully inserted into the socket, do not force it. You might damage the element wiper contact.

CAUTION
Be careful not to bend element wiper contact out too far as to interfere with insertion of the elements.

Note: Continuous insertion or rotation of the element might cause a slight change in the position of the contact spring in the element socket. If the contact spring changes position, erratic power readings may be experienced.

Note: For this procedure, use a small flat head screwdriver.

1. Place the flat side of the screwdriver behind the contact bar. See [Figure 8 on page 16](#).
2. Bend the contact bar so that the contact rests in the center of the slot adjacent to the element socket.
3. Bend the contact bar slightly toward the center of the element socket bore.
4. Ensure the profile of the element contact is visible when viewing the element socket from the top of the socket bore.

Note: If the contact is accidentally moved too far into the element bore, the element will not slide into the socket. Move the contact back into the recessed area and repeat the process.

Figure 8 Adjust Element Contact Up and Down

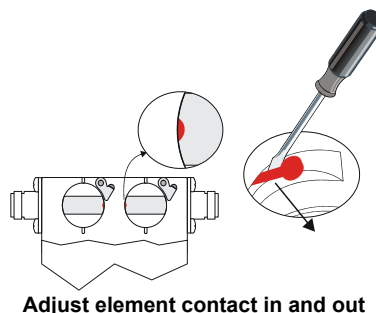
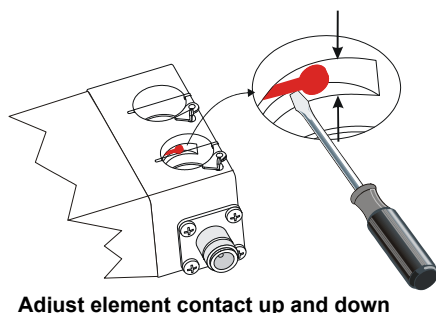

Fuse Drawer/Fuse Replacement

Changing Fuse Drawer for 230V Operation

Note: 3170B series Wattcher is shipped with fuse and fuse drawer set per 115V operation.

WARNING
Disconnect this unit from AC power source before any disassembly for cleaning, repair or replacement procedures. The potential for electrical shock exists.

1. Depress the release tabs on both sides of the fuse drawer.
2. Pull out from AC receptacle housing.

Note: Note the orientation of the fuse drawer and the fuse contained within. Also note that for 115V operation there is a shorting bar insert in the neutral side of the AC line.

3. Insert optional fuse drawer with two 315 mA fuse install.
4. Push fuse drawer in housing cavity until release tabs snap into place.

Figure 9 Changing the Fuse Drawer

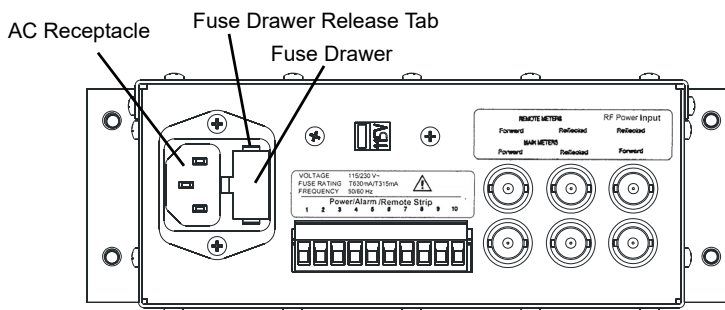

Replacing Blown Fuse

Note: For either 115 or 230 Volt Operation.

1. Depress the release tabs on both sides of the fuse drawer.
2. Replace blown fuse.

Operating Voltage	Fuse	
	Bird PN	Type
115 V	5A2257-14	5x20 mm, Slo-Blo, T630 mA
230 V	5A2257-11	5x20 mm, Slo-Blo, T315 mA

3. Insert fuse drawer into housing cavity.
4. Push until release tabs snap into place.

Figure 10 Fuses

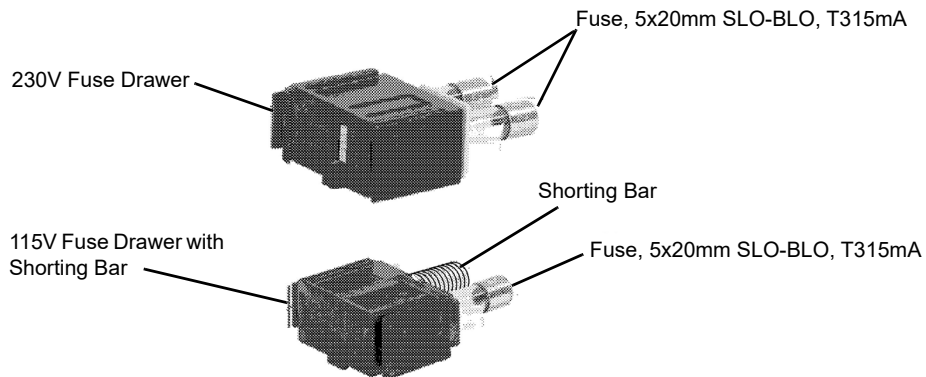

Replacing Fuse for External DC Input Voltage

WARNING
Disconnect this unit from AC power source before any disassembly for cleaning, repair or replacement procedures. The potential for electrical shock exists.

1. Remove the five 4-40 screws from the cover top.
2. Remove the six 4-40 screws from the cover sides.
Note: Three screws from each side.
3. Remove the cover from lower housing to expose internal circuit.
4. Locate fuse on PC board assembly near the AC input receptacle.
5. Remove the fuse.
6. Replace with 3 AG type fast-acting rated at .5 amp.
7. Replace cover and screws.

Figure 11 Replacing Fuse for External DC Input Voltage

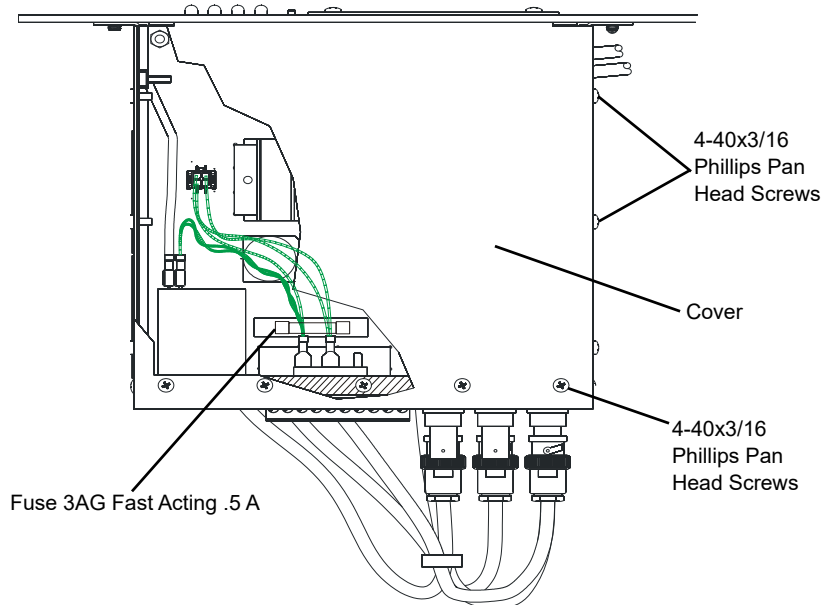

Meter Replacement

If the meters should become defective and require replacement, proceed as outlined in the following steps:

1. Observe the connections of the meter leads.
2. Disconnect the leads.

Note: *This will insure the correct polarity in reassembly.*

3. Loosen the clamp screw on the sides of the meter until the clamp is released.
4. Withdraw the meter through the front panel.
5. Reverse the above steps to install the new meter.

Storing

If the unit is not to be used for an extended period of time, store in a cool dry place where it will be free from rough treatment, dust, and dampness.

Repackaging

Should you need to return the Wattcher unit, use the original shipping package if possible. If the original package is not available, use a heavy duty corrugated box with shock-absorbing material around all sides of the unit to provide firm cushion and to prevent movement in container. Container should be properly sealed.

Replacement Parts List

Qty	Description	Part Number
1	AC power fuse 115V, 5x20 mm, Slo-Blo, T630 mA	5A2257-14
2	230V, 5x20 mm, Slo-Blo, T315 mA	5A2257-11
1	DC power fuse, 3 AG, 1/2 A	5-721-2
1	Power cord, 115/230 VAC	4421-055
2	Cable assembly (Line Section)	3170-058-1
2	Meter cable assembly	3170B110
2	Meter Models 3170B, 3170B400 Model 3171B Model 3171B020	2150A015-1 2150A086-1 2150A093-1
1	Line section assembly (Model 3170B and 3170B400 only)	4522-002-7
2	Bezel kit (for all meters)	2150A015-2

Line Section Cable Assemblies

Length	Part Number
14"	3170-058-1
6'	3170-058-6
15'	3170-058-2
25 [*]	3171-010
25'	3170-058-3
40'	3170-058-4
50'	3170-058-5
80'	3170-058-7
90'	3170-058-8
100'	3170-058-9

* Use if line section is 6-1/8"

Meter Cable Assemblies

Note: Cables are terminated with ring terminals that fit 1/4" meter studs.

Length	Part Number
2'	3170B110
6'	3170B110-6
15'	3170B110-15
25'	3170B110-25
50'	3170B110-50

Specifications

Impedance	50 Ohms nominal
Power Range Models 3170B, 3170B400 Model 3171B Model 3171B020.	100 mW to 10 kW full scale 250 W to 100 kW full scale 300 W to 60 kW full scale
Indicated Power Accuracy	5% of full scale
Alarm Accuracy	5% of full scale
Response Time	25 μ sec maximum
Activate Forward Monitor (Adjustable Delay) Models 3170B, 3171B, & 3171B020 3170B400	71 μ sec to 50 ms nominal 7.1 ms to 5 seconds nominal
Activate Forward Monitor (Signal Levels) Models 3170B, 3171B, 3171B020, and 3170B400	Active state: 0 to 1 V Off state: held to 5 V internally
Inputs and Outputs	Will interface directly to TTL
Output Drive Capability for Alarm and Confirm only	Will sink 1.5A mA
5 Volt Supply Output	Will source 360 mA, regulated
Insertion VSWR	1.05 maximum dc to 1 GHz
Power Requirements AC Power Requirements DC Power Requirements	115/230 VAC 50/60 Hz @ 56 mA maximum 12.7 VDC to 16.0 VDC @ 400 mA maximum
Overall Dimensions	7-23/32"D x 19"W x 5-7/32"H (237 x 483 x 133 mm)
Weight Models 3170B, 3170B400 Models 3171B, 3171B020	6 lb. (2.5 kg) 4.2 lb. (1.9 kg)

* Depth dimensions does not include additional depth allotted to cable assemblies.

Element Tables

The following tables are used to determine the part numbers of elements required based on line section, power, and frequency ranges.

[Table 6](#) should be used to determine which element table to use, based on the model.

Note: [Table 7](#) through [Table 18](#) on [page 25](#) are numbered consecutively for convenience. The table heading corresponds to the table heading in the Bird catalog which is the common reference for element tables.

Table 6 - Element Table Selection

Model	Line Section Mount		Meter Scale			Line Section in Inches			
	Front Panel	External	Watts	kilowatts		7/8	1 5/8	3 1/8	6 1/8
			25/50/100	5/10/25	15/30/60	Element Table (2-)			
3170B	4		4			7 to 12			
3170B400	4		4			3 to 8			
3171B		4		4			13	15	17
3171B020		4			4		14	16	18

7/8" Line Section

Note: The following tables are used to select elements for 7/8" line sections.

Table 7 - Selection Table

Power Range (Watts)	Frequency					
	2 - 30	25 - 60	50 - 125	100 - 250	200 - 500	400 - 1000
5	--	5A	5B	5C	5D	5E
10	--	10A	10B	10C	10D	10E
25	--	25A	25B	25C	25D	25E
50	50H	50A	50B	50C	50D	50E
100	100H	100A	100B	100C	100D	100E
250	250H	250A	250B	250C	250D	250E
500	500H	500A	500B	500C	500D	500E
1000	1000H	1000A	1000B	1000C	1000D	1000E
2500	2500H					
5000	5000H					

Table 8 - High Frequency Milliwatt Elements - Entire Table (8% FS)

Power Range (milliwatts)	Frequency						
	950 - 1260	1250 - 1500	1500 - 1700	1700 - 2200	2300 - 2400	2400 - 2500	2500 - 2600
100	430-82	430-209	430-210	430-178	430-211	430-182	--
250	--	--	--	430-1	430-239	430-240	430-241
500	--	430-259	--	430-95	--	430-159	--

Table 9 - Low Frequency Elements

Power Range (Watts)	Frequency Bands (Mhz)
	.45 - 2.5
1000	1000P
2500	2500P
5000	5000P
10000	10000P

Table 10 - Low Power Elements

100 mW Frequency Band (MHz)	Cat. No	250 mW Frequency Band (MHz)	Cat. No	500 mW Frequency Band	Cat. No
45-50	430-266	45-50	430-267	45-54	430-242
50-60	430-191	50-60	430-212	54-60	430-243
60-66	430-192	60-66	430-213	60-66	430-244
66-72	430-193	66-72	430-214	66-72	430-245
72-76	430-2	72-76	430-22	72-76	430-33
76-82	430-194	76-82	430-215	76-88	430-246
82-88	430-195	82-88	430-216	88-108	430-247
88-97	430-170	88-108	430-217	105-120	430-26
97-108	430-171	105-120	430-20	120-136	430-248
108-136	430-57	116-126	430-48	136-150	430-249
135-175	430-86	125-136	430-218	150-170	430-53
170-190	430-62	130-150	430-13	170-190	430-250
190-210	430-63	150-180	430-15	190-216	430-251
210-216	430-176	170-190	430-64	216-240	430-252
216-230	430-196	190-210	430-65	240-290	430-27
230-240	430-197	210-220	430-184	290-340	430-253
240-250	430-198	216-230	430-219	340-360	430-157
250-260	430-199	230-240	430-220	350-400	430-254
260-270	430-200	240-250	430-221	400-450	430-255
270-280	430-201	250-260	430-222	450-500	430-256
280-290	430-202	260-270	430-223	500-600	430-257
290-300	430-203	270-280	430-224	600-800	430-258
300-320	430-204	280-290	430-225	800-1000	430-265
320-340	430-205	290-300	430-226		
340-360	430-164	300-320	430-227		
360-380	430-206	320-340	430-228		
380-400	430-207	340-360	430-229		
400-420	430-7	360-380	430-230		
420-450	430-208	375-400	430-231		
450-470	430-8	400-450	430-232		
470-500	430-179	450-470	430-61		
500-600	430-168	470-500	430-233		
600-800	430-169	500-600	430-234		
800-1000	430-263	600-800	430-235		
		800-1000	430-264		

Table 11 - Low Frequency Elements

Power Range (Watts)	Frequency					
	2 - 30	25- 60	50 - 125	100 - 250	200 - 500	400 - 1000
100 W	--	100A12	100B12	100C12	100D12	100E12
250 W	--	250A12	250B12	250C12	250D12	250E12
500 W	500H12	500A12	500B12	500C12	500D12	500E12

Table 12 - High Frequency Elements Entire Table (8% FS) - Milliwatt Elements

Power Range (Watts)	Frequency Bands (Mhz)							
	905 - 1260	1100 - 1800	1700 - 2200	2200 - 2300	2300 - 2400	2400 - 2500	2500 - 2600	2600 - 2700
1	1 J	1 K	1 L	1 M	431 - 17	431 - 20	431 - 23	431 - 120
2.5	2.5 J	2.5 K	2.5 L	2.5 M	431 - 110	431 - 107	431 - 108	431 - 117
5	5 J	5 K	5 L	5 M	432-15	432-28	432-2	432-12

Line Section

Note: The following tables are used to select elements for 1-5/8" line sections.

Table 13 - 1-5/8" AA Standard Elements 30mA

Power Range	Frequency			
	2 - 30	50 - 125	100 - 250	400 - 1000
100 W	--	100B12	100C12	100E12
250 W	--	250B12	250C12	250E12
500 W	500H12	500B12	500C12	500E12
1000 W	1000H12	1000B12	1000C12	1000E12
2500 W	2500H12	2500B12	2500C12	2500E12
5000 W	5000H12	5000B12	5000C12	5000E12
10 kW	10KH12	10KB12	--	--
25 kW	25KH12	25KB12	--	--

Table 14 - 1-5/8" BB Standard Elements 30mA

Power Range	Frequency			
	2 - 30	50 - 125	100 - 250	400 - 1000
600 W	600H12	600B12	600C12	600E12
1500 W	1500H12	1500B12	1500C12	1500E12
3000 W	3000H12	3000B12	3000C12	3000E12
6000 W	6000H12	6000B12	6000C12	6000E12
15 kW	15KH12	15KB12	--	--

Table 15 - 3-1/8" AA Standard Elements 30 μ A

Power Range	Frequency			
	2 - 30	50 - 125	100 - 250	400 - 1000
100 W	--	100B32	100C32	100E32
250 W	--	250B32	250C32	250E32
500 W	500H32	500B32	500C32	500E32
1000 W	1000H32	1000B32	1000C32	1000E32
2500 W	2500H32	2500B32	2500C32	2500E32
5000 W	5000H32	5000B32	5000C32	5000E32
10 kW	10KH32	10KB32	10KC32	10KE32
25 kW	25KH32	25KB32	25KC32	25KE32
50 kW	50KH32	50KB32	50KC32	--
100 kW	100KH32	--	--	--

Table 16 - 3-1/8" BB Standard Elements 30 μ A

Power Range	Frequency		
	50 - 125	100 - 250	400 - 1000
600 W	600B32	600C32	600E32
1500 W	1500B32	1500C32	1500E32
3000 W	3000B32	3000C32	3000E32
6000 W	6000B32	6000C32	6000E32
15 kW	15KB32	15KC32	15KE32
30 kW	30KB32	30KC32	30KE32

Table 17 - 6-1/8" AA Standard Elements 30 μ A

Power Range (Watts)	Frequency			
	2 - 30	50 - 125	100 - 250	400 - 1000
250 W	--	--	250C62	250E62
500 W	--	500B62	500C62	500E62
1000 W	1000H62	1000B62	1000C62	1000E62
2500 W	2500H62	2500B62	2500C62	2500E62
5000 W	--	5000B62	5000C62	5000E62
10 kW	10KH62	10KB62	10KC62	10KE62
25 kW	--	25KB62	25KC62	25KE62
50 kW	50KH62	50KB62	50KC62	50KE62
100 kW	100KH62	100KB62	100KC62	--

Table 18 - 6-1/8" BB Standard Elements 30 μ A

Power Range	Frequency		
	50 - 125	100 - 250	400 - 1000
3000 W	3000B32	3000C32	3000E32
6000 W	6000B32	6000C32	6000E32
15 kW	15KB32	15KC32	15KE32
30 kW	30KB32	30KC32	30KE32
60 kW	60KB32	60KC32	60KE32

APPENDIX I

DIFFERENCE DATA SHEET

Note: Table A-1 is used to outline the differences between various models.

Table 19 - Differences Between Models

Model	Line Section Mount		Meter Scale			AFM Delay Adjustment Range	
	Front Panel	External	Watts 25/50/ 100	kilowatts 5/10/25	15/30/60	71 μ s to 50 ms	7.1 ms to 5 seconds
3170B	4		4			4	
3170B400	4		4				4
3171B		4		4		4	
3171B020		4			4	4	

This section is a collection of user specific applications and the wiring information required to activate them.

Connector Assignment

Table 20 - BNC Jacks

Connection	Description	Function	Levels
RF Power Input Forward/Reflected	DC Input Forward & Reflected	Detected RF signals from sensors	30 μ A full scale into 1400 Ω (42mV). May be overranged to 100mV
Main Meter Forward/Reflected	DC Main Meter Drive Output	Current to drive indicating meters	30mA full scale into 1400W (42mV)
Remote Meters Forward/Reflected	DC Remote Meter Drive Output	Voltage to drive remote indicating meters	1.038V full scale (use 33.2k resistor in series with standard Bird 30mA meters)

Table 21 - Terminal Strip

Connection	Description	Function	Levels
TB1(+), TB2(-)	External 12V Supply	Used to allow mobile operation	See Figure 18 on page 31 for connection information
TB3,4	Auxiliary Alarm Inputs	Signals to trip alarms from external sources	TTL levels, active low. Pulled up to 5V by 4.7k internally. Shunted to ground by 0.1 μ F capacitor.
TB5	5V Output	Regulated 5V out put	Can supply 360mA max.
TB6	Alarm Output	Low when alarm is sounding, returned high by reset	Active low. Pulled up to 5V by 4.7k. Will sink 1.5A and source 1mA.
TB7	Ground	Chassis ground	Reference for signals.
TB8	Reset Input /Output	Input to reset Wattcher from external source. May be used as an output to reset other equipment when Wattcher is reset by the front panel switch.	TTL levels, active low. Pulled up to 5V by 4.7k internally. Shunted to ground by 10 μ F capacitor.
TB9	Confirm Output	Low when forward power exceeds the users confirm set point	Active low. Pulled up to 5V by 4.7k. Will sink 1.5A and source 1mA.
TB10	Active Forward Monitor Input (Carrier On)	Indicates to the Wattcher that the RF is on and that forward power should be monitored for a low condition. There is an adjustable internal delay on the leading edge of this signal.	TTL levels, active low. Pulled up to 5V by 4.7k.

Active Forward Monitor (AFM) Input

Wiring concept examples for activating the AFM circuit are shown below. These can be used for remote onsite or offsite manual or automatic activation.

Dry Contact Closure

Closure will be from terminal 10 to case ground, terminal 7, in any convenient form, e.g. by an extra set of manual contacts on the transmitter keying relay or a separate remote switch.

Figure 12 Dry Contact Closure

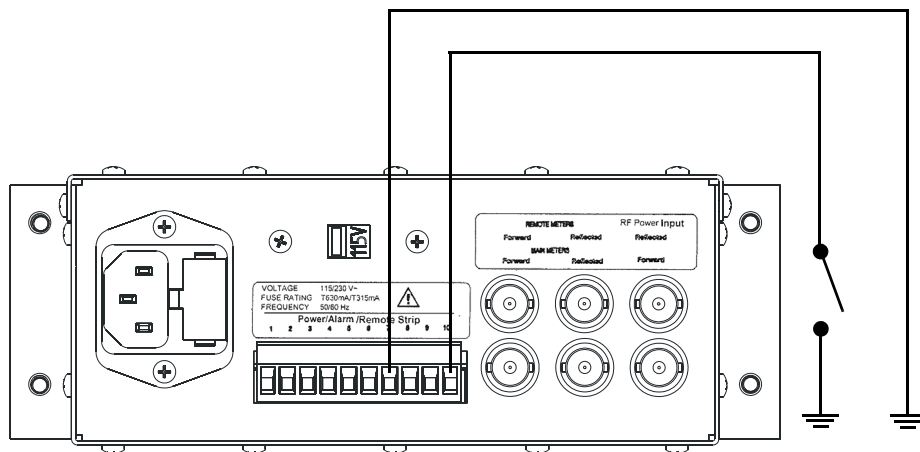

Logic "1" Closure

Closure circuit shown is a simplified means of interfacing a logic "1" as required from TTL driving positive signal, indicating transmitter is on.

Figure 13 Logic "1" Closure

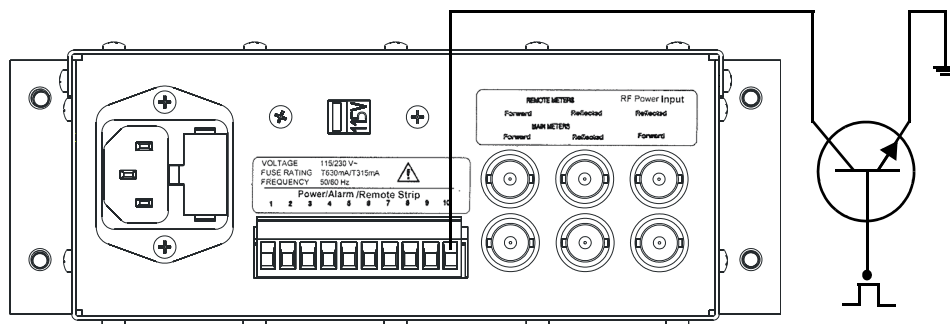

Confirm Output

For visual confirmation of transmitter “ON” see circuit below.

Relay Control

Relay control for greater current requirements. Connect the external relay coil, noting the polarity to terminal 5 for +5V output and to terminal 9. Confirm output.

Figure 14 Confirm Output Relay Control

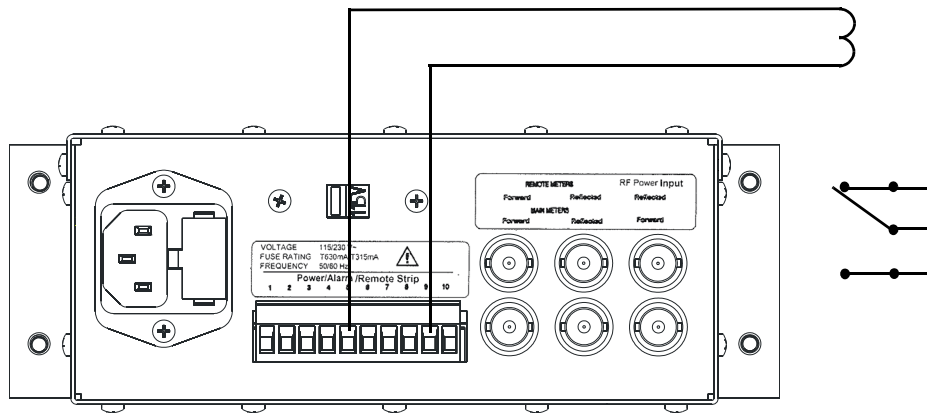

LED Indicator

Simple local or remote light emitting diode indicator, that requires no more than 1.5A. Resistors value may vary based on current requirements of chosen LED.

Figure 15 Confirm Output LED Indicator

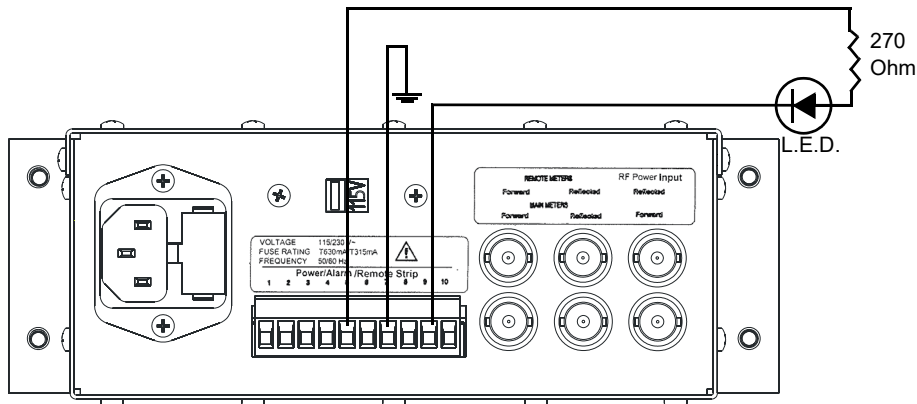

Reset Input

A remote reset could be used in case of false alarm or a brief disturbance has tripped the Wattcher Monitor but left the transmission intact.

Remote Contact Reset

This option allows reset onsite, but remote from the Wattcher unit. Terminal 8, Reset, is active low and will cause a reset when the switch is closed, making a connection to terminal 7, ground.

One or several momentary contact, normally open, switches can be connected in series for reset from various locations.

Figure 16 *Reset Input*

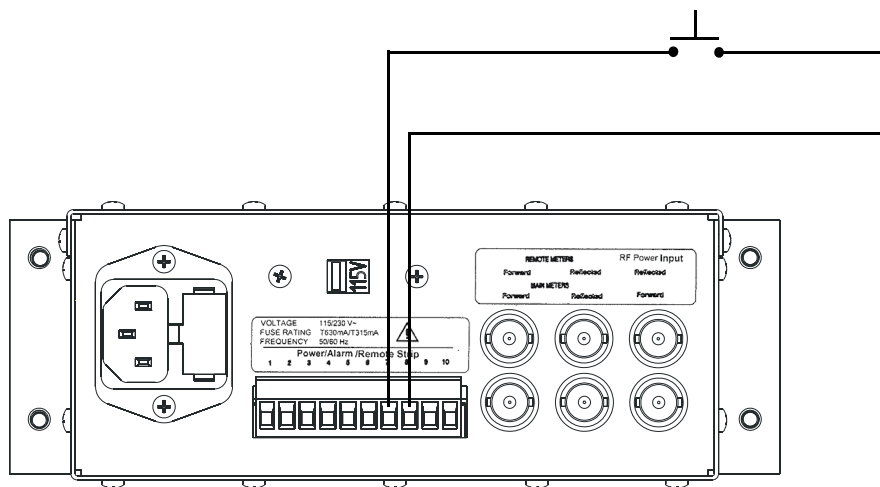

Remote Metering

Any number of meter pairs can be driven by the meter amplifiers up to 1mA into a total load of 470 to 1400 ohms, with out effecting scale shape. Long line losses are compensated by adjusting amplifier gain and full scale meter current after network is balanced and amplifier zero setting. Usually RFI prevention by shielding, using chokes and by-pass capacitors, is necessary only near the Watcher unit.

Figure 17 Remote Monitors and Meters

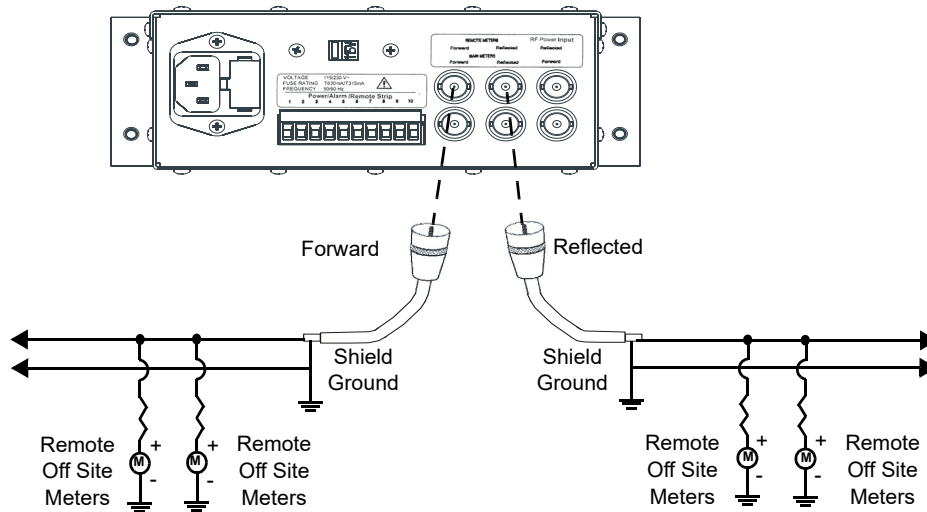

DC Power Supply Connections

A DC power supply can be connected to allow for mobile operation of the Watcher unit.

The positive terminal of the DC power supply must be connected to Terminal 1. The negative terminal must be connected to terminal 2. The minimum DC voltage required for operation is +12.7Vdc. The maximum DC voltage allowable is +16Vdc. The maximum current draw for this range is 400mA.

Figure 18 DC Power Supply

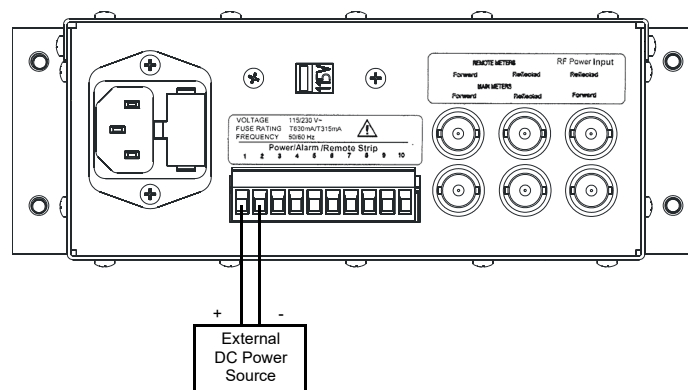

Limited Warranty

All products manufactured by Seller are warranted to be free from defects in material and workmanship for a period of one (1) year, unless otherwise specified, from date of shipment and to conform to applicable specifications, drawings, blueprints and/or samples. Seller's sole obligation under these warranties shall be to issue credit, repair or replace any item or part thereof which is proved to be other than as warranted; no allowance shall be made for any labor charges of Buyer for replacement of parts, adjustment or repairs, or any other work, unless such charges are authorized in advance by Seller.

If Seller's products are claimed to be defective in material or workmanship or not to conform to specifications, drawings, blueprints and/or samples, Seller shall, upon prompt notice thereof, either examine the products where they are located or issue shipping instructions for return to Seller (transportation charges prepaid by Buyer). In the event any of our products are proved to be other than as warranted, transportation costs (cheapest way) to and from Seller's plant, will be borne by Seller and reimbursement or credit will be made for amounts so expended by Buyer. Every such claim for breach of these warranties shall be deemed to be waived by Buyer unless made in writing within ten days from the date of discovery of the defect.

The above warranties shall not extend to any products or parts thereof which have been subjected to any misuse or neglect, damaged by accident, rendered defective by reason of improper installation or by the performance of repairs or alterations outside of our plant, and shall not apply to any goods or parts thereof furnished by Buyer or acquired from others at Buyer's request and/or to Buyer's specifications. Routine (regularly required) calibration is not covered under this limited warranty. In addition, Seller's warranties do not extend to the failure of tubes, transistors, fuses and batteries, or to other equipment and parts manufactured by others except to the extent of the original manufacturer's warranty to Seller.

The obligations under the foregoing warranties are limited to the precise terms thereof. These warranties provide exclusive remedies, expressly in lieu of all other remedies including claims for special or consequential damages. SELLER NEITHER MAKES NOR ASSUMES ANY OTHER WARRANTY WHATSOEVER, WHETHER EXPRESS, STATUTORY, OR IMPLIED, INCLUDING WARRANTIES OF MERCHANTABILITY AND FITNESS, AND NO PERSON IS AUTHORIZED TO ASSUME FOR SELLER ANY OBLIGATION OR LIABILITY NOT STRICTLY IN ACCORDANCE WITH THE FOREGOING.

