



# Test & Measurement Equipment Catalog





For over eight decades, Bird has been at the forefront of radio frequency (RF) measurement technology, ever since the revolutionary RF wattmeter debut by J. Raymond Bird in the 1940s.

As we surpass our 80th year, we remain committed to leading the industry, evolving alongside the dynamic RF test and measurement field. Our latest innovations, showcased at the beginning of this catalog, have been developed with ingenuity, precision, and simplicity to address the growing demands of the RF test and measurement industry.



**1942**

Slotted line used to develop Bird's very first terminating wattmeter, the **TS-70**.



**1952**

Oil and water-cooled load families expand



**1978**

Pushing the accuracy bar to 3% with the new 4421 power meter.



**1998**

Wideband sensors easily measure complex waveforms from digital TV, cellular and radio



**2019**

**Bird Engineering Company** was founded in 1942 by J. Raymond Bird

**1948**



Bird introduced the standard on which all future wattmeters would be judged – the **Model 43 Thruline Wattmeter**.

**1960's**



World's first microprocessor controlled Model 4381 directional wattmeter

**1986**



First handheld antenna & cable tester simplifies RF testing

**2000's**



0.5% precision pulse & CW sensors push the accuracy envelope for Semiconductor



# Contents



## RF ANALYZERS

SiteHawk™ Cable & Antenna Analyzer.....	14
SignalHawk™ Spectrum Analyzer.....	15
Master RF Test Kits .....	16
FlightHawk™ Aviation Cable & Antenna Analyzer Kits.	18
RailHawk™ Railway Cable & Antenna Analyzer Kit ...	19

## PRECISION RF PRODUCTS

Multifunction Power Meter .....	23
RF Power Sensors .....	24
Bird Diagnostic System .....	30
Calibration Carts.....	32
RF Calibration Kit .....	37

## RF POWER SENSORS

RF Power Meter Display .....	41
Wideband Power Sensors.....	42
Basic Power Sensors.....	44
Statistical Power Sensor .....	45
Directional Power Sensors .....	46

## RF POWER MONITORS

Channel Power Monitors .....	51
Broadcast Power Monitor.....	54
RF Monitors & Alarms .....	56

## RF POWER METERS

Portable Wattmeters .....	60
Panel Mount Wattmeters .....	66
Rigid Line Sections.....	68
Field Replacement Meter.....	69
Plug-In Elements.....	70

## RF LOADS & ATTENUATORS

Conduction-Cooled Loads.....	81
Convection-Cooled Loads .....	82
Oil-Cooled Loads .....	84
Market Specific Oil Loads.....	86
Water-Cooled Loads.....	87
Digital Air-Cooled Loads.....	88
Moduloads .....	90
Oil Convection-Cooled Attenuators .....	91
Convection-Cooled Attenuators.....	92

## ACCESSORIES

Passive Components .....	95
Variable RF Signal Samplers.....	100
Coaxial Selector Switches.....	101
QC Connectors .....	102
Adapters & Connectors.....	103
RF Connector & Adapter Kits .....	104
Protective Cases .....	107
Coaxial Cables .....	108
Load & Cooling Accessories .....	109

## SOFTWARE

RF Meter App.....	111
Virtual RF Meter Software (VPM3) .....	111
Windows®10 RF Meter App .....	112

## INDEX

Index .....	113
-------------	-----

# Discover RF with Bird

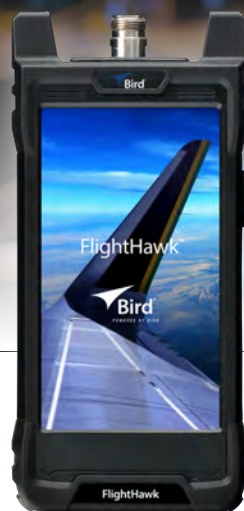

## SignalHawk™ Spectrum Analyzers

### SH-75S-AOA, SH-75S-TC

- SH-75S-AOA combines digital maps, GPS, and signal vectoring for enhanced tracking and awareness.
- SH-75S-TC tests comprehensive signals up to 7.5 GHz.
- Predefined measurements scan and discover spectrum events other analyzers miss.
- View the spectrum with trace display, spectrogram display, or both.

→ [Page 15](#)

## FlightHawk™ Aviation Cable & Antenna Analyzer Kits

### FH-AV-KIT, FH-AV-BASIC

- Locate opens, shorts, improper crimps, bends, moisture, loose connectors, and defective antenna elements that lead to weak or intermittent RF operations.
- Utilize the FDR technology to perform a VSWR test by transmitting a continuous RF sweep of the cables & antenna at their operating frequencies.
- Easy to use handheld tester, enabling the user to configure a Go/No-Go test by using the Pass/Fail, Limit Line, and Marker tools. This option can be used for a Measure/Match or Distance to Fault sweep.

→ [Page 18](#)

## Multifunction Power Meter with Dual Sensor Inputs

### 4421A

- Compatible with the full line of Bird's 402x-Series power sensors
- Automatic sensor detection for seamless integration
- Large 9.7 in full color LCD touchscreen display for easy readability
- Dual sensor option expands measurement capabilities
- Compact, lightweight and portable design enhances functionality

→ [Page 23](#)





## Precision RF Sensors for Semiconductor Applications

### 7027 & 7037 SERIES

- Capable of  $\pm 0.5\%$  and  $\pm 1\%$  power measurement accuracy
- Measure pulse state widths down to 1 $\mu$ s (sensor dependent)
- Measure pulse rep. rates from 10 Hz up to 100 kHz
- Gated power measurements with up to four sets of gates available
- Time domain display
- Automate with SCPI command set
- Harmonic filtering
- External sync input
- NIST traceable calibration

→ [Page 24 - 25](#)



## Ethernet Power Sensors

### 4042E & 4043E SERIES

- Remote monitoring of radio communication systems
- Ethernet, webserver, SNMP
- Measure total RMS power of all signals
- Measure select frequencies, up to 16 channels
- Selectable frequency and bandwidth for each channel
- Alarming on VSWR, low & high power

→ [Page 53](#)



## RF Power Meter Display

### 5000-NG

- Rugged, 8" color touch screen display for worry-free field use
- Automatic sensor detection that works with 10 supported Bird field USB sensors
- 48 hours of battery life for extended use
- 5.0 Megapixel camera to document equipment serial numbers and model number for warranty documentation and installation validation
- Tried and true power measurement with simple set-up
- Data logging, numerical & graphics display
- Easy data transfer via USB or WiFi

→ [Page 41](#)

# SERVICES

## Expertise, Support, and Traceability With the Bird Service Center

The Bird Service Center located in Solon, Ohio is an A2LA Accredited Laboratory which provides RF calibration, repair and support services. With years of combined experience, our skilled technicians and product experts offer reliable service and customer care. Our worldwide network of service centers and service partners provide the best solution for maintaining the high level of performance, calibration, and RF repair for all of your Bird products.



**REPAIR & CALIBRATION**

Page 7



**RF TRAINING & CERTIFICATION**

Page 8



**RF TECHNICAL SUPPORT**

Page 8



**EXTENDED WARRANTIES**

Page 8





# Repair & Calibration Services

Restore your instrument or equipment to original functionality, specifications and like-new condition, every time. Our worldwide service centers are staffed by experienced technicians, and use factory diagnostic methods, test fixtures, test and verification software, firmware upgrades, and service notes to ensure you get the most of your test budget.

All repair work includes any calibration and adjustments necessary to restore your equipment to published accuracy specifications, ensuring that all measurements can be trusted.

## Calibration Options

Bird provides different calibration service levels depending on your requirements. Standard and accredited calibration services provide the traceability needed for regulatory requirements.

### 1 STANDARD CALIBRATION (ANSI/NCSL Z540.1)

This service provides a calibration certificate with a calibration date and a recommended calibration due date. A traceability statement is provided. As-Found and As-Left condition statements (i.e. in-tolerance or out-of-tolerance) are included.

### 2 STANDARD CALIBRATION (ANSI/NCSL Z540.1) WITH TEST REPORT

This service provides a calibration certificate with a calibration date and a recommended calibration due date. A traceability statement is provided. As-Found and As-Left measurement data and respective limits for each parameter tested during the calibration is provided. Measurement parameters not meeting the test specifications (out-of-tolerance) are identified and reported on the certificate. Product measurement uncertainties are available upon request. Additional charge will apply.

### 3 17025 ACCREDITED CALIBRATION WITH TEST REPORT

Instrumentation is calibrated in accordance with ISO/IEC 17025 within our approved scope of accreditation. Accredited calibrations provide a certificate of calibration with the accrediting body's logo on the document. This service provides a calibration certificate with a calibration date on the certificate and the recommended calibration due date. A traceability statement is provided. As-Found and as-Left measurement data and respective limits for each parameter tested during the calibration is provided. Measurement parameters not meeting the test specifications (out-of-tolerance) are identified and reported on the certificate. Product measurement uncertainties are available upon request. Additional charge will apply.





## RF Training & Certification Services

Measurement challenges are increasing as standards and technologies constantly evolve. Build confidence and gain new skills to make accurate measurements through our Training and Certification services by Bird RF experts. E-Learning and Instructor-led courses enable you to build expertise in both technology and solutions. Instructor-led courses are customized to meet specific requirements and training can occur at your site.

### E-Learning

- Available 24/7, free web-based courses enable you to learn at your pace.
- Go in-depth in specific topics, skip those you know, or repeat topics.
- Boost your measurement and technology knowledge.

### Instructor-Led

- Customized courses to meet your specific requirements.
- Training can occur at your site using your equipment or ours.
- Certification available for select courses to demonstrate your mastery.



## RF Technical Support

At Bird, we help companies address their toughest RF measurement, system, or application. Our dedicated technical applications engineers are a phone call or email away to help solve your problem. For self-service support, search our technical support center on BirdRF.com for FAQs, documentation, product videos and more.



## Extended Warranties

Our factory warranty covers your equipment from failures and design flaws. Safeguard your investment and keep your Bird products running like new with an extension of the factory warranty.





# Detect. Analyze. Defeat.

Validate performance on the bench, in the chamber, or on the range with X-Com Systems RF data recorders, RF playback and signal editing and analysis software solutions. Designed to record modern waveforms, the X-COM Systems products can meet recording needs from HF to millimeter wavelengths in mission-critical applications.

RF INTERFERENCE ANALYSIS   ELECTRONIC WARFARE   SURVEILLANCE   SPECTRUM MANAGEMENT   FORENSICS   DESIGN VALIDATION



## **IQC91000A** **RF RECORD & PLAYBACK SYSTEM**

With its 12 bit fidelity, the IQC91000A can continuously record 90 minutes of 1000 MHz wide waveforms to ensure designers capture transient and unexpected events.



## **IQC5000B SERIES** **RF RECORD & PLAYBACK SYSTEM**

The IQC5000B series is the smallest, lightest, best-performing system available for the capture and replay of RF and microwave signals. Up to 255 MHz of record and playback bandwidth per channel, the IQC5000B can meet recording needs from HF to millimeter wavelengths in mission-critical applications.

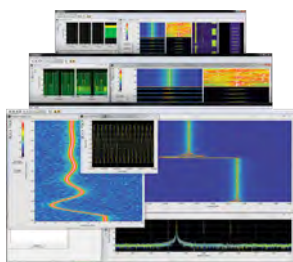

## **SPECTRO-X** **RF SIGNAL ANALYSIS TOOLKIT**

Spectro-X is the essential signal extraction tool that enables users to sift through multi-terabytes of RF data recordings to quickly identify signals of interest. The fast, spectral search enables visualization and analysis, with high resolution, for system or test engineers.

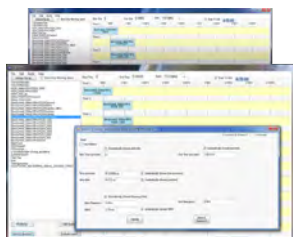

## **RF EDITOR** **RF SIGNAL EDITOR SOFTWARE TOOLKIT**

RF Editor is a drag-and drop graphical editing tool that easily modifies I&Q signals of any length and creates entirely new ones. Modify and build signal waveforms in the time and frequency domains, make frequency domain signal modifications and move any signal or slice of spectrum anywhere among 10 time-domain tracks in the recording.

LEARN MORE ABOUT X-COM SYSTEMS OFF AIR SOLUTIONS  
[birdrf.com/AboutUs/X-Com systems](http://birdrf.com/AboutUs/X-Com%20systems)



# RF ANALYZERS

## Measure with Confidence and Withstand Your Toughest Working Environments

Install and maintain wireless systems, perform in-depth troubleshooting, conduct routine maintenance and ensure your team's preparedness with Bird's portable RF analyzers. The rugged, hand-held equipment is not only used to maintain communication systems, but to also verify field performance with our Spectrum Analyzers, and identify and locate faults in the transmission system with our SiteHawk series of Cable and Antenna test equipment.



CABLE & ANTENNA ANALYZERS

Page 14



SPECTRUM ANALYZERS

Page 15



MASTER TEST KITS

Page 16 - 17



CABLE & ANTENNA KITS

Page 18 - 19





# Cable & Antenna Analyzers

The SiteHawk series has been the preferred choice for installers, contractors and service providers for troubleshooting antenna and RF feedlines. Utilizing built-in measurement capabilities including precision return loss, VSWR, distance-to-fault and insertion loss, novice and expert technicians can perform testing for applications such as LMR, avionics, railway, cellular, and industrial communication systems to name a few.

## 1 WHAT DOES A CABLE AND ANTENNA ANALYZER DO?

- Assess the health of antenna and cable systems without the need for RF power
- Provides an operational baseline during antenna site commissioning
- Tests the overall integrity of the antenna system installation
- Verifies antenna system components meet manufacturer's design specification
- Pinpoints the location of the antenna systems faults prior to usage

## 2 WHO NEEDS A CABLE AND ANTENNA ANALYZER?

Anyone who is working on a cable and antenna RF system and needs to troubleshoot the common causes of Signal Reflections: Land Mobile Radio, Public Safety, Semiconductor, Wireless, Cellular and Broadcast, Military & Government, Medical, Aviation, Marine, Amateur Radio and Automotive.

Utilized for commissioning, maintenance and fault-finding of ground-to-air radios, airborne radios, repeaters, antennas, antenna combiners and transmission cables. Locate opens, shorts, improper crimps, bends, moisture, loose connectors, and defective antenna elements that lead to weak or intermittent RF operations. Common causes include:

- **Cable problems** - Open, shorted, dented, kinked, crimped, deformed, bullet hole, over tightened ground kit, over tightened clamp, water intrusion, improper bend radius
- **Connector problems** - Poor quality, improperly installed, improper center pin depth, corroded, water intrusion
- **Defective Antenna** - Improperly mounted, UV damage, damage from icing, lightning damaged, wrong frequency range

## 3 WHAT ARE THE KEY TYPES OF MEASUREMENTS?

**FDR (Frequency Domain Reflectometry)** measurement method results in a highly reliable assessment of the health of critical components in your system; ultimately providing a "heads-up" before a failure occurs. An FDR tests and verifies the antennas and cables in your RF system individually, or as a complete system.

**VSWR** is an abbreviation for Voltage Standing Wave Ratio and is a measurement of how well the components in a system match impedance. VSWR is expressed as a ratio without units.

**Return Loss** is the ratio of the maximum forward power in a transmission line to the power reflected back to the source. It is the power produced by a transmitter that is reflected back to the transmitter that could result in damage to the transmitter and does not add to the carrier's signal. Expressed in decibels, it is a measurement of how well systems components "match".

**Insertion Loss** is also known as cable loss and is the signal power lost within the feed line itself, including signal loss at joints, connectors, transitions, adapters, etc. Insertion loss takes place in one direction in a feed line and is the amount "lost" between the input end of a cable and the output connector of the same cable or system. Insertion loss is measured in dB.

**Distance to Fault (DTF)** is a measurement of how far from the test point a fault occurs. Instead of "hand-over-hand" checking of the feed line up a tower, the device will give a distance to the problem.



# Spectrum Analyzers

With the expansion of wireless communications, spectrum analyzers like the Bird SignalHawk, are an essential part of the RF tool kit and are increasingly critical. Although traditionally stand-alone bench top test equipment, our handheld spectrum analyzers are ready for any field application.

## 1 WHAT IS A SPECTRUM ANALYZER?

Spectrum analyzers are designed for use in the installation and maintenance of Radio Frequency (RF) and wireless systems. They are important pieces of instrumentation to test radio frequency circuits and systems and provide effective insight into RF performance of a system, circuit, or module. This information provides detailed measurements about the spectrum of a signal. Signals of different frequencies and complex waveforms can be displayed to determine if they are falling within the required limits within the specified frequency.

## 2 HOW ARE SPECTRUM ANALYZERS USED?

When looking at the frequency spectrum of a signal you can see the following:

- The overall spectrum of a modulated signal which determines if the signal is too wide or narrow and causing interference
- Any unwanted or illegitimate signal that would cause interference to users on other frequencies when transmitted
- Determine if a signal is on the correct frequency and not in another band
- Power, frequencies, and phase noise in a signal
- Frequencies and the nature of a signal that may be causing an issue





### 3 SPECTRUM ANALYZER MEASUREMENTS

Bird's spectrum analyzers provide the user with quick predefined measurements for field use. This is very useful for field service applications where radio or wireless transmissions or other radio frequencies signals need to be monitored and the spectrum needs to be checked. Here are some key measurements you can perform with our analyzers.

**Channel Power Measurement** measures the Integration Bandwidth, the total power over a frequency range, concentrated on the center frequency of the sweep. It is useful for channelized (frequency-division multiplexed) signals. Results are shown in both total power in the channel (in dBm or Watts), and spectral density (dBm or W per Hz).

**Adjacent Channel Power Ratio (ACPR)** measures the relative power of frequency bands adjacent to a central channel. This is often used to identify power leakage from the center channel into the adjacent channels. The total power in the center (main) channel is displayed in dBm and the power in the adjacent channels (Lower and Upper) are given in dBc and dBm.

**Phase Noise** is signal fluctuations appearing as noise spreading out above and below the carrier. High Phase noise can reduce signal quality possibly increasing the communications link's error rate.

**Occupied Bandwidth (OBW)** measures the frequency band bandwidth that contains a specified percentage of the total power of the signal. It gives best results with single-peaked signals. Bandwidth measurement results are in Hz units.

**N dB Measurement** measures the frequency bandwidth at a user selected value in decibels below the signal peak. Bandwidth measurement results are in Hz units.

**Field Strength** measurement can be used to measure a single frequency (point) or a band of frequencies (the full span set on the SignalHawk), measurement results are in mV/m units. Field strength measurements are typically used to determine the amount of RF radiation emitted by electronic equipment.

**FM Demodulation** measurement may be used to demodulate a signal in the FM spectrum. When an FM signal of interest is tuned as the center frequency, the demodulated signal may be listened to through the SignalHawk's speakers or recorded (.wav) for playback later.

**GNSS Signal Quality** measurement is used to analyze Global Navigation Satellite System (GNSS (GPS, BeiDou)) signal quality through Carrier-to-Noise Ratio (CNR) Loss and Jammer-to-Noise Ratio (JNR).

**Spectrum Masking** allows limit lines to be placed on the display. Multiple limit lines may be added creating elaborate mask around signals of interest.

### 4 WHAT IS ANGLE OF ARRIVAL (AOA)?

AOA stands for "Angle of Arrival", also known as automatic direction finding and is an added software feature in the SH-60S-AOA. Using a technique called Triangulation, a signal strength sample is recorded in different locations, and the position is marked on a map, forming a triangle.

- AOA is the direction from which an RF Signal is received and is used to discover the location of an interfering signal, such as an unlicensed radio transmission, or other types of generators, producing RF signals disrupting lawful transmissions
- AOA measurement locates and senses the direction of the arriving transmitting signal, then calculates the relative orientation or angle
- Triangulation is when three or more measurements cross, identifying the location of the unknown signal

### 5 WHAT ARE SOME APPLICATIONS OF AOA?

When identifying situations that require AOA functionality, there are some common interfering sources:

- Faulty or poorly shielded electronic devices that allow energy to leak and interfere with other RF devices by creating inadvertent transmissions that broadcast in unknown locations, frequencies, and times.
- Incorrectly configured electronic devices
- Electronic devices that are not compliant with local regulations
- Jammers and deliberate interference





## SiteHawk™ Cable & Antenna Analyzers

### SK-4500-TC, SK-6000-TC, SK-9000-TC

Save critical time, components, and money by eliminating time swapping out components until you find and locate the issue. Discontinuities can be a real problem and cause significant reflections by damaged cables, loose or improperly installed connectors, and environmental factors. With Bird's SiteHawk™, find the exact location of the problem over a wide frequency range - from 1 MHz to 9000 MHz using Distance to Fault, return loss and cable loss measurements techniques.

#### MEASUREMENT

<b>Frequency Range</b>	SK-4500-TC 1 MHz to 4500 MHz
	SK-6000-TC 1 MHz to 6000 MHz
	SK-9000-TC 1 MHz to 9000 MHz
<b>Frequency Resolution</b>	1 kHz
<b>Output Power</b>	-10 dBm, typical
<b>Trace Noise Magnitude (IFBW 1kHz)</b>	0.05 dB rms
<b>Measurement Speed</b>	1 ms/data point
<b>Measurement Points</b>	51 to 3201
<b>Measure Bandwidth</b>	100 Hz to 30 kHz
<b>Temperature Stability</b>	0.01 dB/°F (0.02 dB/°C)
<b>Return Loss Measurement Range</b>	0 dB to -60 dB
<b>Resolution</b>	0.01 dB
<b>VSWR Measurement Range</b>	1.0 to 65.0
<b>Cable Loss Measurement Range</b>	0 dB to 30 dB
<b>DTF Range</b>	0 to 5000 ft (0 to 1500 m)
<b>Corrected Directivity</b>	>38 dB
<b>Maximum Input Voltage</b>	50 V
<b>Immunity to Interfering Signals</b>	+13 dBm
<b>Power Measurement</b>	Yes

#### ACCURACY

<b>Frequency Accuracy</b>	±2.5 ppm @25 °C
<b>Reflect Amplitude Accuracy</b>	-10 dB to 0 dB: ±0.6 dB
	-20 dB to -10 dB: ±0.8 dB
SK-4500-TC & SK-6000-TC	-35 dB to -20 dB: ±3.0 dB
<b>Reflect Amplitude Accuracy</b>	-10 dB to 0 dB: ±0.6 dB
	-25 dB to -10 dB: ±1.5 dB
SK-9000-TC	-35 dB to -25 dB: ±4.0 dB

#### SYSTEM

<b>Display</b>	5.5 in, 1920 x 1080 p
<b>Languages</b>	English, Chinese, Spanish
<b>Battery Type</b>	Lithium-ion rechargeable
<b>Battery Operating Time</b>	10 hours typical
<b>Battery Charge Time</b>	5 hours typical
<b>Storage Capacity</b>	Thousands of trace and setups
<b>Recommended Calibration Interval</b>	3 years

#### CONNECTORS

<b>Connector</b>	USB Type-C, USB 3.0
<b>Test Port Connector Impedance</b>	N-type, Female 50 Ohms

#### ENVIRONMENTAL

<b>Operating Temperature</b>	14 °F to 131 °F (-10 °C to +55 °C)
<b>Storage Temperature</b>	-40 °F to 176 °F (-40 °C to +80 °C)
<b>Battery Charging Temperature</b>	32 °F to 95 °F (0 °C to +35 °C)

#### PHYSICAL

<b>Size</b>	7.7 in x 3.6 in x 2.4 in (195 mm x 90 mm x 60 mm)
<b>Weight</b>	1.98 lb (0.9 kg)

#### CERTIFICATIONS

<b>CE</b>	EMC: Standard EN 61326-1:2006
-----------	-------------------------------

#### PRODUCT FEATURES

- Locate RF cable, connector, and antenna problems at the source
- Test RF cables and antennas at the frequency of operation
- Fault location or DTF mode plots VSWR or Return Loss levels at each distance point along the cable and antenna system length
- Cable Loss function measures insertion loss of the cable system over a given frequency range
- Use FDR (Frequency Domain Reflectometry) measurement methods that will result in a highly reliable assessment of the health of critical components in your system; ultimately providing a "heads-up" before a failure occurs
- Single-port cable loss measurement

#### APPLICATIONS

- Cellular Networks 3G, 5G (2.4, 4.2 GHz & 600, 850 MHz), PCS/DCS, CDMA, GSM and LTE Protocols, Broadcast, Paging, Government, Tactical Military, Microwave, Public Safety, Trunking, TETRA, Network Coverage WLAN, WLL (802.11), Semiconductor calibration load/RF cable test
- C-Band (4 to 8GHz) satellite communications and some X-Band radar frequency sub-bands with SK-9000-TC

#### COMPATIBLE WITH

- Basic, Wideband, and Statistical Power Sensors
- Bird RF Meter App





## SignalHawk™ Spectrum Analyzers

### SH-60S-AOA, SH-60S-TC, SH-75S-AOA, SH-75S-TC

The SignalHawk™ family of handheld spectrum analyzers brings you the best in class functionality in a compact, portable, and affordable package. With an intuitive touchscreen user interface, you can unlock your potential and get the most out of your work. Our powerful spectrum analyzers help you detect, identify, and resolve interference issues quickly and accurately.

#### MEASUREMENT

<b>Data Display</b>	
SH-60S-AOA, SH-75S-AOA	Triangulated location on map
SH-60S-TC, SH-75S-TC	Waterfall
<b>Frequency Range</b>	
SH-60S-AOA, SH-60S-TC	9 kHz to 6 GHz
SH-75S-AOA, SH-75S-TC	9 kHz to 7.5 GHz
<b>Aging</b>	±1 ppm
<b>Sweep Time</b>	
SH-60S-AOA, SH-60S-TC	1.1 ms to 1600 s full span, 2.69 ms to 1600 s settable zero span
SH-75S-AOA, SH-75S-TC	1.2 ms to 1600 s full span, 3.99 ms to 1600 s settable zero span
<b>Resolution Bandwidth</b>	10 Hz to 5 MHz in 1, 2, 3, 5, 10 steps
<b>Second Harmonic Distortion</b>	1.6 GHz to 70 dBc
<b>Third Order Intercept (TOI)</b>	+15 dBm (-10 dBm tones, 1 MHz apart, preamp off, reference level -10 dBm)
<b>P1dB</b>	
SH-60S-AOA, SH-60S-TC	+5 dBm nominal
SH-75S-AOA, SH-75S-TC	0 dBm nominal
<b>Phase Noise</b>	
	-95 dBc/Hz, @10 kHz (typical -97 dBc/Hz)
	-115 dBc/Hz, @1 MHz (typical -116 dBc/Hz)
<b>Measurement Range</b>	DANL to +20 dBm
<b>Input Attenuator Range</b>	0 to 30 dB, 1 dB step

<b>Input Attenuator Uncertainty</b>	±0.6 dB
<b>Display Average Noise Level (DANL)</b>	
	<b>Preamp Off:</b> 1 GHz, -129 dBm/Hz (typical -132 dBm/Hz)
	<b>Preamp +20 dB:</b> 1 GHz, -149 dBm/Hz (typical -152 dBm/Hz)
	<b>Preamp +40 dB:</b> 1 GHz, -168 dBm/Hz (typical -169 dBm/Hz)
	(Input terminated, detector set to positive, trace average set to 1000, span set to 50 kHz, reference level of -100 dBm, all other settings auto-coupled, 23±5 °C normalized to 1 Hz RBW)
<b>Residual Responses</b>	
SH-60S-AOA, SH-60S-TC	-75 dBm
SH-75S-AOA, SH-75S-TC	-60 dBm
<b>Max Safe Input Level</b>	
	<b>Preamp Off:</b> +30 dBm
	<b>Preamp +20 dB:</b> 0 dBm
	<b>Preamp +40 dB:</b> -20 dBm
<b>Reference Level Range</b>	-140 dBm to +20 dBm, -190 dBm to +70 dBm (Ref level offset: ON)
<b>RBW Switching Uncertainty</b>	±0.3 dB
<b>CONNECTORS</b>	
<b>RF In</b>	N(f)
<b>USB</b>	USB type C
<b>Power Interface</b>	Slim tip, DC 20 V

#### PRODUCT FEATURES

- Leverages OpenStreetMap mapping technology from allowing users to triangulate the source
- Spectrogram/Waterfall display shows intermittent power levels at a glance
- View the spectrum with trace display, spectrogram display, or both
- More than 2x faster sweep times than the competition
- High-resolution, full-color display for indoor/outdoor, and multi-screen viewing
- Rugged and weather resistant

#### PREDEFINED MEASUREMENTS

- Channel Power
- Adjacent Channel Power Ratio (ACPR)
- Phase Noise
- N dB Down Bandwidth
- Occupied Bandwidth (OBW)
- Field Strength
- FM Demodulation
- CNR Loss (GNSS Signal Quality)
- Spectrum Masking and Limit Lines
- Gate Scanning with SH-75S series

#### COMPATIBLE WITH

- Basic, Wideband, and Statistical Power Sensors
- Bird RF Meter App
- ANT Series, Field Strength Antennas

#### ACCURACY

<b>Frequency Span Accuracy</b>	±1%
<b>RBW Accuracy</b>	≥1 MHz, ±10%, <1 MHz, ±2%
<b>Amplitude Accuracy</b>	±1.5 dB (ATT set to 0 dB, input signal -5 to -30 dBm, detector set to positive, sensitivity set to low, RBW auto-coupled, all other settings auto-coupled, 23±5 °C. Half hour warm-up required.)
<b>Reference Level Accuracy</b>	≥-60 dBm, ±0.8 dB

#### SYSTEM

<b>Display</b>	5.5 in, 1280 *720p
<b>OS</b>	Android
<b>Languages</b>	English, Chinese
<b>Battery Type</b>	Lithium-ion rechargeable
<b>Battery Operating Time</b>	5 hours typical
<b>Battery Charge Time</b>	6 hours typical

#### ENVIRONMENTAL

<b>Operating Temp</b>	0 °C to 50 °C
<b>Storage Temp</b>	-20 °C to 70 °C

#### PHYSICAL

<b>Size</b>	7.8 in x 3.7 in x 2.4 in (197 mm x 93 mm x 61 mm)
<b>Weight</b>	1.98 lb (0.9 kg)



### CABLE & ANTENNA ANALYZER FEATURES

- Wide frequency range from 1 MHz to 6 GHz
- Test RF cables and antennas at the frequency of operation
- Distance to Fault, return loss, cable loss
- Frequency domain reflectometry
- RF Power Measurement Support with RF Meter App and Bird's USB Wideband Power Sensors through OTG USB communication port

### SPECTRUM ANALYZER FEATURES

- Wide frequency range between 9 kHz to 6 GHz providing real-time spectrum monitoring and analysis of RF frequency circuits
- Predefined Measurements: Channel Power, ACPR, OBW, Phase Noise, N dB Down Bandwidth, Field Strength, FM Demodulation and more
- View the spectrum with trace display, spectrogram display, or both

### KITS INCLUDE

## Master RF Test Kits

### SK-SH-KIT

Bird's Master RF Test Kit combines the best in Bird test & measurement equipment for field technicians and engineers to install, analyze, troubleshoot, and maintain both coaxial and antenna systems

This Master RF Test kit provides all the necessary equipment needed including the Bird SiteHawk™ Cable and Antenna Analyzer and SignalHawk™ Spectrum Analyzer, wideband power sensor, calibration combo, adapter kit, termination/load and cables all housed in a hard shell, organized case.

Bird's rugged and reliable test & measurement equipment provides all the coverage you need for any cable & antenna installation or maintenance as well as interference analysis of cellular systems, land mobile radio systems and Wi-Fi.

This kit is ideal for wireless service providers, contractors, military, aerospace and defense, and public safety applications.



SK-6000-TC  
CABLE & ANTENNA  
ANALYZER

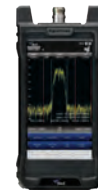

SH-60S-TC  
SPECTRUM  
ANALYZER



5017D-AV  
POWER SENSOR



SK-CAL-MN-C6  
CALIBRATION  
COMBO



FH-AV-CC  
HARD CARRYING  
CASE



4240-401  
ADAPTER KIT

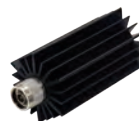

25-T-MN  
TERMINATION/LOAD  
RESISTOR

### OPTIONAL KIT

- SK-SH-KITA is a Master RF Kit with SH-60S-AOA substituted for interference hunting.





## SiteHawk™ Test Kits

### 7003A001 SERIES

Bird's SiteHawk Test Kits provide all the necessary equipment needed to perform precise power measurements to quickly identify faulty antennas, cables, and connectors in order to resolve issues and return radio systems to service. Easily select your kit by frequency range and power range with a variety of combinations of sensors and analyzers for expanded capabilities.

Kits include either a Bird SiteHawk SK-4500-TC or SK-6000-TC Cable and Antenna Analyzer covering up to 6 GHz, calibration combo, adapter kit, termination/load, and cables all housed in a hard shell, organized case. Avoid the downtime and expense of trial-and-error component swapping to find and fix issues with the Bird® SiteHawk Test Kit.

### POWER SENSOR SELECTION GUIDE

MODEL	SENSOR	FREQUENCY RANGE	POWER RANGE
7003A001-5	None	N/A	N/A
7003A001-6	7020-1-010101	350 MHz to 4.0 GHz	150 mW to 150 W
7003A001-7	7020-1-030301*	25 MHz to 1.0 GHz	500 mW to 500 W
7003A001-8	5017D*	25 MHz to 1.0 GHz	500 mW to 500 W 1000 W Peak
7003A001-9	7022-1-020201	350 MHz to 4.2 GHz	150 mW to 150 W
7003A001-19	5019D	25 MHz to 1.0 GHz	100 mW to 100 W 260 W Peak

\*Derate maximum average power rating from 500 W at 300 MHz to 100 W at 1 GHz using a straight line on a log-log scale.

### PRODUCT FEATURES

- Determine if there is a problem with your cable and antenna system using the Measure Match function
- Locate the problem source with the Use Distance to Fault measurement
- Multiple models available utilizing Bird power sensors with varying frequency and power ranges in order to select the model best suited to the application

### KITS INCLUDE



SK-4500-TC or  
SK-6000-TC  
CABLE & ANTENNA  
ANALYZER



SK-CAL-MN-C6  
CALIBRATION  
COMBO



4240-401  
ADAPTER KIT

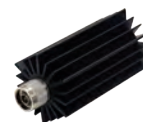

25-T-MN  
TERMINATION/LOAD  
RESISTOR



5000-035  
HARD CARRYING  
CASE



5A2970-16-120B  
10' RG142 CABLE

### SITEHAWK OPTION

- SK-6000-TC can be substituted for SK-4500-TC by adding -6 to the part number, e.g. 7003A001-5-6.



# FlightHawk™ Aviation Cable & Antenna Analyzer Kits

## FH-AV-KIT, FH-AV-BASIC

The basic kit, FH-AV-BASIC, provides all of the essential RF measurement capabilities required for installing and maintaining aircraft antenna systems. Ideal for identifying failing RF cables, connectors, antennas, and more.

The master kit, FH-AV-KIT, is a comprehensive solution that adds RF power measurement capabilities. Included are Bird's wideband power sensor, a 25 W compact load, and all necessary adapters and cables.

### MEASUREMENT

Frequency Range	1 MHz to 6000 MHz
Frequency Resolution	1 kHz
Output Power	-10 dBm, typical
Trace Noise Magnitude (IFBW 1kHz)	0.05 dB rms
Measurement Speed	1 ms/data point
Measurement Points	51 to 3201
Measure Bandwidth	100 Hz to 30 kHz
Temperature Stability	0.01 dB/°F (0.02 dB/°C)
Return Loss Measurement Range	0 dB to -60 dB
Resolution	0.01 dB
VSWR Measurement Range	1.0 to 65.0
Cable Loss Measurement Range	0 dB to 30 dB
DTF Range	0 to 5000 ft (0 to 1500 m)
Corrected Directivity	>38 dB
Maximum Input Voltage	50 V
Immunity to Interfering Signals	+13 dBm
Power Measurement	Yes

### ACCURACY

Frequency Accuracy	±2.5 ppm @25 °C
Reflect Amplitude Accuracy	<-10 dB to 0 dB: ±0.6 dB <-20 dB to -10 dB: ±0.8 dB -35 dB to -20 dB: ±3.0 dB

### SYSTEM

Display	5.5 in, 720p
Languages	English, Chinese, Spanish
Battery Type	Lithium-ion rechargeable
Battery Operating Time	10 hours typical
Battery Charge Time	5 hours typical
Storage Capacity	Thousands of trace and setups
Recommended Calibration Interval	2 years

**Compatible With** For a complete list of compatible sensors see Bird's RF Meter page <http://bit.ly/rfmeterrapp2>

### CONNECTORS

Connector	USB Type-C, USB 3.0
Test Port Connector Impedance	N-type, Female 50 Ohms

## PRODUCT FEATURES

- Locate opens, shorts, improper crimps, bends, moisture, loose connectors, and defective antenna elements that lead to weak or intermittent RF operations.
- Utilize the FDR technology to perform a VSWR test by transmitting a continuous RF sweep of the cables & antenna at their operating frequencies.
- Easy to use handheld tester, enabling the user to configure a Go/No-Go test by using the Pass/Fail, Limit Line, and Marker tools. This option can be used for a Measure/Match or Distance to Fault sweep.
- Identifies issues easily from the equipment rack, eliminating the need to disassemble the airplane to test the RF system.

## THE MASTER FH-AV-KIT INCLUDES



FLIGHTHAWK™



5017D-AV POWER SENSOR



SK-CAL-MN-C6 CALIBRATION COMBO



FH-AV-CC HARD CARRYING CASE



4240-401 ADAPTER KIT

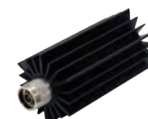

25-T-MN TERMINATION/LOAD RESISTOR

## THE FH-AV-BASIC INCLUDES



FLIGHTHAWK™



FH-AV-CC HARD CARRYING CASE

### PHYSICAL

Size	7.7 in x 3.6 in x 2.4 in (195 mm x 90 mm x 60 mm)
Weight	1.98 lb (0.9 kg)

### CERTIFICATIONS

CE	EMC: Standard EN 61326-1:2006
----	-------------------------------





## RailHawk™ Railway Cable & Antenna Analyzer Kit

### RH-RR-KIT

Bird's new Railway RF Cable & Antenna Analyzer solution provides a comprehensive kit that allows technicians to maintain high quality service networks in the railway industry. Based on the need for redundant communications, Bird's Cable & Antenna Analyzer increases reliability and assures maintainability for communication protocols targeted in railway space.

#### MEASUREMENT

Frequency Range	1 MHz to 6000 MHz
Frequency Resolution	1 kHz
Output Power	-10 dBm, typical
Trace Noise Magnitude (IFBW 1kHz)	0.05 dB rms
Measurement Speed	1 ms/data point
Measurement Points	51 to 3201
Measure Bandwidth	100 Hz to 30 kHz
Temperature Stability	0.01 dB/°F (0.02 dB/°C)
Return Loss Measurement Range	0 dB to -60 dB
Resolution	0.01 dB
VSWR Measurement Range	1.0 to 65.0
Cable Loss Measurement Range	0 dB to 30 dB
DTF Range	0 to 5000 ft (0 to 1500 m)
Corrected Directivity	>38 dB
Maximum Input Voltage	50 V
Immunity to Interfering Signals	+13 dBm
Power Measurement	Yes

#### ACCURACY

Frequency Accuracy	±2.5 ppm @25 °C
Reflect Amplitude Accuracy	<-10 dB to 0 dB: ±0.6 dB <-20 dB to -10 dB: ±0.8 dB -35 dB to -20 dB: ±3.0 dB
<b>SYSTEM</b>	
Display	5.5 in, 720p
OS	Android
Languages	English, Chinese, Spanish
Battery Type	Lithium-ion rechargeable
Battery Operating Time	10 hours typical
Battery Charge Time	5 hours typical
Storage Capacity	Thousands of trace and setups
Recommended Calibration Interval	2 years
Compatible With	Bird's RF Meter App utilizing RF compatible sensors 501X, 7020, 7022 Series

#### CONNECTORS

Connector	USB Type-C, USB 3.0
Test Port Connector Impedance	N-type, Female 50 Ohms

#### ENVIRONMENTAL

Operating Temperature	14 °F to 131 °F (-10 °C to 55 °C)
Storage Temperature	-40 °F to 176 °F (-40 °C to 80 °C)
Battery Charging Temperature	32 °F to 95 °F (0 °C to 35 °C)

#### PHYSICAL

Size	7.7 in x 3.6 in x 2.4 in (195 mm x 90 mm x 60 mm)
Weight	1.98 lb (0.9 kg)

#### CERTIFICATIONS

CE	EMC: Standard EN 61326-1:2006
----	-------------------------------

#### PRODUCT FEATURES

- Test RF cables & antennas at the frequency of operation, not at DC where problems are masked.
- Locate RF cable, connector & antenna problems at the source.
- FDR (Frequency Domain Reflectometry) pinpoints faults at the frequency of operation, unlike other measurement techniques which can mask pending failures of critical system components.
- Distance to Fault (DTF) mode can plot VSWR or Return Loss levels at each distance point along the cable and antenna system length.
- Cable Loss function measures insertion loss of the cable system over a given frequency range.
- OTG USB communication port for connection to Bird power sensors, storage devices and charging.

#### KIT INCLUDES



RAILHAWK™

7020-1-010101  
POWER SENSORSK-CAL-MN-C6  
CALIBRATION COMBOFH-AV-CC  
HARD CARRYING  
CASE4240-550, 4240-401  
ADAPTER KITS25-T-MN  
TERMINATION/LOAD  
RESISTOR



# PRECISION RF PRODUCTS

## Minimize Process Variability with Precision RF Measurement Tools

Bird Laboratory Grade RF Products range from our 4020 Series RF power sensors capable of 3% accuracy to the advanced 7037 Series pulse power sensors capable of 0.5% accuracy. These highly accurate sensors have also been integrated into turnkey calibration carts that comprise all the components required to measure, display, and dissipate power from RF delivery systems. Even more sophisticated systems, the BDS has been developed to not only measure voltage and current but also the phase relationships between them to enable a higher degree of insight into modern, complex semiconductor processes.



**POWER METERS**

Page 23



**RF POWER SENSORS**

Page 24 - 29



**DIAGNOSTIC SYSTEMS**

Page 30 - 31



**CALIBRATION CARTS**

Page 32 - 36



**RF CALIBRATION KIT**

Page 37



# Improving Process Consistency with Precision RF Power Measurement

Technological innovation continues to intensify with semiconductor designs that incorporate smaller features and higher densities. To fabricate these latest designs, an advanced level of process control is paramount. For processes that rely on plasma generation, RF power consistency is essential for optimizing performance, maximizing yields, and minimizing downtime.

Bird's Precision RF Products enable you to address RF measurement challenges with the highest precision instruments in the market. Our power sensor solutions that measure both continuous wave and pulsed signals future proof your RF measurement needs. In addition, the Bird Diagnostic System provides detailed insight with measurements made in close proximity to the plasma chamber. Further, calibration carts with built in sensor, meter and load simplifies the task of verifying RF performance across a site's entire fleet of tools.

## 1 WHAT IS THE DIFFERENCE BETWEEN POWER MEASUREMENTS AND VOLTAGE, CURRENT & PHASE MEASUREMENTS?

**Power Measurements** - Power measurements are made using directional couplers that sample the RF signal present in the delivery path. However, due to a coupler's finite directivity, the system's characteristic impedance needs to be maintained close to 50 Ohms. Within this part of the RF delivery system, Bird's Power Sensors have been the industry standard for precision power measurements. These sensors are easy to use with excellent accuracy and repeatability.

**Voltage, Current & Phase Measurements** - The impedance of a plasma chamber is complex and changes with each step of a process recipe. Measurements made with a power sensor in this impedance space will result in directivity errors. In this situation, the RF Signal can be measured by its voltage and current. In addition, the phase relationship between the voltage and current measurements can also be determined to provide a complete description of the signal. The Bird Diagnostic System provides the ideal RF measurement solution for applications such as delivered power measurement, end-point detection, and transient detection.

## 2 WHY IS CALIBRATION IMPORTANT?

Calibration that is traceable to the National Institute of Standards and Technology (NIST) is crucial in ensuring sensor accuracy and consistency across multiple measurement devices. This consistency enables an organization to develop a process at one location and then to proliferate it to multiple production lines across the globe.

Bird has a long history of calorimetry, which is the most accurate method of measuring RF power. Over the past decades, Bird has continued to refine this technology to achieve better and better accuracy. The proprietary calorimeters developed by Bird are NIST traceable and are many times more accurate than the products that are calibrated through them. Our 1% and 0.5% power sensors would not be a success without the technological advances Bird has made to calorimetry.

## 3 WHAT ARE APPLICATIONS FOR AN RF POWER SENSOR?

- Calibrate RF generators to ensure setpoint accuracy
- Fingerprint systems to identify performance drifts and to predict failures
- Troubleshoot RF delivery path to root cause performance issues
- Capture critical-to-quality parameters for site-to-site comparisons

## 4 WHAT ARE APPLICATIONS FOR THE BIRD DIAGNOSTIC SYSTEM?

- Improve process control with recipe step end-point detection
- Identify excursions such as arcing within a plasma chamber
- Monitor performance for determining maintenance needs
- Compare chamber-to-chamber performance differences



# Precision RF Products Selection Guide

## POWER SENSOR SELECTION GUIDE

SERIES	ACCURACY	ACCURACY RANGE	SIGNAL TYPE	FREQUENCY RANGE	MEASUREMENT
7037	0.5%	At calibration frequencies, across specified power range	Multi-level pulse & CW	0.4 MHz to 60 MHz	Forward Average Power, Forward Pulse Power, Reflected Average Power, Match
7027	1%	At calibration frequencies, across specified power range	Multi-level pulse & CW	0.4 MHz to 60 MHz	Forward Average Power, Forward Pulse Power, Reflected Average Power, Match
4027A	1%	At calibration frequencies, at 1700 W	CW	0.25 MHz to 170 MHz	Forward Average Power, Reflected Average Power, Match
4027F	1%	At calibration frequencies, at 1700 W	CW (includes sensor filters for harmonics)	1.8 MHz to 63 MHz	Forward Average Power, Reflected Average Power, Match
4028	2%	At calibration frequencies, at 1700 W	CW	0.25 MHz to 30 MHz	Forward Average Power, Reflected Average Power, Match
4020	3%	Across specified frequency and power ranges	CW	0.1 MHz to 3 GHz	Forward Average Power, Reflected Average Power, Match

## DIAGNOSTIC SYSTEM SELECTION GUIDE

SERIES	VOLTAGE & CURRENT ACCURACY	CALIBRATION	SIGNAL TYPE	FREQUENCY RANGE	MEASUREMENT
BDS2-Locked	Up to 1%	As a system	Multi-level pulse & CW	0.307 MHz to 250 MHz	V, I, Phase, Power
BDS2-Unlocked	Up to 2%	Individual components	Multi-level pulse & CW	0.307 MHz to 250 MHz	V, I, Phase, Power

## CALIBRATION CART SELECTION GUIDE

SERIES	ACCURACY	# OF SENSORS	FREQUENCY	POWER LEVEL
SCC7	Up to 1% or 3%, depending on sensor	1	Up to 170 MHz	Up to 1 kW, 2.5 kW, 5 kW or 10 kW, depending on load and sensor
SCC8	Up to 2%, depending on sensor	1	Up to 30 MHz	Up to 25 kW, depending on sensor
MSCC7	Up to 1% or 3%, depending on sensor	2 (only one can be powered up at a time)	Up to 30 MHz	Up to 5 kW or 10 kW, depending on load and sensors

## POWER METER SELECTION GUIDE

SERIES	# OF SENSORS	# OF SENSOR CHANNELS	INTERFACES
4421A-10-00-0	Single 402x Sensor	1	None
4421A-20-00-0	Dual 402x Sensors	2	None
4421A-10-11-0	Single 402x Sensor	1	RS-232, LAN
4421A-20-11-0	Dual 402x Sensors	2	RS-232, LAN
4421A-12-11-1	Single 402x Sensor Dual 702x/703x Sensors**	2	RS-232, LAN

\*\* 702x/703x Sensors are currently supported for Average Power measurements. Pulse Power parameter measurements will be added with a free, in-field installable software update in 2023.



## Multifunction Power Meters

### MODEL 4421A

The Model 4421A is a Multifunction Power Meter to be used in combination with Bird's Precision Power Sensors to display RF power readings with up to .5% accuracy. This intuitive display unit clearly identifies the Forward and Reflected power measurements within the RF path. In addition, return loss readings can also shown to provide additional insight into the RF system being monitored.

### PRODUCT FEATURES

- Compatible with the full line of Bird's 402x-Series power sensors
- Automatic sensor detection for seamless integration
- Large 9.7 in full color LCD touchscreen display for easy readability
- Dual sensor option expands measurement capabilities
- Compact, lightweight, and portable design enhances functionality

### FUNCTIONS

- Forward Power in W or dBm
- Reflected Power in W or dBm
- Return Loss in VSWR, RL, or Reflection Coefficient
- Graph of Power in W Over Time



	4421A-10-00-0	4421A-20-00-0	4421A-10-11-0	4421A-20-11-0	4421A-12-11-1
# of Sensors	Single 402x Sensor	Dual 402x Sensors	Single 402x Sensor	Dual 402x Sensors	Single 402x Sensor Dual 702x/703x Sensors**
# of Sensor Channels	1	2	1	2	2
Interface	None	None	RS-232, LAN	RS-232, LAN	RS-232, LAN
# of Latch-n-Lock Cables included	1	2	1	2	1

\*\* 702x/703x Sensors are currently supported for Average Power measurements. Pulse Power parameter measurements will be added with a free, in-field installable software update in 2023.

### MEASUREMENT

Compatible Bird Sensors	4021, 4022, 4023, 4024, 4025, 4027 Series, 4028 Series, 702x, 703x
Frequency Range	Sensor dependent
Power Range	Sensor dependent
Sensor Channels	Model dependent, 1 or 2
VSWR Display	1.0 to 199.9
Return Loss Display	0 to 40 dB

### CONNECTORS

Interfaces	Model dependent: RS-232, RJ-45
------------	--------------------------------

### SYSTEM

Display	9.7 in TFT full color LCD with touch screen
AC Power	100-240 VAC, 50/60 Hz, 30 W
Fuse Rating	1A, IEC (5 x 20 mm), time-delay
Battery Type	Internal, rechargeable
Battery Operating Time	Up to 7 hours
Battery Charger	Built-in. Approximately 4 hours to fully recharge.

### PHYSICAL

Size	10.6 in x 9.7 in x 3.6 in (269 mm x 246 mm x 91 mm)
Weight	Less than 5 lb

### ENVIRONMENTAL

Operating Temperature	0 °C to 40 °C
Storage Temperature <sup>1</sup>	10 °C to 50 °C < 1 month 10 °C to 35 °C < 6 months 10 °C to 25 °C > 6 months
Humidity	95% max, non-condensing
Altitude	4,600 m max

### CERTIFICATIONS

CE	CE Compliant
Shock and Vibration	MIL-PRF-28800F Class 4 Compliant

<sup>1</sup>Storage temperature limited by battery specification. Storage outside this range may degrade battery performance. For best performance, a full recharge is recommended every 6 months or if stored below 0 °C.



## PRODUCT FEATURES

- Time domain display
- Gated power measurements with up to four sets of gates available
- Capable of  $\pm 0.5\%$  power measurement accuracy
- NIST traceable calibration
- Measure pulse state widths down to 1 $\mu$ s (sensor dependent)
- Measure pulse rep. rates from 10 Hz up to 100 kHz
- Harmonic filtering
- External sync input
- RF Interlock (optional)
- Automate with SCPI command set

## BENEFITS

- Enhances the set point accuracy of the RF sources
- Optimizes source-to-source consistency across the fleet
- Delivers power measurements to 0.5% accuracy across its dynamic range
- Simplifies measurements of multilevel pulses
- Streamlines data collection efforts via UI or API

# Precision RF Power Sensors

## 7037 SERIES

0.5% ACCURACY

Bird's® 7037 Series RF Power Sensor is capable of a stunning 0.5% accuracy for measurements of the CW and pulsed signals. This precision sensor is an invaluable tool for development and production engineers who require the most precise accuracy in lab and semiconductor fab environments. Calibration is NIST traceable.

7037	FREQUENCY RANGE	POWER RANGE	PULSE REP RATE
7037-1-524001-xyxy	0.4 MHz $\pm 10\%$	25 W to 25 kW	10 Hz to 11.25 kHz
7037-1-544301-xyxy	2 MHz $\pm 10\%$	10 W to 10 kW	10 Hz to 50 kHz
7037-1-595701-xyxy	13.56 MHz $\pm 5\%$	100 W to 10 kW	100 Hz to 100 kHz
7037-1-605801-xyxy	27.12 MHz $\pm 5\%$	60 W to 6 kW	100 Hz to 100 kHz
7037-1-616101-xyxy	40.68 MHz $\pm 5\%$	75 W to 7.5 kW	100 Hz to 100 kHz
7037-1-625801-xyxy	60 MHz $\pm 5\%$	60 W to 6 kW	100 Hz to 100 kHz

Connector Options (xyxy): 7/16 DIN, N, HN, LC, QRM and others that are available on request

### MEASUREMENT

Measurement Type	CW & Multi-State Pulsed RF Power
Impedance	50 Ohms nominal
7037 Series Power Measurement Accuracy	.5% at calibrated frequencies 1.5% at all other frequencies within sensor bandwidth
VSWR Range	1.0:1 to 2.0:1
Insertion Loss	<0.05 dB max
Insertion VSWR	1.05 max
Directivity	28 dB min

### CONNECTORS

RF Connectors	QC 7/16 DIN, N, HN, LC, QRM and others that are available on request
---------------	--

### SYSTEM

Recommended Calibration Interval	6 months
Interface	USB 2.0
Power Supply	Via supplied USB Cable
External Sync Input	TTL High, 2-5 V TTL Low, 0-0.85 V
Compatible With	VPM3

### ENVIRONMENTAL

Operating Temperature	15 °C to 35 °C (59 °F to 95 °F)
Storage Temperature	-20 °C to 70 °C (-4 °F to 158 °F)
Humidity	95% max (non-condensing)
Altitude	15,000 ft max (4,500 m max)

### PHYSICAL

Size	6.0 in x 3.7 in x 1.9 in (155 mm x 95 mm x 50 mm) Not including QC connectors
Weight	Less than 3 lb

### CERTIFICATIONS

Mechanical Shock and Vibration	Designed to meet MIL-PRF-28800F class 3
EMC	EMC Directive (2004/108/EC) European Standard: EN 61326 Electrical Equipment for measurement, control and laboratory use EMC Requirements: Test Spec (for radiated immunity) EN 61000-4-3 - Testing and measurement techniques - 10V/meter
CE	CE Compliant
RoHS	Compliant





## Precision RF Power Sensors

### 7027 SERIES

1% ACCURACY

Bird's® 7027 Series RF Power Sensors for precision semiconductor applications bring reliable and traceable accuracy to development and production engineers in lab and semiconductor fab environments. At calibrated frequencies, this sensor is capable of 1% accuracy for measurements of the CW and pulsed signals. Calibration is NIST traceable.

### PRODUCT FEATURES

- Time domain display
- Gated power measurements with up to four sets of gates available
- Capable of  $\pm 1\%$  power measurement accuracy
- NIST traceable calibration
- Measure pulse state widths down to 1 $\mu$ s (sensor dependent)
- Measure pulse rep. rates from 10 Hz up to 100 kHz
- Harmonic filtering
- External sync input
- RF Interlock (optional)
- Automate with SCPI command set

### BENEFITS

- Enhances the set point accuracy of the RF sources
- Optimizes source-to-source consistency across the fleet
- Delivers power measurements to 1% accuracy across its dynamic range
- Simplifies measurements of multilevel pulses
- Streamlines data collection efforts via UI or API

7027	FREQUENCY RANGE	POWER RANGE	PULSE REP RATE
7027-1-524001-xyxy	0.4 MHz $\pm 10\%$	25 W to 25 kW	10 Hz to 11.25 kHz
7027-1-544601-xyxy	2 MHz $\pm 10\%$	10 W to 5 kW	10 Hz to 50 kHz
7027-1-594301-xyxy	13.56 MHz $\pm 5\%$	10 W to 10 kW	100 Hz to 100 kHz
7027-1-604801-xyxy	27.12 MHz $\pm 5\%$	10 W to 3 kW	100 Hz to 100 kHz
7027-1-615501-xyxy	40.68 MHz $\pm 5\%$	75 W to 7.5 kW	100 Hz to 100 kHz
7027-1-624901-xyxy	60 MHz $\pm 5\%$	30 W to 6 kW	100 Hz to 100 kHz

**Connector Options (xyxy):** 7/16 DIN, N, HN, LC, QRM and others that are available on request

### MEASUREMENT

<b>Measurement Type</b>	CW & Multi-State Pulsed RF Power
<b>Impedance</b>	50 Ohms nominal
<b>7027 Series Power Measurement Accuracy</b>	1% at calibrated frequencies 2% at all other frequencies within sensor bandwidth
<b>VSWR Range</b>	1.0:1 to 2.0:1
<b>Insertion Loss</b>	<0.05 dB max
<b>Insertion VSWR</b>	1.05 max
<b>Directivity</b>	28 dB min

### CONNECTORS

<b>RF Connectors</b>	QC 7/16 DIN, N, HN, LC, QRM and others that are available on request
----------------------	--

### SYSTEM

<b>Recommended Calibration Interval</b>	6 months
<b>Interface</b>	USB 2.0
<b>Power Supply</b>	Via supplied USB Cable
<b>External Sync Input</b>	TTL High, 2-5 V TTL Low, 0-0.85 V
<b>Compatible With</b>	VPM3

### ENVIRONMENTAL

<b>Operating Temperature</b>	15 °C to 35 °C (59 °F to 95 °F)
<b>Storage Temperature</b>	-20 °C to 70 °C (-4 °F to 158 °F)
<b>Humidity</b>	95% max (non-condensing)
<b>Altitude</b>	15,000 ft max (4,500 m max)

### PHYSICAL

<b>Size</b>	6.0 in x 3.7 in x 1.9 in (155 mm x 95 mm x 50 mm) Not including QC connectors
<b>Weight</b>	Less than 3 lb

### CERTIFICATIONS

<b>Mechanical Shock and Vibration</b>	Designed to meet MIL-PRF-28800F class 3
<b>EMC</b>	EMC Directive (2004/108/EC) European Standard: EN 61326 - Electrical Equipment for measurement, control and laboratory use EMC Requirements Test Spec (for radiated immunity) EN 61000-4-3 - Testing and measurement techniques - 10V/meter
<b>CE</b>	CE Compliant
<b>RoHS</b>	Compliant



# Precision Directional RF Power Sensors

## 4027A SERIES

±1% ACCURACY

The 4027A Series Power Sensors from Bird bring superb accuracy and ease of use together for the laboratory engineer. In semiconductor processing and other precision process applications where accuracy is critical, these sensors are capable of 1% accuracy at the calibrated frequency and power level. Calibration is traceable to the National Institute of Standards and Technology (NIST), providing additional confidence in sensor measurement.

4027A	FREQUENCY RANGE	POWER RANGE
4027A12M	10 to 15 MHz	300 mW to 1 kW
4027A250K	250 to 400 kHz	3 W to 10 kW
4027A400K	400 to 550 kHz	3 W to 10 kW
4027A800K	800 to 950 kHz	3 W to 10 kW
4027A2M	1.5 to 2.5 MHz	3 W to 10 kW
4027A4M	3 to 5 MHz	3 W to 10 kW

	FREQUENCY RANGE	POWER RANGE
4027A10M	10 to 15 MHz	3 W to 10 kW
4027A25M	25 to 30 MHz	3 W to 9 kW
4027A35M	35 to 45 MHz	3 W to 7.5 kW
4027A60M	45 to 65 MHz	3 W to 6 kW
4027A100M	95 to 105 MHz	3 W to 4 kW
4027A150M	150 to 170 MHz	3.75W to 3.75 kW

## PRODUCT FEATURES

- 1% accuracy at specified frequencies and power levels
- Models do not need to be field calibrated before use and only need to be calibrated once every six months
- Plug and Play with the 4421A Multifunction Meter
- Dozens of connector options available
- Calibration traceable to the National Institute of Standards and Technology

## FOR USE WITH

- 4421A Multifunction Power Meters
- SCC7 Calibration Cart
- MSSC7 Calibration Cart

## BENEFITS

- Enhances the set point accuracy of the CW RF source
- Optimizes source-to-source consistency across the fleet
- Delivers forward and reflected power measurements to 1% accuracy
- Reduces ambiguity with straightforward operation and measurement display

## MEASUREMENT

<b>Accuracy</b>	±1% at calibration frequencies and power levels ±2% at other frequency and power levels - add 2% to uncertainty outside 25 ±10 °C
<b>Uniformity</b>	2% maximum unit to unit, at calibration frequency and power levels
<b>Speed</b>	2 readings per second
<b>Harmonic Content</b>	-50 dBc max
<b>VSWR Range</b>	1.00 to 2.00
<b>Directivity</b>	28 dB
<b>Insertion Loss</b>	<0.05 dB

<b>Calibration Power Level</b>	1000 W units: 700 W Other units: 1700 W
<b>Maximum Power</b>	Sensor Frequency Dependent

## CONNECTORS

<b>RF Connectors</b>	Customer specified
----------------------	--------------------

## SYSTEM

<b>Recommended Calibration Interval</b>	6 month. Performance before and performance after data supplied with recalibrations
<b>Power Supply</b>	External DC, 12VDC, supplied from Bird 4421A Power Meter

## ENVIRONMENTAL

<b>Operating Temperature</b>	0 °C to 50 °C (32 °F to 122 °F)
<b>Storage Temperature</b>	-20 °C to 70 °C (-4 °F to 158 °F)
<b>Humidity</b>	95% max (non-condensing)
<b>Altitude</b>	Up to 10,000 ft (3,048m)

## PHYSICAL

<b>Size</b>	5.2 in x 2.5 in x 3.25 in (137 mm x 64 mm x 83 mm)
<b>Weight</b>	1 lb 13 oz (0.8 kg)

## CERTIFICATIONS

<b>EMC</b>	Designed to carry CE mark
------------	---------------------------



## Precision Filtered RF Power Sensors

### 4027F SERIES

±1% ACCURACY

The Bird 4027F Series RF Power Sensors are designed specifically for use in semiconductor processing and other precision process applications where the effects of amplitude modulation and harmonics need to be eliminated from the measurement. Because accuracy is critical, these sensors are capable of ±1% accuracy at the calibrated frequency and power level. Calibration is traceable to the National Institute of Standards and Technology (NIST), providing additional confidence in sensor measurement.

	4027F2M	4027F10M	4027F60M
<b>Frequency Range</b>	1.8 to 2.2 MHz	12 to 15 MHz	57 to 63 MHz
<b>Power Range</b>	100 W to 10 kW	100W to 10 kW	100W to 6 kW
<b>Calibration Frequency, Type</b>	1.8, 2.0, 2.17 MHz	12.0, 12.5, 13.56, 14.0, 15.0 MHz	57.0, 58.5, 60.0, 61.5, 63 MHz
<b>Harmonic Rejection, Min</b>	26 dB@3.6 MHz to 3.8 MHz, 30 dB@>3.8 MHz	30 dB@>25 MHz	30 dB@>114.0 MHz
<b>LF Rejection</b>	Not specified	30 dB@<1 MHz	30 dB@<15.0 MHz
<b>Max Error Induced by 10% AM</b>	0.2%@<5 kW, 1%@5 kW to 10 kW	0.2%@<5 kW, 1%@5 kW to 10 kW	0.2%@<1.5 kW, 1%@1.5 kW to 3 kW

### MEASUREMENT

<b>Accuracy</b>	±1% at calibration frequencies and power levels, ±2% at other frequency and power levels Add 2% to uncertainty outside 25 ±5 °C
<b>Uniformity</b>	2% maximum unit to unit, at calibration frequency and power levels
<b>Speed</b>	2 readings per second
<b>VSWR Range</b>	1.00 to 2.00
<b>Directivity</b>	28 dB
<b>Insertion Loss</b>	<0.05 dB
<b>Calibration Power Level</b>	1700 W
<b>Maximum Power</b>	10 kW units: 12 kW max 6 kW units: 7.2 kW max

### CONNECTORS

<b>RF Connectors</b>	Customer specified
----------------------	--------------------

### SYSTEM

<b>Recommended Calibration Interval</b>	6 month. Performance before and performance after data to be supplied for units
<b>Power Supply</b>	External DC, 12 VDC, supplied from Bird 4421A Power Meter

### CERTIFICATIONS

<b>EMC</b>	Designed to carry CE mark
------------	---------------------------

### ENVIRONMENTAL

<b>Operating Temperature</b>	0 °C to 50 °C (32 °F to 122 °F)
<b>Storage Temperature</b>	-20 °C to 70 °C (-4 °F to 158 °F)
<b>Humidity</b>	95% max (non-condensing)
<b>Altitude</b>	Up to 10,000 ft (3,048 m)

### PHYSICAL

<b>Size</b>	5.2 in x 2.5 in x 3.25 in (137 mm x 64 mm x 83 mm)
<b>Weight</b>	1 lb 13 oz (0.8 kg)

### PRODUCT FEATURES

- Provides filtered measurement where the effects of amplitude modulation and harmonics need to be eliminated
- ±1% accuracy at specified frequencies and power levels
- Models do not need to be field calibrated before use and only need to be calibrated once every 6 months
- Plug and Play with the 4421A Series Multifunction Power Meter
- Dozens of connector options available

### FOR USE WITH

- 4421A Multifunction Power Meters
- SCC7 Calibration Cart
- MSCC7 Calibration Cart

### BENEFITS

- Enhances the set point accuracy of the CW RF source
- Optimizes source-to-source consistency across the fleet
- Delivers forward and reflected power measurements to 1% accuracy
- Maximizes the measurement accuracy of your main signal by filtering harmonics





# RF Directional ThruLine Power Sensors

## 4028 SERIES

±2% ACCURACY

The Bird 4028 Series RF Directional ThruLine Power Sensors are designed specifically for use in high power LCD, TFT and Solar processing as well as other precision high power applications. Because accuracy is critical, these sensors are capable of ±2% accuracy at the calibrated frequency and power level which can improve accuracy and long-term repeatability for significant improvements on your process yields

4028	FREQUENCY RANGE	POWER RANGE
4028A250K	250 to 400 kHz	1.0 to 20 kW
4028A400K	400 to 550 kHz	1.0 to 20 kW
4028A2M	1.5 to 2.5 MHz	1.0 to 25 kW
4028A3M	2.5 to 3.5 MHz	1.0 to 25 kW
4028A4M	3.5 to 4.5 MHz	1.0 to 25 kW

	FREQUENCY RANGE	POWER RANGE
4028A10M	10 to 15 MHz	1.0 to 25 kW
4028A25M	25 to 30 MHz	1.0 to 25 kW
4028B3M	2.5 to 4 MHz	1.0 to 25 kW
4028B10M	10 to 15 MHz	1.0 to 25 kW
4028C10M	10 to 15 MHz	500 W to 50 kW

## PRODUCT FEATURES

- Specifically designed for use in high power LCD, TFT and Solar processing and other precision high power applications up to 50 kW
- ±2% accuracy at specified frequencies and power levels
- Models do not need to be field calibrated before use and only need to be calibrated once every year
- Plug and Play with the 4421A Series Multifunction Power Meter
- Dozens of connector options available
- Calibration traceable to the National Institute of Standards and Technology

## FOR USE WITH

- 4421A Multifunction Power Meters
- SCC8 Calibration Cart

## BENEFITS

- Enhances the set point accuracy of the CW RF source
- Optimizes source-to-source consistency across the fleet
- Delivers forward and reflected power measurements to 2% accuracy
- Supports measurements of higher power signals used in industrial processes

### MEASUREMENT

<b>Accuracy</b>	±2% at calibration frequencies and power levels ±3% at other frequency and power levels Add 2% to uncertainty outside 25 ±10 °C
<b>Accuracy, Rfl</b>	Calculated from Fwd accuracy +, (Fwd Power/10 <sup>Δ</sup> {directivity/10})
<b>VSWR, Max</b>	2.00:1
<b>Directivity, Min</b>	28 dB
<b>Insertion Loss, Max</b>	0.05 dB (with female 7/16 DIN connectors)
<b>Impedance, Nominal</b>	50 Ohms
<b>Speed</b>	2 readings per second
<b>Repeatability, multiple measurements, single sensor</b>	±0.3% (95% c.l.) (with female 7/16 DIN connectors)
<b>Calibration Power Level</b>	1.7 kW

### CONNECTORS

<b>RF Connectors</b>	A Series Customer specified B Series 1 5/8" EIA Flanged C Series 3 1/8" EIA Flanged
<b>Sensor Interface</b>	Latch-n-Lock

### SYSTEM

<b>Recommended Calibration Interval</b>	1 year
<b>Power Supply</b>	Supplied by power meter via sensor cable

### ENVIRONMENTAL

<b>Operating Temperature</b>	0 °C to 50 °C (32 °F to 122 °F)
<b>Storage Temperature</b>	-20 °C to 70 °C (-4 °F to 158 °F)
<b>Humidity</b>	95% max (non-condensing)
<b>Altitude</b>	10,000 ft (3,000 m)

### PHYSICAL

<b>Size, Nom</b>	A Series 4.7 in x 3.2 in x 3.8 in (120 mm x 82 mm x 97 mm) (w/o connectors) B Series 6.8 in x 3.5 in x 4.8 in (171 mm x 89 mm x 121 mm) C Series 8.0 in x 5.2 in x 6.4 in (203 mm x 131 mm x 162 mm)
<b>Weight, Nom</b>	A Series 1.7 lb (0.8 kg) B Series 3.3 lb (1.5 kg) C Series 7.3 lb (3.3 kg)

### CERTIFICATIONS

<b>EMC</b>	Designed to carry CE mark
------------	---------------------------



## RF Directional Thruline Power Sensors

### 4020 SERIES

±3% ACCURACY

Five models of the Bird 4020 Directional RF Power Sensor Series cover the frequency range of 100 kHz to 3 GHz and power range from 300 mW to 10 kW. These sensors have low insertion loss and full-scale accuracy  $\pm 3\%$  for applications requiring accurate forward and reflected power measurement. Also offers direct plug-in operation with industry-standard Bird 4421A Series Multifunction Power Meters.

### PRODUCT FEATURES

- Models cover frequency range of 100 kHz to 3 GHz
- Models cover power range from 300 mW to 10 kW
- Low insertion loss and full-scale accuracy  $\pm 3\%$
- Direct plug-in operation with industry-standard Bird 4421A Series Multifunction Power Meters

### FOR USE WITH

- 4421A Multifunction Power Meters
- SCC7 Calibration Cart
- MSCC7 Calibration Cart

### BENEFITS

- Enhances the set point accuracy of the CW RF source
- Optimizes source-to-source consistency across the fleet
- Delivers forward and reflected power measurements to 3% accuracy
- Provides the flexibility of measuring various sources with its wideband capability

	4021	4022	4023A3G	4024	4025
<b>Frequency Range</b>	1.8 to 32 MHz	25 MHz to 1 GHz	800 to 3 GHz	1.5 to 32 MHz	100 kHz to 2.5 MHz
<b>Power Range</b>	300 mW to 1 kW (1.2 kW max)	300 mW to 1 kW (1.2 kW max)	300 mW to 200 W	3 W to 10 kW (12 kW max)	3 W to 10 kW (12 kW max)
<b>Insertion Loss Max</b> (with female "N" connector)	0.05 dB	0.05 dB, 25 to 512 MHz, 0.13 dB, 512 MHz to 1 GHz	0.15 dB	0.05 dB	0.05 dB
<b>Insertion VSWR</b> (with female "N" connector)	1.05:1	1.05:1: 25 to 512 MHz, 1.10:1: 512 MHz to 1 GHz	1.10:1	1.05:1	1.05:1
<b>Directivity</b>	30 dB	30 dB: 25 to 400 MHz 26 dB: 400 to 1000 MHz	28 dB	28 dB: 1.5-2.5 and 25 to 32 MHz 30 dB: 2.5 to 25 MHz	28 dB: 100 to 125 kHz 30 dB: 125 to 2500 kHz

### MEASUREMENT

**Impedance, Nominal** 50 Ohms

**Accuracy**  $\pm 3\%$  of reading, with no more than 1% AM, harmonics -50 dBc or less, terminating VSWR 2:1 or less

**VSWR Range** 1.00 to 2.00  
(40.0 to 9.5 dB Return Loss)

### CONNECTORS

**RF Connectors** N(f) standard, other customer specified from QC list appropriate for frequency and power.

### SYSTEM

**Recommended Calibration Interval** Nominal 1 year

**Power Supply** External DC, 12VDC, supplied from Bird 4421A Power Meter

### ENVIRONMENTAL

**Operating Temperature** 0 °C to 50 °C (32 °F to 122 °F)

**Storage Temperature** -20 °C to 70 °C (-4 °F to 158 °F)

**Humidity** 95% max (non-condensing)

**Altitude** Up to 10,000 ft (3,048 m)

### PHYSICAL

**Size** 5.2 in x 2.5 in x 3.25 in  
(137 mm x 64 mm x 83 mm)

**Weight** 1 lb 11 oz (0.8 kg)

### CERTIFICATIONS

**EMC** Designed to carry CE mark



## PRODUCT FEATURES

- 1% accurate measurement of RF voltage and current with a locked system
- Calculated impedance, RF power
- Multi-level pulse or CW waveforms
- 1-3 fundamental frequencies
- 4 harmonics per fundamental frequency
- 6 intermodulation products per fundamental pair
- Time-domain mode
- Tracking & Spectral search mode
- Ethernet enabled

## APPLICATIONS

- Chamber to chamber matching
- RF process monitoring
- Impedance matching
- Troubleshooting RF delivery system
- Identify process drifts
- Harmonic levels up to 252 MHz are available for analysis
- Voltage, current, phase and delivered power comparison

# Inline VI Probe System

## BIRD DIAGNOSTIC SYSTEM (BDS2)

Using sophisticated parallel signal processing, the BDS2 simultaneously measures and reports voltage, current, and phase angle at multiple fundamental, harmonic and intermodulation frequencies. A robust frequency tracking algorithm guarantees accurate measurements under dynamic signal conditions. With this data, power and impedance are calculated at each frequency, giving users the ability to identify small discrepancies that may make the difference between a successful and a failed process.

### MEASUREMENT

<b>Measurements</b>	Voltage, current, phase, frequency, impedance, power at frequencies selected by user
<b>Frequency Range</b>	307 kHz to 252 MHz (Sensor Dependent)
<b>Frequency Resolution</b>	100 kHz
<b>Frequency Accuracy</b>	±1 kHz
<b>Number of Fundamentals</b>	Up to 3 simultaneously. For more than 1 fundamental, choose from the following (or contact the factory for custom combinations): - 0.4, 13.56, 160 MHz - 0.4, 60 MHz - 1, 13.56 MHz - 2, 27.12, 60 MHz - 3.2, 40.68 MHz - 3.2, 60 MHz - 12.88, 40.68 MHz - 13.56, 100 MHz

<b>Tracking Frequency Slew Rate</b>	2 GHz/sec
<b>Tracking Minimum Pulse Width</b>	5 µsec
<b>Number of Harmonics</b>	Limited by the maximum number of measurement channels  Tracking & Spectral search mode: 12 harmonics standard mode 6 in time domain mode
<b>Update Rates</b>	100 Hz typical
<b>Network Protocol</b>	Ethernet
<b>RF Power Max</b>	Determined by RF sensor, (Typically 10 kW or higher)
<b>RF Connector</b>	Custom or QC
<b>Operating Modes</b>	Tracking mode, Spectral Search mode

### ENVIRONMENTAL

<b>Receiver Operating Temperature</b>	20 °C to 40 °C (68 °F to 104 °F)
<b>Receiver Storage Temperature</b>	-20 °C to 80 °C (-4 °F to 176 °F)
<b>Cable Operating Temperature</b>	0 °C to 100 °C (32 °F to 212 °F)
<b>Cable Storage Temperature</b>	-20 °C to 100 °C (-4 °F to 212 °F)
<b>Sensor Operating/Storage Temperature</b>	Refer to sensor specification
<b>Humidity</b>	85% max (non-condensing)
<b>Air Pressure</b>	745 mbar (equivalent to 2,500 m/ 8,200 ft max altitude)

### POWER

<b>Operating Power</b>	15 VDC, 2.5 A nominal
------------------------	-----------------------



# Inline VI Probe System BIRD DIAGNOSTIC SYSTEM (BDS2)

## SYSTEM PROFILES

	VOLTAGE	CURRENT	PHASE ANGLE
<b>Measurement</b>	RF: 1 to 3000V <sub>rms</sub> (Note 1)	0.1 to 100 A <sub>rms</sub> (Note 1)	-180° to + 180°
<b>Resolution</b>	IEEE 754 Single Precision Floating Point		
<b>Uncertainty 307 kHz to 1 MHz Locked System</b> (Note 2)	for F <sub>r</sub> , ±0.5 V or 1% of reading whichever is greater for F <sub>n</sub> , ±1.0 V or 2% of reading, whichever is greater (95% confidence interval)	for F <sub>r</sub> , ±0.05 A or 1% of reading whichever is greater for F <sub>n</sub> , ±0.1 A or 2% of reading, whichever is greater (95% confidence interval)	<b>Absolute Angle:</b> F <sub>r</sub> ≥ 10 V, 1A: ±1° F <sub>r</sub> < 10 V, 1A: ±4°
<b>Uncertainty 1 to 252 MHz Locked System</b> (Note 2)	for F <sub>r</sub> , ±0.1 V or 1% of reading whichever is greater for F <sub>n</sub> , ±0.2 V or 2% of reading, whichever is greater (95% confidence interval)	for F <sub>r</sub> , ±0.01 A or 1% of reading whichever is greater for F <sub>n</sub> , ±0.02 A or 2% of reading, whichever is greater (95% confidence interval)	F <sub>r</sub> ≥ 10 V, 1A: ±2° F <sub>r</sub> < 10 V, 1A: ±6° (95% confidence interval)
<b>Uncertainty 307 kHz to 1 MHz Unlocked System</b> (Note 2)	for F <sub>r</sub> , ±1.0 V or 2% of reading whichever is greater for F <sub>n</sub> , ±2.0 V or 4% of reading, whichever is greater (95% confidence interval)	for F <sub>r</sub> , ±0.1 A or 2% of reading whichever is greater for F <sub>n</sub> , ±0.2 A or 4% of reading, whichever is greater (95% confidence interval)	<b>Absolute Angle:</b> F <sub>r</sub> ≥ 10 V, 1A: ±1° F <sub>r</sub> < 10 V, 1A: ±4°
<b>Uncertainty 1 to 252 MHz Unlocked System</b> (Note 2)	for F <sub>r</sub> , ±0.2 V or 2% of reading whichever is greater for F <sub>n</sub> , ±0.4 V or 4% of reading, whichever is greater (95% confidence interval)	for F <sub>r</sub> , ±0.02 A or 2% of reading whichever is greater for F <sub>n</sub> , ±0.04 A or 4% of reading, whichever is greater (95% confidence interval)	F <sub>r</sub> ≥ 10 V, 1A: ±2° F <sub>r</sub> < 10 V, 1A: ±6° (95% confidence interval)

\*Contact factory for a custom designed sensor and custom frequency combinations.

Note 1: Maximum power is limited by the size of the RF frequency (25 kW max average power at 13.56 MHz).

Note 2: At customer specified frequencies.

## SYSTEM COMPONENTS - UNLOCKED SYSTEM

	DESCRIPTION	CONNECTION OPTIONS
7001A900-2	BDS2 Single Ch. Receiver w/Ethernet	N/A
7001A900-3	BDS2 Single Ch. Receiver w/Ethernet and Serial	N/A
7001B040-5M	RF/Data Cable Set 5 M straight	N/A
7001A550-1-xx yy	Sensor, BDS2, QC Connector (Choose xx yy options from connection options)	<b>Input (xx) and Output (yy) Connectors</b> 01 = N(f)    12 = HN(f)    14 = 7/16(f)    34 = LC(f) 02 = N(m)    13 = HN(m)    15 = 7/16(m)    35 = LC(m)
7001A550-2	Sensor, BDS2, Protruding Dielectric Connection	N/A

\*Contact Bird for additional connector options

## SYSTEM KITS - LOCKED SYSTEM

	DESCRIPTION	CONNECTION OPTIONS
7001A500-1-xyxy	BDS2 Kit (Receiver, Cable and Sensor Kit), QC Connectors (Choose xx yy options from connection options)	<b>Input (xx) and Output (yy) Connectors</b> 01 = N(f)    12 = HN(f)    14 = 7/16(f)    34 = LC(f) 02 = N(m)    13 = HN(m)    15 = 7/16(m)    35 = LC(m)
7001A500-1-2	BDS2 Kit (Receiver, Cable and Sensor Kit), Protruding Dielectric Connection	N/A

\*Contact Bird for additional connector options

## TIME DOMAIN MEASUREMENT MODE (OPTIONAL)

	DESCRIPTION
<b>License Options</b>	Factory Install (7001A993-1) or Field Install (7001A993F-1)
<b>Time Resolution</b>	500 ns
<b>Configurable Time Scale</b>	0.1 to 10 ms
<b>Average</b>	Trace Average
<b>Trigger</b>	Voltage or current waveform, Rising or falling edge, External triggering, Upper/lower thresholds, Holdoff
<b>Pre- and Post- Trigger Buffer</b>	5% to 95%



MADE IN USA

**PRODUCT FEATURES**

- Suitable for use in a clean room environment
- Stainless steel cart is designed for easy transportation and effortless use
- Customizable with choice of power sensor and load configuration
- High return loss ensures minimal power measurement error contribution

**INCLUDES**

- **4421A Multifunction Power Meter** to display RF power readings with up to 1% accuracy
- **A 4020, 4027A or 4027F Series Power Sensor** for accurate RF measurement
- **An Ultra-Stable SC13 or High Power Load** for precision RF power regulation and control



**Single Sensor Calibration Cart**  
**SCC7 SERIES**

The SCC7 Calibration Cart provides the ideal solution for the calibration of RF generators. It combines a high accuracy Bird Power Sensor, a user friendly 4421A Multifunction Power Meter, and a low reflection load in an easily transportable mobile package. The system is indispensable for semiconductor fabs with multiple RF generators in various locations.

**SYSTEM**

<b>Meter</b>	4421A Multifunction Power Meter
<b>Sensor Options</b>	4020 Series, 4027A Series, or 4027F Series
<b>Load Options</b>	Ultra-Stable Load or High Power Load
<b>Sensor Frequency Range</b>	
4020 Series	100 KHz to 1000 MHz
4027A Series	250 KHz to 170 MHz
4027F Series	1.8 MHz to 63 MHz
<b>Sensor Accuracy</b>	
4020 Series	±3% across power and frequency range
4027A Series	±1% at calibration frequency and power levels
4027F Series	±1% at calibration frequency and power levels

<b>Impedance</b>	50 Ohms nominal
<b>Power Requirements</b>	115 or 230 VAC, 50/60 Hz
<b>Connector Type</b>	Customer specified
<b>Operating Position</b>	Vertical only
<b>Casters</b>	4 swivel
<b>Material of Construction</b>	Stainless steel cart

**PHYSICAL**

<b>Size (fully assembled)</b>	
1 kW & 2.5 kW Models	42 in x 20 in x 42 in (107 cm x 51 cm x 107 cm)
5 kW & 10 kW Models	52 in x 20 in x 42 in (132 cm x 51 cm x 107 cm)
<b>Weight (fully assembled)</b>	
1 kW & 2.5 kW Models	175 lb (80kg)
5 kW & 10 kW Models	250 lb (114kg)

**ENVIRONMENTAL**

<b>Ambient Temperature</b>	0 °C to 35 °C (32 °F to 95 °F), (10 kW Model 0 °C to 40 °C/ 32 °F to 104 °F)
<b>Storage Temperature</b>	-20 °C to 70 °C (-4 °F to 158 °F)
<b>Humidity</b>	85% max (non-condensing)
<b>Altitude</b>	Load derated above 5,000 ft (1,524 m)

**CERTIFICATIONS**

<b>CE</b>	CE Compliant
-----------	--------------

# Single Sensor Calibration Cart

## SCC7 SERIES CONFIGURATION GUIDE

### RF POWER SENSORS - CHOOSE ONE (1)



4020 SERIES Directional ThruLine	FREQUENCY RANGE	POWER INPUT
4021	1.8 to 32 MHz	300 mW to 1 kW at 1.2 kW max
4022	25 to 1000 MHz	300 mW to 1 kW at 1.2 kW max
4024	1.5 to 32 MHz	3 W to 10 kW at 1.2 kW max
4025	100 to 2500 kHz	3 W to 10 kW at 1.2 kW max



4027A SERIES Precision Directional	FREQUENCY RANGE	POWER INPUT
4027A250k	250 to 400 kHz	3 W to 10 kW
4027A400k	400 to 550 kHz	3 W to 10 kW
4027A800k	800 to 950 kHz	3 W to 10 kW
4027A2M	1.5 to 2.5 MHz	3 W to 10 kW
4027A4M	3 to 5 MHz	3 W to 10 kW
4027A10M	10 to 15 MHz	3 W to 10 kW
4027A12M	10 to 15 MHz	300 mW to 1 kW
4027A25M	25 to 30 MHz	3 W to 9 kW
4027A35M	35 to 45 MHz	3 W to 7.5 kW
4027A60M	45 to 65 MHz	3 W to 6 kW
4027A100M	95 to 105 MHz	3 W to 4 kW
4027A150M	150 to 170 MHz	3.75 W to 3.75 kW



4027F SERIES Precision Filtered	FREQUENCY RANGE	POWER INPUT
4027F2M	1.8 to 2.2 MHz	100 W to 10 kW
4027F10M	12 to 15 MHz	100 W to 10 kW
4027F60M	57 to 63 MHz	100 W to 6 kW

### RF LOADS - CHOOSE ONE (1)



HIGH POWER LOADS	FREQUENCY RANGE & VSWR	POWER INPUT
8251	DC to 1 GHz @ 1.1 max	1 kW
8890-300	DC to 1 GHz @ 1.1 max, 1 GHz to 2 GHz @ 1.25 max 2 GHz to 2.4 GHz @ 1.3 max	2500 W continuous
8921	DC to 1 GHz @ 1.1 max	5000 W continuous
8931-115	DC to 400 MHz @ 1.15 max 400 MHz to 1 GHz @ 1.20 max	10 kW continuous w/blower on 2.5 kW continuous w/blower off
8931-230	DC to 400 MHz @ 1.15 max 400 MHz to 1 GHz @ 1.20 max	10 kW continuous w/blower on 2.5 kW continuous w/blower off



ULTRA-STABLE LOADS	FREQUENCY RANGE & VSWR	POWER INPUT
8865SC13	DC to 28 MHz @ 1.1 max (VSWR less than 1.05:1)	1 kW
8890-300SC13	DC to 28 MHz @ 1.1 max (VSWR less than 1.05:1)	2.5 kW
8921SC13	DC to 28 MHz @ 1.1 max (VSWR less than 1.05:1)	5 kW
8931-115SC13	DC to 28 MHz @ 1.1 max (VSWR less than 1.05:1)	10 kW
8931-230SC13	DC to 28 MHz @ 1.1 max (VSWR less than 1.05:1)	10 kW





## PRODUCT FEATURES

- Designed to support two power sensors
- Suitable for use in a clean room environment
- Stainless steel cart is designed for easy transportation and effortless use
- Customizable with choice of power sensor and load configuration
- High return loss ensures minimal power measurement error contribution

## INCLUDES

- **4421A Multifunction Power Meter** to display RF power readings with up to 1% accuracy
- **Two 4020, 4027A, or 4027F Power Sensors** for accurate RF measurement
- **A High Power Load** for precision RF power regulation and control



MODEL 4421A

# Dual Sensor Calibration Cart

## MSSC7 SERIES

The MSSC7 Calibration Cart is a unique calibration solution in that it is designed to support two Power Sensors. In addition, it includes a user friendly 4421A Multifunction Power Meter and a high power load in an easily transportable mobile cart. The system is indispensable for semiconductor clean room applications.

### SYSTEM

<b>Meter</b>	4421A Multifunction Power Meter
<b>Sensor Options</b>	Two 4020, 4027A, or 4027F Series
<b>Load</b>	One Bird High Power Load
<b>Frequency Range</b>	100 kHz to 30 MHz, depending on sensor
<b>Sensor Accuracy</b>	
4020 Series	±3% across power and frequency range
4027A Series	±1% at calibration frequency and power levels
4027F Series	±1% at calibration frequency and power levels

<b>Impedance</b>	50 Ohms nominal
<b>Power Requirements</b>	115 or 230 VAC, 50/60 Hz
<b>Connector Type</b>	Customer specified
<b>Operating Position</b>	Vertical only
<b>Casters</b>	4 swivel
<b>Material of Construction</b>	Stainless steel cart

### ENVIRONMENTAL

<b>Operating Temperature</b>	0 °C to 35 °C (32 °F to 95 °F)
<b>Storage Temperature</b>	-20 °C to 70 °C (-4 °F to 158 °F)
<b>Humidity</b>	85% max (non-condensing)
<b>Altitude</b>	Load derated above 5,000 ft (1,524 m)

### PHYSICAL

<b>Size</b>	52 in x 20 in x 42 in (132 cm x 51 cm x 107 cm)
<b>Weight</b>	290 lb (132 kg)

### CERTIFICATIONS

<b>CE</b>	CE Compliant
-----------	--------------

# Dual Sensor Calibration Cart

## MSCC7 SERIES CONFIGURATION GUIDE

### RF POWER SENSORS - CHOOSE TWO (2)



4020 SERIES Directional ThruLine	FREQUENCY RANGE	POWER INPUT
4021	1.8 to 32 MHz	300 mW to 1 kW at 1.2 kW max
4024	1.5 to 32 MHz	3 W to 10 kW at 12 kW max
4025	100 to 2500 kHz	3 W to 10 kW at 12 kW max



4027A SERIES Precision Directional	FREQUENCY RANGE	POWER INPUT
4027A250k	250 to 400 kHz	3 W to 10 kW
4027A400k	400 to 550 kHz	3 W to 10 kW
4027A800k	800 to 950 kHz	3 W to 10 kW
4027A2M	1.5 to 2.5 MHz	3 W to 10 kW
4027A4M	3 to 5 MHz	3 W to 10 kW
4027A10M	10 to 15 MHz	3 W to 10 kW
4027A12M	10 to 15 MHz	300 mW to 1 kW
4027A25M	25 to 30 MHz	3 W to 9 kW



4027F SERIES Precision Filtered	FREQUENCY RANGE	POWER INPUT
4027F2M	1.8 to 2.2 MHz	100 W to 10 kW
4027F10M	12 to 15 MHz	100 W to 10 kW

### RF LOADS - CHOOSE ONE (1)



HIGH POWER LOADS	FREQUENCY RANGE & VSWR	POWER INPUT
8921A100	DC to 30 MHz @ 1.1 max (less than 1.05 typical)	5 kW
8931A400-115	DC to 30 MHz @ 1.1 max (less than 1.05 typical)	10 kW
8931A400-230	DC to 30 MHz @ 1.1 max (less than 1.05 typical)	10 kW



## PRODUCT FEATURES

- Designed for effortless, immediate use
- Suitable for use in a clean room environment
- High return loss ensures minimal power measurement error contribution
- Stainless steel cart with locking wheels is designed for easy transportation and effortless use

## INCLUDES

- **4421A Multifunction Power Meter** to display RF power readings with up to 2% accuracy
- **A 4028 Series Power Sensor** for accurate RF measurement
- **A Bird Moduload** with low reflection 50 Ohm terminations that can dissipate up to 25 kW

# High Power Calibration Cart

## SCC8 SERIES

The SCC8 Calibration Cart provides the ideal solution for the calibration of high power RF generators with power measurement up to 25 kW. It combines the high-accuracy Bird 4028 Series Power Sensor, a user-friendly 4421A Multifunction Power Meter, and a Bird Moduload in an easily transportable mobile package.



MODEL 4421A

## RF POWER SENSORS - CHOOSE ONE (1)



4028 SERIES Directional ThruLine	FREQUENCY RANGE	POWER INPUT
4028A10M	10 to 15 MHz	1 kW to 25 kW
4028A250K	250 to 400 kHz	1 kW to 20 kW
4028A25M	25 to 30 MHz	1 kW to 25 kW
4028A2M	1.5 to 2.5 MHz	1 kW to 25 kW
4028A3M	2.5 to 3.5 MHz	1 kW to 25 kW
4028A400K	400 to 550 kHz	1 kW to 20 kW
4028A4M	3.5 to 4.5 MHz	1 kW to 25 kW
4028B10M	10 to 15 MHz	1 kW to 25 kW
4028B3M	3 to 4 MHz	1 kW to 25 kW

## SYSTEM

<b>Meter</b>	4421A Multifunction Power Meter
<b>Sensor</b>	4028 Series
<b>Load</b>	Bird Moduload
<b>Frequency Range</b>	250 kHz - 30 MHz, depending on sensor
<b>Accuracy</b>	±2% (2s) at calibration frequency and power levels, ±3% (2s) of reading at other power levels and frequencies within sensor range (add 2% to uncertainty outside 25 ±10 °C)
<b>Impedance</b>	50 Ohms nominal
<b>Power Requirements</b>	115 or 230 VAC, 50/60 Hz
<b>Connector Type</b>	Customer specified

<b>Sensor VSWR</b>	1.05 max (32.2 dB return loss)
<b>Load VSWR</b>	1.1 max (26.4 dB return loss)
<b>Coolant</b>	100% water or 35% industrial ethylene glycol / 65% water, 9 quarts (8.5 liters), forced air cooling
<b>Particle Generation</b>	156 per cfm (0.5 µm) 29 per cfm (1 µm) 0 per cfm (3 µm)
<b>Casters</b>	4 locking swivel
<b>Material of Construction</b>	Stainless steel cart

## PHYSICAL

<b>Size</b>	39.5 in x 21.5 in x 39.5 in (100.3 cm x 54.6 cm x 100.3 cm)
<b>Weight</b>	240 lb (109 kg)

## ENVIRONMENTAL

<b>Operating Temperature</b>	5 °C to 30 °C (41 °F to 86 °F), < 25 kW, 100% water, (derate sensor accuracy outside 25 ±10 °C), 5 °C to 35 °C (41 °F to 95 °F), < 20 kW, 100% water, (derate sensor accuracy outside 25 ±10 °C)
<b>Storage Temperature</b>	0 °C to 25 °C (32 °F to 77 °F), < 25 kW, 35% ethylene glycol/65% water 0 °C to 35 °C (32 °F to 95 °F), < 20 kW, 35% ethylene glycol/65% water
<b>Humidity</b>	85% max (non-condensing)
<b>Altitude</b>	Load derated above 5,000 ft (1,524 m)

## CERTIFICATIONS

<b>CE</b>	CE Compliant
-----------	--------------



## RF Calibration Kit

### SMK-3000 SERIES

The SMK-3000 calibration kits are precision, high power calibration standards used to calibrate RF radios, wattmeters, directional couplers and other high-power RF test equipment in the field or metrology lab. Available in a single- or dual-sensor option, these kits provide a much faster time-to-calibration with lab precision and accuracy. Covering a frequency range of 1 to 1000 MHz, these kits enable users to calibrate at 3% accuracy in just minutes.

### KIT INCLUDES

- Low band Directional Power Sensor
- Medium band Directional Power Sensor
- High band Directional Power Sensor
- 4421A Multifunction Power Meter to display RF power readings with up to 3 % accuracy
- Rugged carrying case
- Latch & Lock cable



SMK-3000 SERIES	PRODUCT TYPE	FREQUENCY RANGE	ACCURACY	POWER RANGE
SMK-3003-LB	3% Kit	1 to 10 MHz	±3% of reading (2 $\sigma$ )	1 to 1000 W
SMK-3003-MB	3% Kit	10 to 100 MHz	±3% of reading (2 $\sigma$ )	1 to 1000 W
SMK-3003-HB	3% Kit	100 to 1000 MHz	±3% of reading (2 $\sigma$ )	1 to 1000 W

### MEASUREMENT

<b>Directivity</b>	28 dB minimum
<b>Impedance</b>	50 Ohms
<b>Insertion Loss</b>	< .05 dB
<b>Insertion VSWR</b>	< 1.05:1

### UNCERTAINTY

<b>Forward Power Uncertainty*</b>	SMK-3003A Series: ±3% of reading*, 2 $\sigma$ Calibration plane location: Connector output
<b>Reflected Power Uncertainty*</b>	±3% of reading*, 2 $\sigma$ Calibration plane location: Connector output
<b>VSWR Uncertainty</b>	-27 dB to -10 dB, see chart

\*Measurement conditions: Harmonics <35 dBc, Load VSWR <1.1:1, AM modulation <1%

### CONNECTORS

<b>RF Input</b>	N(m), Quick Change (QC)
<b>RF Output</b>	N(f), Quick Change (QC)
<b>Display</b>	1-meter Latch & Lock coiled cable

### ENVIRONMENTAL

<b>Operating Humidity</b>	20% to 50%
<b>Operating Temperature</b>	19.4 °C to 26.1 °C (73 °F to 6 °F)
<b>Storage Temperature</b>	-20 °C to 70 °C (-4 °F to 158 °F)

### PHYSICAL

<b>Weight</b> (excluding 4421A)	5 lb (2.27 kg)
------------------------------------	----------------





# RF POWER SENSORS

## Simple to Complex Power Measurement for Communications and Process Control

Bird provides power sensor solutions for virtually all types of RF applications. From simple true-average power measurement applications to complex waveforms associated with today's modern communication systems. Bird's plug and play solution provides an inline measurement that can be displayed on multiple types of devices providing basic power measurements, to highly accurate or statistical readings. You can rely on Bird sensor products to meet the needs of your unique applications.



**DIGITAL POWER METER DISPLAY**

Page 41



**WIDEBAND**

Page 42 -43



**BASIC**

Page 44



**STATISTICAL**

Page 45



**DIRECTIONAL**

Page 46 - 47

# Rugged Solutions for Measuring a Broad Range of Critical RF Parameters

Bird offers a comprehensive range of RF Sensors, meters and monitors, all easy-to-use solutions for users of all skill levels. The RF power sensors range from the economical, element based Directional Power Sensor to the multi-functional Wideband Power Sensor capable of measuring a broad range of critical RF parameters.

From simple true-average power measurement applications, to the measurement of the complex waveforms associated with modern communications systems, where peak power or burst power measurement are essential. All Bird RF Sensors are rugged, highly accurate, and provide high value power measurement solutions.

## 1 WHAT IS AN RF POWER SENSOR?

The most common RF transmitter measurement is RF power. Before performing any other tests, the engineer or technician will want to confirm that the source is outputting power, at the correct level. RF power is the first indication of a system's health.

Most power sensors fall into three categories: thermistors, thermocouples and diode detectors. Thermistors operate by changing resistance due to a change in temperature. The change in temperature is a result from converting RF energy into heat.

Thermocouples are heat-based sensors and are considered true averaging detectors. Thermocouples generate a voltage due to temperature differences at the junction of two dissimilar metals.

Diode detectors convert or rectifies an RF signal to DC with an amplitude that is proportional to the input power. For a certain range of power levels, a detector's output voltage is proportional to the square-root of power otherwise called the square-law range.

## 2 SIGNAL TYPES AFFECT MEASUREMENT UNCERTAINTY

For a radio signal to carry information, it must be varied or modulated - there are various types of modulation, each best in different situations. It is important to know what type of modulation is being measured since signal waveform effects measurement uncertainty.

RF modulation techniques are roughly divided into four types: Analog modulation, Digital modulation, Pulse modulation, and Spread spectrum method. Analog modulation is typically used for AM, FM radio, and short-wave broadcasting. Digital modulation involves transmission of binary signals (0 and 1) found in digital broadcast TV and radio, mobile communications, tactical military radios etc.

Among the types of RF power measurements, the steady state of a CW tone is perhaps the simplest. Peak power, such as the overshoot of an RF pulse or IQ waveform, is the maximum value over some period of time. The power measurement can be averaged across a time period, such as across a series of RF pulses, yielding the average power.

For many mobile communication signals, RF power can be integrated over a frequency band. Digitally modulated signals tend to be noise-like in nature and often have specified average and peak power values. A true averaging sensor will provide average power measurements for all types of signal formats from continuous wave (CW) to complex digital modulations.

### Amplitude Modulation (AM)

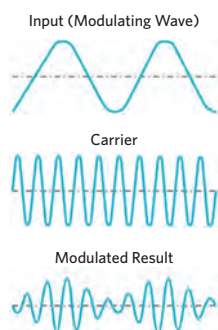

### Frequency Modulation (FM)

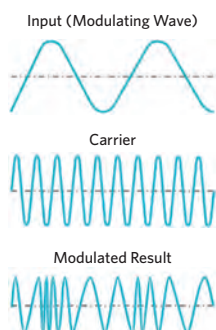

### Digital Modulation

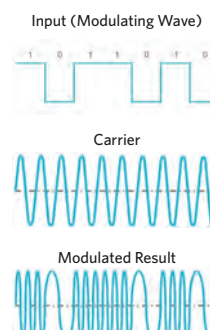

### 3 BASIC FACTORS TO CONSIDER WHEN SELECTING AN RF POWER SENSOR

- **Frequency Range:** the range of frequencies that the sensor will cover.
- **Dynamic Range:** the range of power over which a sensor is capable of making useful measurements.
- **Accuracy** of the measurement based on uncertainty factors
- **Zero Calibration Requirements**
- **Speed** of measurements

### 4 POWER SENSOR MEASUREMENTS

Choosing the right power sensor for your application is dependent on the signal characteristics you need to measure.

**True Average Power** is the RF power level independent of the waveform. The measurement is "true" regardless of whether the waveform is CW, AM, FM, PM, pulsed, has a large crest factor, or consists of some other complex waveform.

**Peak Power** measures the highest single power of a pulsed RF signal waveform. This is important for evaluating signals where peaks outside the pulse lead to distortion.

**Burst Average Power** are appropriate RF power measurements for GSM and TDMA signal waveforms. They are characterized by long pulse widths and long periods.

**Crest Factor** measures the ratio between average and peak RF power, in dB. If the crest factor is too large, the transmitter will not be able to handle the peak powers and amplitude

amplitude distortion will occur. Crest factor can also detect overdrive and overshoot problems.

**CCDF (Duty Cycle)** is a statistical characterization of the time-domain waveform that completely describes the power characteristics of the signal. A CCDF graph relates average signal power (X axis) to signal power statistics (Y axis) such that each point on the CCDF curve shows how much time a signal spends at or above a given power level. The power level is expressed in dB relative to the average signal power level.

**Statistical Signal Analysis (7022 Series Only)** provides the statistical measurement capability required to accurately characterize modern communications system waveforms independent of the modulation technique or channel access method used in the system.

### 5 HOW TO DISPLAY YOUR DATA

Most RF power sensors are used in conjunction with a separate power meter or software. Bird offers the following options for measurement viewing; 5000-NG, VPM3, RF Meter App for Android and Windows. Whether you are using a PC or a stand-alone meter, you can view data logging, power versus time graphs, and offset table that enable quick and accurate measurements.

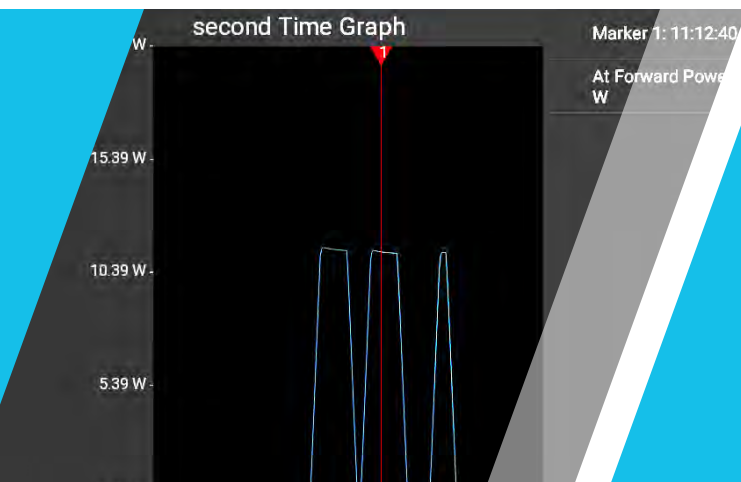

Discover  
RF with Bird



## RF Power Meter Display

### 5000-NG

Bird's new 5000-NG RF Power Meter Display provides another dimension for viewing your RF power meter measurements when connected to Bird's Power Sensors. Operating over a broad frequency range using one of Bird's USB RF power sensors, the 5000-NG allows you to instantly view measurements like True Average Power, VSWR, Return Loss, and more. A giant leap forward, this unit delivers high quality interface and RF power measurements at your fingertips for installation and maintenance both on the go or in an R & D lab environment.

#### MEASUREMENT

<b>Frequency Range</b>	2 MHz to 6 GHz with external power sensors (not included)
<b>Key Measurements</b>	True Average Power (Forward and Reflected), VSWR, Return Loss, rho, Match Efficiency, Peak Power, Peak to Average Ratio, PEP, Crest Factor, Burst and Burst Average Power, CDF, CCDF, Confidence %, IEEE 194 Pulse Parameters, Sensor Temperature

#### CONNECTORS

<b>USB</b>	Micro USB PC interface & charging and Standard USB power sensor interface
------------	---

#### SYSTEM

<b>Display</b>	Full-Color 8" 1280 x 800-pixel display w/backlight
<b>Operating System</b>	Android 5.1
<b>Languages</b>	English
<b>Storage</b>	16 GB
<b>Data Transfer</b>	USB drive, PC, WiFi, or Bluetooth
<b>Battery Type</b>	Rechargeable, 3.7 V/6200 mAh lithium

<b>Battery Operating Time</b> (display in sleep mode)	24 hrs. continuous usage w/5012 Series or 7022 sensors, 48 hrs. continuous usage w/all other sensors
<b>Battery Charge Time</b>	6 hours typical
<b>Recommended Calibration Interval</b>	No calibration required (sensor calibration recommended)
<b>Power Supply</b>	AC: 100 to 240 V / 50-60 Hz; DC: 5V/2.5 A
<b>Upgradeability</b>	Firmware field-upgradeable via USB port
<b>Additional Functions</b>	Data logging, numerical & graphing display
<b>Sensor Detection</b>	Automatic USB Sensors WiFi 802.11 Network

#### ENVIRONMENTAL

<b>Operating Temperature</b>	-20 °C to 60 °C (-4 °F to 140 °F)
<b>Storage Temperature</b>	-20 °C to 80 °C (-4 °F to 176 °F)
<b>Altitude</b>	Up to 15,000 ft (4,572 m)

#### PHYSICAL

<b>Size</b>	9.2 in x 6.3 in x 1.1 in (233 mm x 160 mm x 28 mm)
<b>Weight</b>	1.3 lb (0.59 kg)

#### PRODUCT FEATURES

- Rugged, 8" color touch screen display for worry-free field use
- Automatic sensor detection that works with over 10 supported Bird USB field sensors
- Data logging, 7-day memory
- 48 hours of battery life for extended use
- Android 5.1 operating system provides enhanced security
- 5.0 Megapixel camera
- Tried and true power measurement with simple set-up
- Data logging, numerical & graphics display
- Easy data transfer via USB or WiFi

#### KEY MEASUREMENTS WHEN PAIRED WITH A BIRD POWER SENSOR

- True Average Power (Forward and Reflected)
- VSWR, Return Loss, rho, Match Efficiency
- Peak Power, Peak to Average Ratio, Crest Factor, PEP
- Burst and Burst Average Power
- CDF, CCDF, Confidence %
- IEEE 194 Pulse Parameters
- Sensor Temperature

#### COMPATIBLE SENSORS

<b>5012D</b>	Wideband Power Sensor, 350 MHz to 4 GHz, 150 mW to 150 W, 400 W Peak
<b>5014</b>	Directional Power Sensor, 2 MHz to 2.7 GHz, 125 mW to 1 kW, Full scale
<b>5016D</b>	Wideband Power Sensor, 350 MHz to 4.0 GHz, 25 mW to 25 W, 60 W Peak
<b>5017D</b>	Wideband Power Sensor, 25 MHz to 1.0 GHz, 500 mW to 500 W, 1300 W Peak
<b>5018D</b>	Wideband Power Sensor, 150 MHz to 4.0 GHz, 100 mW to 25 W, 60 W Peak
<b>5019D</b>	Wideband Power Sensor, 25 MHz to 1.0 GHz, 100 mW to 100 W, 250 W Peak
<b>7020-1-010101</b>	Wideband Power Sensor, 350 MHz to 4.0 GHz, 150 mW to 150 W
<b>7020-1-020101</b>	Wideband Power Sensor, 350 MHz to 4.2 GHz, 150 mW to 150 W
<b>7020-1-030301</b>	Wideband Power Sensor, 25 MHz to 1.0 GHz, 500 mW to 500 W
<b>7022-1-020201</b>	Wideband Power Sensor, 350 MHz to 6.0 GHz, 250 mW to 500 W





**PRODUCT FEATURES**

- Digital, analog, and multi-carrier signals regardless of modulation type
- Measures True Average Power, Peak Power and Duty Cycle directly with exceptional accuracy
- Calculations performed: VSWR, Return Loss, Reflection Coefficient, Crest Factor, Average Burst Power and CCDF
- Sensor plug and plays with 5000-NG Power Meter Display and Bird's RF Meter App

**BENEFITS**

- Monitor and perform maintenance for monitoring while DUT (Device Under Test) is in-service
- No field calibration required, annual factory calibration only

**SUPPORTED MODULATIONS**

- Wide coverage of applications: WPS measures: Analog Cellular, Digital Cellular, 3G, 4G, Tetra, APCO/P25, Trunking, CDMA, TDMA, WCDMA, GSM, Transportation, Tactical Military, Radar, Avionics, Marine, LMR, Analog Broadcast, Digital Broadcast, GSM, GPRS, EDGE, UMTS, HSDPA, Bluetooth, Fire, GPS, NPSPAC, Paging, Project 25, Public Safety, Telematics, Utilities, WIMAX and WLAN

**Wideband Power Sensors**

**5012D, 5016D, 5017D, 5017D-AV, 5018D, 5019D**

**±4% ACCURACY**

Bird's Wideband Power Sensor Series provides high performance and accurate in-line field measurements that never require field calibration. These Thruline sensors can measure average, peak, or burst power, VSWR, crest factor, and Complementary Cumulative Distribution Function (CCDF). They can be used with Bird's 5000-NG Power Meter Display, Site Analyzers, SignalHawk, Bird's Virtual Power Meter Software(VPM3) and the Bird's RF meter App.

	5012D	5016D	5017D	5017D-AV	5018D	5019D
<b>Frequency Range</b>	350 MHz to 4.0 GHz	350 MHz to 4.0 GHz	25 MHz to 1.0 GHz	100 MHz to 1.3 GHz	150 MHz to 4.0 GHz	25 MHz to 1.0 GHz
<b>Power Range</b>	150 mW to 150 W Avg 400 W Peak	25 mW to 25 W Avg 60 W Peak	500 mW to 500 W Avg 1300 W Peak*	500 mW to 500 W Avg 1300 W Peak*	100 mW to 25 W Avg 60 W Peak	100 mW to 100 W 260 W Peak
<b>Insertion VSWR</b>	<1.05 from 0.35 to 2.5 GHz <1.10 from 2.5 to 4 GHz	<1.05 from 0.35 to 2.5 GHz <1.10 from 2.5 to 4 GHz	<1.05	<1.05	<1.05 from 0.15 to 2.5 GHz <1.10 from 2.5 to 4 GHz	<1.05
<b>Insertion Loss</b>	<0.05 dB from 0.35 to 1.0 GHz <0.1 dB from 1 to 4 GHz	<0.05 dB from 0.35 to 1.0 GHz <0.1 dB from 1 to 4 GHz	<0.05 dB	<0.1 dB	<0.05 dB from 0.35 to 1.0 GHz <0.1 dB from 1 to 4 GHz	<0.05 dB
<b>Directivity</b>	30 dB up to 3.0 GHz, 28 dB from 3.0 to 4.0 GHz	30 dB up to 3.0 GHz, 28 dB from 3.0 to 4.0 GHz	29 dB 25 MHz to <50 MHz 30 dB from >50 MHz to 1000 MHz	28 dB up to 100 MHz, 30 dB from 100 to 1000 MHz	30 dB up to 3.0 GHz, 28 dB from 3.0 to 4.0 GHz	28 dB up to 100 MHz, 30 dB from 100 to 1000 MHz

\*Derate maximum average power rating from 500 W at 300 MHz to 100 W at 1 GHz using a straight line on a log-log scale

**SYSTEM**

<b>Power Supply</b>	USB Port: Less than one low-power, USB load DC Input Connector: 7-18, VDC at less than 0.1A
<b>Impedance</b>	50 Ohms nominal
<b>Data Logging</b>	Requires 5000-NG or VPM3

**CONNECTORS / INTERFACES**

<b>Connectors</b>	N Female (Both)
<b>DPM</b>	DB9 proprietary interface
<b>PC Interface (1)</b>	RS-232, 9600 Baud, no parity, 8 data bits, 1 stop bit, DB9
<b>PC Interface (2)</b>	USB 2.0 Type B

**ENVIRONMENTAL**

<b>Operating Temperature</b>	-10 °C to 50 °C (14 °F to 122 °F)
<b>Storage Temperature</b>	-40 °C to 80 °C (-40 °F to 176 °F)

**PHYSICAL**

<b>Size</b>	4.8 in x 4.6 in x 1.3 in (120 mm x 82 mm x 97 mm)
<b>Weight</b>	1.2 lb (.54 kg)

**CERTIFICATIONS**

<b>CE</b>	EMC EN 61326-1-2006
<b>Mechanical Shock &amp; Vibration</b>	IAQ MIL-PRF-28800F class3

**STANDARD ACCESSORIES**

<b>5A2653-10</b>	USB Cable
<b>VPM3</b>	Virtual Power Meter
<b>920-50125</b>	Instruction Book
<b>920-VPM3</b>	VPM Instruction Book

**OPTIONAL ACCESSORIES**

<b>PA-MNME</b>	Male N to Male 7/16 (DIN)
<b>PA-MNFE</b>	Male N to Female 7/16 (DIN)
<b>5A2226</b>	Power Supply, Intl
<b>5A2229</b>	Power Supply, US
<b>5A2264-09-MF-10</b>	DB9 Cable, 10 in
<b>5A2653-0R5NL5</b>	USB Interface Cable, 15 cm

## Wideband Power Sensors 5012D, 5016D, 5017D, 5017-AV, 5018D, 5019D

### AVERAGE POWER

MODEL	AVERAGE FORWARD POWER RANGE	PEAK POWER RANGE	ACCURACY, AVERAGE FORWARD POWER	MINIMUM FORWARD POWER FOR REFLECTED MEASUREMENT	RETURN LOSS	VSWR
5012D	150 mW to 150 W	400 W Peak	±4% of reading, + 0.05 W	0.5 W	0.0 to 23 dB	1.15 to 99.9
5016D	25 mW to 25 W	60 W Peak	±4% of reading, + 0.008 W	0.1 W	0.0 to 23 dB	1.15 to 99.9
5017D/5017D-AV*	500 mW to 500 W	1300 W Peak	±4% of reading, + 0.17 W	0.5 W	0.0 to 23 dB	1.15 to 99.9
5018D	100 mW to 25 W	60 W Peak	±4% of reading, + 0.008 W	0.1 W	0.0 to 23 dB	1.15 to 99.9
5019D	100 mW to 100 W	260 W Peak	±4% of reading, + 0.04 W	0.3 W	0.0 to 23 dB	1.15 to 99.9

\*Derate maximum average power rating from 500 W at 300 MHz to 100 W at 1GHz using a straight line on a log-log scale

### BURST AVERAGE POWER

MODEL	BURST AVERAGE POWER RANGE	BURST WIDTH	REPETITIONS RATE	DUTY CYCLE (D)	ACCURACY, BURST AVERAGE POWER
5012D	4 W to 150 W avg	1 $\mu$ s to 5 ms	5 Hz, Min	.002 to 1.0	±6% of reading, + 0.05 W
5016D	.7 W to 25 W avg	1 $\mu$ s to 5 ms	5 Hz, Min	.002 to 1.0	±6% of reading, + 0.008 W
5017D/5017D-AV	13.5 W to 500 W avg	1 $\mu$ s to 5 ms	5 Hz, Min	.002 to 1.0	±6% of reading, + 0.17 W
5018D	.7 W to 25 W avg	1 $\mu$ s to 5 ms	5 Hz, Min	.002 to 1.0	±6% of reading, + 0.008 W
5019D	2.7 W to 100 W avg	1 $\mu$ s to 5 ms	5 Hz, Min	.002 to 1.0	±6% of reading, + 0.04 W

### PEAK ENVELOPE POWER & ACCURACY\*\*

MODEL	PEAK ENVELOPE POWER RANGE	BURST WIDTH > 200 MS	1 MS < BURST WIDTH < 200 MS	0.5 MS < BURST WIDTH < 1 MS	BURST WIDTH < 0.5 MS
5012D	4 W to 400 W	±7% of reading, + 0.20 W	±10% of reading, + 0.40 W	±15% of reading, + 0.40 W	±20% of reading, + 0.40 W
5016D	.7 W to 60 W	±7% of reading, + 0.05 W	±10% of reading, + 0.10 W	±15% of reading, + 0.10 W	±20% of reading, + 0.10 W
5017D/5017D-AV	13.5 W to 1300 W	±7% of reading, + 0.70 W	±10% of reading, + 1.40 W	±15% of reading, + 1.40 W	±20% of reading, + 1.40 W
5018D	.7 W to 60 W	±7% of reading, + 0.05 W	±10% of reading, + 0.10 W	±15% of reading, + 0.10 W	±20% of reading, + 0.10 W
5019D	2.7 W to 260 W	±7% of reading, + 0.13 W	±10% of reading, + 0.26 W	±15% of reading, + 0.26 W	±20% of reading, + 0.26 W

\*\*For temperatures above 35 °C or below 15 °C add 3.0% to stated accuracies

### COMPLEMENTARY CUMULATIVE DISTRIBUTION FUNCTION (CCDF)

MODEL	CCDF MEASUREMENT RANGE	THRESHOLD MEASUREMENT RANGE	MEASUREMENT UNCERTAINTY	LEVEL SET ACCURACY
5012D	0.1 to 100%	4.0 W to 400 W	±2%	As Peak Envelope Power Accuracy + 2.0%
5016D	0.1 to 100%	0.7 W to 25 W	±2%	As Peak Envelope Power Accuracy + 2.0%
5017D/5017D-AV	0.1 to 100%	13.5 W to 500 W	±2%	As Peak Envelope Power Accuracy + 2.0%
5018D	0.1 to 100%	0.7 W to 25 W	±2%	As Peak Envelope Power Accuracy + 2.0%
5019D	0.1 to 100%	2.7 W to 100 W	±2%	As Peak Envelope Power Accuracy + 2.0%

### CREST FACTOR

MODEL	CREST FACTOR MEASUREMENT RANGE	ACCURACY, CREST FACTOR
5012D	150 mW to 150 W	Linear Sum of Peak and Average Power Accuracies
5016D	25 mW to 25 W	Linear Sum of Peak and Average Power Accuracies
5017D/5017D-AV	500 mW to 25 W	Linear Sum of Peak and Average Power Accuracies
5018D	25 mW to 25 W	Linear Sum of Peak and Average Power Accuracies
5019D	100 mW to 100 W	Linear Sum of Peak and Average Power Accuracies



## PRODUCT FEATURES

- Digital, analog, and multi-carrier signals regardless of modulation type
- Measures forward and reflected power and VSWR to troubleshoot system failures
- Monitor and perform maintenance for monitoring while DUT(Device Under Test) is in-service
- Economical power measurement solution
- Utilizes the complimentary Virtual Power Meter (VPM3) application
- Supported by 5000-NG Power Meter Display
- No field calibration required

## SUPPORTED MODULATIONS

- Wide coverage of applications: Analog Cellular, Digital Cellular, 3G, 4G, Tetra, APCO/P25, Trunking, CDMA, TDMA, WCDMA, GSM, Transportation, Tactical Military, Radar, Avionics, Marine, LMR, Analog Broadcast, Digital Broadcast, GSM, GPRS, EDGE, UMTS, HSDPA, Bluetooth, Fire, GPS, NPSPAC, Paging, Project 25, Public Safety, Telematics, Utilities, WIMAX and WLAN

## Basic Power Sensors

### 7020 SERIES

±4% ACCURACY

The 7020 Series of RF Power Sensors is an economical, plug and play solution to your power measurement needs. The 7020 determines and reports Forward and Reflected True Average Power and VSWR over a wide frequency range of 25 MHz to 1.0 GHz or 350 MHz to 4.2 GHz. It also never requires field calibration, only requires factory calibration once per year and is traceable to National Institute of Standards and Technology (NIST).

	7020-1-030301	7020-1-010101	7020-1-020101
<b>Frequency Range</b>	25 MHz to 1.0 GHz	350 MHz to 4.0 GHz	350 MHz to 4.2 GHz
<b>Power Range</b>	0.5 W to 500 W*	0.15 W to 150 W	0.15 W to 150 W

\*Derate maximum average power rating from 500 W at 300 MHz to 100 W at 1 GHz using a straight line on a log-log scale.

### MEASUREMENT

<b>Accuracy</b>	±4% of reading + 0.05 W Add 3% to uncertainty above 35 °C or below 15 °C
<b>Forward Power for Reflected Measurement</b>	5.0 W min
<b>Peak/Average Ratio</b>	12 dB max
<b>Insertion Loss</b>	0.1 dB max
<b>Insertion VSWR</b>	1.10 max
<b>VSWR Range</b>	1.15 to 99.9
<b>Impedance</b>	50 Ohms nominal
<b>Response Time</b>	100 ms
<b>PIM Rating</b>	-130 dBc @ 460 MHz
<b>Directivity</b>	<-30 dB, 350 to 1000 MHz min <-28 dB, 1000 to 4000 MHz min <-24 dB, 4000 to 6000 MHz min

### CONNECTORS

<b>RF Connectors</b>	N Female
<b>Display Interface</b>	USB 2.0 Type 'B' with "SeaLATCH" locking USB connector

### SYSTEM

<b>Recommended Calibration Interval</b>	1 year
<b>Power Supply</b>	5 VDC from USB host, 35 mA current draw
<b>Data Logging</b>	with VPM3 software
<b>Upgradeability</b>	Firmware field-upgradeable via the USB port

### ENVIRONMENTAL

<b>Operating Temperature</b>	-30 °C to 60 °C (-22 °F to 140 °F)
<b>Storage Temperature</b>	-40 °C to 80 °C (-40 °F to 176 °F)
<b>Humidity</b>	95% max (non-condensing)
<b>Altitude</b>	Up to 15,000 ft (4,572 m)

### PHYSICAL

<b>Size</b>	4.8 in x 2.6 in x 1.3 in (122 mm x 66 mm x 32 mm)
<b>Weight</b>	1 lb (0.45 kg)

### CERTIFICATIONS

<b>CE</b>	EMC Directive (2004/108/EC): European Standard EN 61326-1:2006 – Electronic Equipment for measurement, control and laboratory use  EMC Requirements: in accordance with EMC Directive (2004/108/EC)
<b>RoHS</b>	Compliant
<b>Mechanical Shock &amp; Vibration</b>	Mil-PRF-28800F Class 3

### STANDARD ACCESSORIES

<b>5A2653-6L2</b>	SeaLATCH USB Cable
<b>VPM3</b>	Virtual Power Meter
<b>920-7020S</b>	Instruction Manual (Sensor)
<b>920-VPM3</b>	Instruction Manual (VPM3)

### COMPATIBLE DEVICES

<b>5000-NG</b>	Digital Power Meter Display
<b>Bird RF Meter</b>	Android App



MADE IN USA

## Statistical Power Sensor

7022-1-020201

±3% ACCURACY

The 7022-1-020201 Statistical RF Power Sensor is a rugged, easy to use field instrument that uses statistical sampling techniques. In modern communications, signal average power, although important is no longer a sufficient control variable. These communication signals often require more diagnostic measurements. In the statistical mode, the power sensor measures the percentage of time the signal exists at a specific peak-to-average ratio. In the time domain mode, the sensor adds a variety of functions similar to an oscilloscope to our standard suite of measurements.

### MEASUREMENT

<b>Measurement Type</b>	ThruLine Power
<b>Frequency Range</b>	350 MHz to 6 GHz
<b>Frequency Measurement Accuracy</b>	±3% of reading with CW signals
<b>Power Measurement Range*</b>	0.25 W to 500 W average, 1500 W peak
<b>Dynamic Range</b>	33 dB
<b>Peak to Average Ratio</b>	12 dB, absolute peak power limited to 1500 W
<b>Impedance</b>	50 Ohms nominal
<b>Insertion Loss</b>	0.05 dB max
<b>Insertion VSWR</b>	1.065, 350 to 2500 MHz max 1.12, 2500 to 6000 MHz max
<b>Directivity, Min</b>	<-30 dB, 350 to 1000 MHz, <-28 dB, 1000 to 6000 MHz <-24 dB, 4000 to 6000 MHz (min)

\*Derate maximum average power rating from 500 W at 350 MHz to 100 W at 6 GHz using a straight line on a log-log scale.

### CONNECTORS

<b>RF Connectors</b>	N Female
<b>Display Interface</b>	USB 2.0 Type B (USBTMC)
<b>Trigger Input</b>	BNC female (1MΩ Impedance; 3 V High, 1.2 V Low)

### SYSTEM

<b>Factory Calibration</b>	NIST traceable
<b>Field Calibration</b>	No field calibration required
<b>Data Logging</b>	Yes, with the VPM3 software
<b>Power Supply</b>	USB Port
<b>Sample Rate</b>	44 M samples/s max
<b>Time Resolution</b>	50 nSec to 10 Sec
<b>Time Base Accuracy</b>	.01%
<b>Display Refresh Rate</b>	10 times/sec (Limited by communication)
<b>Video Bandwidth</b>	Settable: 20 MHz (none), 5 MHz, 400 kHz, 4.5 kHz
<b>Points per screen</b>	1001 max

### ENVIRONMENTAL

<b>Operating Temperature</b>	-10 °C to 50 °C (14 °F to 122 °F)
<b>Storage Temperature</b>	-40 °C to 80 °C (-40 °F to 176 °F)
<b>Humidity</b>	95% max (non-condensing)
<b>Altitude</b>	Up to 15,000 ft (4,572 m)

### PHYSICAL

<b>Size</b>	5.8 in x 4.8 in x 1.3 in (147 mm x 122 mm x 33 mm)
<b>Weight</b>	1.5 lb (0.68 kg)

## PRODUCT FEATURES

- Digital, analog, and multi-carrier signals regardless of modulation type
- Provides Forward and Reflected Power, Peak/Pulse Power, Time Domain and Statistical Measurements
- Three operating modes: Conventional Time Domain and Statistical
- Analytical results of Signal of Interest using CCDF parameters
- Detailed breakdown of a single or multiple pulses
- Isolate and identify specific breakpoints with the use of markers
- Includes a wide range of IEEE pulse parameters

## APPLICATIONS

- Analog Cellular, Digital Cellular, 3G, 4G, Tetra, APCO/P25 Phase 1 & 2, DMR, MOTOTRBO, Trunking, CDMA, TDMA, WCDMA, GSM, Transportation, Tactical Military, Radar, Avionics, Marine, LMR, Analog Broadcast, Digital Broadcast, GSM, GPRS, EDGE, UMTS, HSDPA, Bluetooth, Fire, GPS, NPSPAC, Paging, Public Safety, Telematics, Utilities, WIMAX, WLAN, EVDO, UMTS, LTE, and HDT

### CERTIFICATIONS

<b>CE</b>	EMC Directive (2004/108/EC): European Standard: EN 61326 - Electrical Equipment for measurement, control and laboratory use
<b>Mechanical Shock &amp; Vibration</b>	Mil-PRF-28800F Class 3
<b>RoHS</b>	Compliant

### STANDARD ACCESSORIES

<b>5A2653-6L2</b>	USB SeaLatch™ Cable
<b>VPM3</b>	Virtual Power Meter
<b>920-7022</b>	Manual for Statistical Power Sensor
<b>920-VPM3</b>	Manual for Virtual Power Meter
<b>5A2918-11-6</b>	BNC / BNC Trigger Cable





## PRODUCT FEATURES

- Bird's Directional Power Sensor measures True Average Power using APM/DPM elements
- Measure Peak Power using 43 Series elements.
- Supported modulation types include: AM, FM, CW, 8VSB, COFDM
- Provides Forward & Reflected RF power, VSWR, Return loss, Reflection Coefficient
- Operate your sensor by connecting USB cable to an Android device utilizing the Bird RF Meter app, power meter display (5000-NG), or VPM3 on a windows 7 PC. (Windows RF Meter Software for newer OS)
- Virtual Power Meter (VPM3) included

## Directional ThruLine Power Sensors

5014

±5% ACCURACY

The Bird 5014 directional power sensor is a flexible power measurement solution that can be tailored to a multitude of applications. Measures True Average Power or Peak Power using Bird elements.

No field calibration is required and factory calibration is only suggested once per year. Calibration is traceable to the National Institute of Standards and Technology (NIST), providing additional confidence in your RF measurements.

## COMPATIBLE DEVICES

5000-NG	SH-60S-TC
SK-4500-TC	SH-60S-AOA
SK-6000-TC	VPM3
RF Meter App	Windows 10

### MEASUREMENT

<b>Frequency Range</b>	Element dependent, 2 MHz to 1000 MHz
<b>Power Range</b>	Element dependent, 125 mW to 1 kW full
<b>Accuracy</b>	True Average Power: ±5% of reading (15 °C to 35 °C); ±7% of reading (-10 °C to 50 °C) Peak Power: ±8% of full scale
<b>Peak/Average Ratio</b>	10 dB maximum with DPM elements
<b>Insertion VSWR</b>	1.05:1 from 0.45 to 1000 MHz (with N connectors)
<b>Impedance</b>	50 Ohms
<b>Directivity</b>	30 dB typical (element dependent)

<b>Dynamic Range</b>	16 dB
<b>Pulse Width Parameters</b>	>100 MHz: 800 ns minimum 26 to 99 MHz: 1.5 µs minimum 2 to 25 MHz: 15 µs minimum
<b>Pulse Rep. Rate Peak</b>	15 pps minimum
<b>Pulse Duty Factor</b>	1 x 10 <sup>-4</sup> minimum

### CONNECTORS

<b>RF Connectors</b>	QC Type. Female N normally supplied
<b>Display Interface</b>	5014: USB 1.1 Type 'B'

### SYSTEM

<b>Settling Time</b>	<2.5 seconds
<b>Recommended Calibration Interval</b>	1 year
<b>Power Supply</b>	From host instrument via cable connection

### ENVIRONMENTAL

<b>Operating Temperature</b>	-10 °C to 50 °C (14°F to 122 °F)
<b>Storage Temperature</b>	-40 °C to 75 °C (-40 °F to 167 °F)
<b>Humidity</b>	95% max (non-condensing)

### PHYSICAL

<b>Size (excluding connectors)</b>	2.3 in x 2.1 in x 3.5 in (58 mm x 53 mm x 89 mm)
<b>Weight</b>	1.12 lb (0.51 kg)

# Directional Thruline Power Sensors

5014

## DPM ELEMENT SELECTION GUIDE

FREQUENCY RANGE	FORWARD POWER RANGE	REFLECTED POWER RANGE	FORWARD ELEMENT	REFLECTED ELEMENT
25 to 60 MHz	1.25 to 50 W 12.5 to 500 W	125 mW to 5 W 1.25 to 50 W	DPM-50A DPM-500A	DPM-5A DPM-50A
50 to 125 MHz	1.25 to 50 W 12.5 to 500 W 25 to 1.0 kW	125 mW to 5 W 1.25 to 50 W 25 to 100 W	DPM-50B DPM-500B DPM-1000B	DPM-5B DPM-50B DPM-100B
100 to 250 MHz	1.25 to 50 W 12.5 to 500 W 62.5 to 2.5 kW	125 mW to 5 W 1.25 to 50 W 6.25 to 250 W	DPM-50C DPM-500C DPM-2500C	DPM-5C DPM-50C DPM-250C
200 to 500 MHz	125 mW to 5 W 1.25 to 50 W	12.5 mW to 500 mW 125 mW to 5 W 1.25 to 50 W	DPM-5D DPM-50D	DPM-5D DPM-5D DPM-50D
400 to 800 MHz	125 mW to 5 W 1.25 W to 50 W 2.5 W to 100 W 12.5 W to 500 W 25 W to 1 kW	125 mW to 5 W 250 mW to 10 W 1.25 W to 50 W	DPM-5E-400 DPM-50E-400 DPM-100E-400 DPM-500E-400 DPM-1000E-400	DPM-5E-400 DPM-10E-400 DPM-50E-400
800 to 1000 MHz	125 mW to 5 W 1.25 W to 50 W 2.5 W to 100 W 12.5 W to 500 W 25 W to 1 kW	12.5 mW to 500 mW 125 mW to 5 W 250 mW to 10 W 1.25 W to 50 W 2.5 W to 100 W	DPM-5E-800 DPM-50E-800 DPM-100E-800 DPM-500E-800 DPM-1000E-800	DPM-5E-800 DPM-5E-800 DPM-10E-800 DPM-50E-800 DPM-100E-800

Note: Elements must be chosen from the same series and the forward and reflected elements chosen in a 10:1 power ratio

## APM ELEMENT SELECTION GUIDE

POWER RANGE	FREQUENCY BANDS (MHz)						
	2 to 30	25 to 60	500 to 125	100 to 250	200 to 500	400 to 800	800 to 960
1 W	—	—	APM-1B	APM-1C	—	APM-1E-400	APM-1E-800
2.5 W	—	—	APM-2.5B	—	APM-2.5D	APM-2.5E-400	APM-2.5E-800
5 W	APM-5H	APM-5A	APM-5B	APM-5C	APM-5D	APM-5E-400	APM-5E-800
10 W	—	APM-10A	APM-10B	APM-10C	APM-10D	APM-10E-400	APM-10E-800
25 W	—	—	APM-25B	APM-25C	APM-25D	APM-25E-400	APM-25E-800
50 W	—	—	—	APM-50C	APM-50D	APM-50E-400	APM-50E-800
100 W	APM-100H	APM-100A	APM-100B	APM-100C	APM-100D	APM-100E-400	APM-100E-800
250 W	APM-250H	APM-250A	APM-250B	APM-250C	APM-250D	APM-250E-400	APM-250E-800
500 W	—	—	APM-500B	APM-500C	APM-500D	APM-500E-400	APM-500E-800
1000 W	APM-1000H	—	APM-1000B	APM-1000C	—	—	—

Note: Elements must be chosen from the same series and the forward and reflected elements chosen in a 10:1 power ratio

## 43 SERIES ELEMENT SELECTION GUIDE

- Select from Element Tables 1,2,3,4,6,13, and 14 starting on page 74
- 43 series elements can be used to measure average power if peak to average ratio is close to 1



# RF POWER MONITORS

## Monitor, Measure and Protect Your RF System

Bird's RF Power Monitor family includes a range of products that not only measure forward and reflected power and VSWR, but also provide hard contact alarms to protect your system in the event of a system failure. Depending on which system you need, the monitoring device can be configured to allow you to take control of the RF network installation from transmitters to the antenna.



**CHANNEL POWER MONITORS**

Page 51 - 53



**BROADCAST POWER MONITOR**

Page 54 - 55



**RF MONITORS & ALARMS**

Page 56 - 57



# RF Power Monitors

Anyone responsible for a multiple-site, multiple-channel land mobile radio communications system knows that management of even just a single site can often be a complex task. Failures or degradation in performance multiple trips to the site to correct the issue.

Bird's RF Power Monitors includes a range of products that not only measure power and VSWR but also provide hard contact alarms, logging, and remote monitoring to protect your system in the event of a system failure.

Remote 24/7 monitoring of transmitter RF power output and antenna performance in multi-channel and trunked radio networks allow you to efficiently monitor the performance of transmitters, transmission lines, and antennas at many remote sites.

## 1 WHAT ARE THE VARIOUS COMPONENTS WITHIN A COMMUNICATIONS SYSTEM THAT NEED TO BE MONITORED?

**Transmitter output monitoring** - Identify radios with reduced output. Monitoring will allow repair or replacement prior to failure

**Isolator performance** - Identify isolator degradation leading to an increase in reflected power that may harm the transmitter

**Combiner loss by channel** - Identify increases in insertion loss due to combiner detuning or drifting

**Antenna VSWR by channel** - Detailed monitoring of the antenna to identify frequency related VSWR shifts due to weather, aging, etc.

**Composite antenna VSWR** - Identify failures in the post combiner feedline or antenna

## 2 TYPE OF COMMUNICATION AND ALERTS

Determining the type of communication is required to manage a site is dependent on the type of system you choose. Here are some typical ways that sensors and monitoring devices can communicate feedback on the health of your system.

- **Local User Interface** - This typically is a local rack panel that provides setup and configuration menu's, and diagnostic screens.
- **Web Server management** - Webpage dedicated for setup and display of all measurement parameters and alarm functions
- **Data files** that can be logged and exported to view historical information and perform trend analysis
- **Configurable alarms** - alarm levels are settable by the user, locally or remotely
- **SNMP Enabled with traps** for end user interface with an SNMP management system

## 3 WHAT ARE SOME QUESTIONS YOU SHOULD ASK WHEN SELECTING YOUR COMMUNICATION SYSTEM?

Whether you need a Broadcast solution to change over from analog to digital signals or need to monitor radio performance, combiner loss and antenna/feedline characteristics, we have a solution for you.

- How many antennas will I have? How many sites?
- What is the provided input voltage at the site/sites?
- What type of network connection do I have? Cellular, Ethernet?
- Do you have an SNMP Manager?
- What are the frequencies I need to measure?
- How much power am I measuring?



## POWER MONITOR SELECTION GUIDE

	CPM	BPME
<b>Product Family</b>	Channel Power Monitors	Broadcast RF Power Monitors
<b>Measurement Types</b>	Monitors radio performance, combiner loss and antenna feedline characteristics	Used to measure and monitor VSWR and power
<b>Application</b>	Provide the user with continuous information by utilizing hard contact and SNMP formats	Monitor RF power and VSWR continuously and set alarms
<b>Data Access</b>	Serial or Ethernet	RS-232 or Ethernet
<b>Market</b>	16 channels analog or digital land mobile radio systems	Broadcast Solution
<b>Interface</b>	Built in Web Server or Panel Access	Display Panel or PC

## POWER SENSOR SELECTION GUIDE

	4042	4042E	4043	4043E	4044
<b>Type</b>	Channel, Directional	Channel, Directional	Composite, Directional	Composite, Directional	Non-Directional
<b>Frequency Range</b>	100 MHz to 1 GHz 30 MHz to 200MHz	100 MHz to 1 GHz	118 MHz to 940 MHz (Model Dependent)	118 MHz to 940 MHz (Model Dependent)	118 MHz to 940 MHz (Model Dependent)
<b>Measurement Range- FWD Power</b>	10 W to 500 W	10 W to 500 W	25 W to 500 W 2.5 W to 50 W(LP)*	25 W to 500 W 2.5W to 50 W(LP)*	2.5 W to 125 W
<b>Measurement Range- RFL Power</b>	1 W to 50 W	1 W to 50 W	2.5 W to 50 W .25 W to 5 W(LP)*	2.5 W to 50 W .25 W to 5 W(LP)*	N/A
<b>Measurement Accuracy</b>	±5% of reading	±5% of reading	±5% of reading	±5% of reading	±5% of reading
<b>Channel Bandwidth</b>	6.25, 12.5, 25 kHz selectable	6.25, 12.5, 25 kHz selectable	N/A	N/A	N/A
<b>Connector Options</b>	01 = N(f) 02 = N(m) 03 = 4.3/10(f) 04 = 4.3/10(m) 05 = 7/16 DIN(f) 06 = 7/16 DIN(m)	01 = N(f) 02 = N(m) 03 = 4.3/10(f) 04 = 4.3/10(m) 05 = 7/16 DIN(f) 06 = 7/16 DIN(m)	01 = N(f) 02 = N(m) 03 = 4.3/10(f) 04 = 4.3/10(m) 05 = 7/16 DIN(f) 06 = 7/16 DIN(m)	01 = N(f) 02 = N(m) 03 = 4.3/10(f) 04 = 4.3/10(m) 05 = 7/16 DIN(f) 06 = 7/16 DIN(m)	01 = N(f) 02 = N(m) 03 = 4.3/10(f) 04 = 4.3/10(m)
<b>Interface</b>	RJ-25	RJ-25	RJ-25	RJ-25	RJ-25
<b>Communication</b>	RS-458	Ethernet	RS-458	Ethernet	N/A
<b>Monitors</b>	Up to 16 Channels	Up to 16 Channels	N/A	N/A	N/A

\*Low power version





## Channel Power Monitor

### CPM SERIES

Comprised of a central processor and a variety of sensors, the Bird Channel Power Monitor System can be set up to monitor radio performance, combiner loss, and antenna/feedline characteristics providing continuous information on the health of each component it monitors.

This multiple-channel power monitoring system is capable of continuously monitoring power and VSWR performance simultaneously for up to 16 analog or digital channels and is scalable to accommodate any size radio system operating between 118 and 940 MHz. The CPM evaluates and monitors LMR systems by checking the key elements of the transmission path in real time and alerting users of degraded performance or failures.

### CPM SOLUTIONS

- Power monitor display and sensors allow you to build a system around your needs
- Monitor up to 16 non-directional and 16 directional sensors simultaneously
- Measures forward, reflected, composite and individual channel power as well as antenna system VSWR
- Monitoring of the system is accomplished via interface with the front panel or accessed through the built in web server and web page
- Configurable alarming for high and low level power and high antenna VSWR, utilizing hard contact and SNMP formats
- Standard Push-to-Talk (PTT) compatibility

### 3141 PRODUCT FEATURES

- The central display user interface via the front panel display and buttons or via an Internet connection and a network accessible web page (GUI interface)
- Designed for a 19 in rack and 1 RU
- Two digital sensor inputs, up to 16 digital sensors may be serially connected (daisy-chained)
- 16 analog inputs. RJ-25 Connectors are used to connect each analog channel to an analog sensor
- Three user-defined inputs which can be connected to sensors/contacts of the customer's choice

### MONITOR SELECTION GUIDE

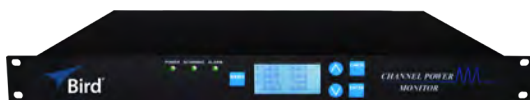

3141 SERIES	INPUT VOLTAGE	INPUT CURRENT	FUSE RATING
3141A15	+15 VDC (supplied by 115/230 VAC Adapter)	<3 Amps	5 Amp
3141A48	±48 VDC (+48 or -48)	<1 Amp	1.25 Amp



## Power Sensors

### 4042, 4043, & 4044 SERIES

Bird power sensors used with the CPM, support analog and digitally modulated radio. Our non-directional sensor model 4044 and directional sensor model 4043 are both available in seven models covering bands from 118 to 940 MHz. The 4042 channel sensor covers a frequency range of 100 to 1000 MHz. It is capable of measuring up to 16 single channels in the presence of multiple channels at the output of a frequency combiner. Analog and digital power sensors may be used together with a single CPM.

#### 4042 SERIES FEATURES

- Frequency Range 100 to 1000MHz
- Monitor antenna failure and radio power output simultaneously
- Single PTT power alarms allowing cycling through the frequencies
- Install post-combiner to monitor antenna VSWR

#### 4043 SERIES FEATURES

- Frequency range includes 7 bands between 118 and 940 MHz
- Provides composite power monitoring
- Alarm limits can be set by the user to provide alerts when crossed

#### 4044 SERIES FEATURES

- Measures output of either analog or digitally modulated radios up to 125 W
- Ideal for use at the input to each channel of the transmit combiner
- Frequency bands of 118 to 940 MHz

4042 SERIES Channel, Directional	FREQUENCY RANGE	MAX FORWARD POWER MEASUREMENT RANGE	MAX REFLECTED POWER MEASUREMENT	CONNECTOR OPTIONS	
4042-1-410505-yyzz	30 MHz to 200 MHz	10 W to 500 W	10 dB below Forward Power Range	<b>Input (yy) and Output (zz) Connectors</b> 01 = N(f) 03 = 4.3/10(f) 05 = 7/16 DIN(f) 02 = N(m) 04 = 4.3/10(m) 06 = 7/16 DIN(m)	
4042-1-430505-yyzz	100 MHz to 1000 MHz	25 W to 500 W			
4043 SERIES Composite, Directional	FREQUENCY RANGE	MAX FORWARD POWER MEASUREMENT RANGE	MAX REFLECTED POWER MEASUREMENT	ACCURACY	CONNECTOR OPTIONS
4043-1-420505-yyzz	118 MHz to 144 MHz	25 W to 500 W	10 dB below Forward Power Range	±5% of reading	<b>Input (yy) and Output (zz) Connectors</b> 01 = N(f) 02 = N(m) 03 = 4.3/10(f) 04 = 4.3/10(m) 05 = 7/16 DIN(f) 06 = 7/16 DIN(m)
4043-1-440505-yyzz	144 MHz to 244 MHz				
4043-1-450505-yyzz	380 MHz to 450 MHz				
4043-1-460505-yyzz	450 MHz to 512 MHz				
4043-1-470505-yyzz	762 MHz to 806 MHz				
4043-1-480505-yyzz	806 MHz to 869 MHz				
4043-1-490505-yyzz	896 MHz to 940 MHz				
4043-1-500505-yyzz	225 MHz to 400 MHz				
4044 SERIES Non-Directional	FREQUENCY RANGE	POWER RANGE	ACCURACY	CONNECTOR OPTIONS	
4044-1-420404-yyzz	118 MHz to 144 MHz	2.5 W to 125 W	±5% of reading	<b>Input (yy) and Output (zz) Connectors</b> 01 = N(f) 03 = 4.3/10(f) 02 = N(m) 04 = 4.3/10(m)	
4044-1-440404-yyzz	144 MHz to 244 MHz				
4044-1-450404-yyzz	380 MHz to 450 MHz				
4044-1-460404-yyzz	450 MHz to 512 MHz				
4044-1-470404-yyzz	762 MHz to 806 MHz				
4044-1-480404-yyzz	806 MHz to 869 MHz				
4044-1-490404-yyzz	896 MHz to 940 MHz				



## Ethernet Power Sensors

### 4042E & 4043E SERIES

A powerful approach to antenna and power monitoring for smaller radio communications systems and paging networks. With internal processing capabilities, it eliminates the need for additional monitoring and processing equipment. These Ethernet power sensors connect directly to the Internet or private IP network and can be accessed remotely for set-up and monitoring by displaying measurement information via a web browser on a Web UI.

### 4042E FEATURES

- Frequency Range 100 to 1000 MHz
- Monitor antenna failure and radio power output simultaneously
- Single PTT power alarms allowing cycling through the frequencies
- Install a post-combiner to monitor antenna VSWR

### 4043E FEATURES

- Frequency range includes 7 bands between 118 and 940 MHz
- Provides composite power monitoring
- Alarm limits can be set by the user to provide alerts when crossed

### APPLICATIONS

Commercial, industrial, and government land-mobile-radio (LMR) wireless-communications systems including:

- Public Safety
- Marine/Coast Guard
- Private Networks
- Railroad

4042E/4043E	FREQUENCY RANGE (ff)	FORWARD POWER (ww)	COMMUNICATION INTERFACE (xx)	CONNECTOR OPTIONS
4042E-1-ffwwxx-yyzz	41 = 30 to 200 MHz 43 = 100 to 1000 MHz	05 = 10 W to 500 W	03 = Ethernet	<b>Input (yy) and Output (zz) Connectors</b> 01 = N(f)    04 = 4.3/10(f) 02 = N(m)    05 = 7/16 DIN(f) 03 = 4.3/10(f) 06 = 7/16 DIN(m)
4043E-1-ffwwxx-yyzz	42 = 118 MHz to 144 MHz 44 = 144 MHz to 244 MHz 45 = 380 MHz to 450 MHz 46 = 450 MHz to 512 MHz 47 = 762 MHz to 806 MHz 48 = 806 MHz to 869 MHz 49 = 896 MHz to 940 MHz 50 = 225 MHz to 400 MHz*	02 = .25 W to 5 W 03 = 2.5 W to 50 W 05 = 25 W to 500 W	03 = Ethernet	<b>Input (yy) and Output (zz) Connectors</b> 01 = N(f)    04 = 4.3/10(f) 02 = N(m)    05 = 7/16 DIN(f) 03 = 4.3/10(f) 06 = 7/16 DIN(m)

### MEASUREMENT

<b>Impedance</b>	50 Ohms nominal
<b>Insertion Loss</b>	0.2 dB max
<b>Insertion VSWR</b>	1.15 max
<b>Directivity</b>	25 dB min
<b>Peak/Average Ratio</b>	12 dB max
<b>Accuracy</b>	±5% of reading

### CONNECTORS

<b>Interface</b>	Ethernet 10/100/1000BASE-T (auto-sensing) Version 2.0/IEEE 802.3
<b>RF Connectors</b>	Input: N(f), N(m), 4.3/10(f), 4.3/10(m), 7/16 DIN(f), 7/16 DIN(m) Output: N(f), N(m), 4.3/10(f), 4.3/10(m), 7/16 DIN(f), 7/16 DIN(m)

### SYSTEM

<b>Supported Protocols</b>	TCP/IP Hosted web page, SNMP v2.0 Client
<b>Power Supply</b>	5.5-25 VDC, 3W max, 0.08 in (2 mm) power jack. 15 VDC adapter included
<b>Operating Position</b>	Any
<b>Push-to-Talk input (PTT) for spurious alarm suppression</b>	NO or NC logic (software selectable), 3.5mm terminal push-lock, optically isolated

### ENVIRONMENTAL

<b>Humidity</b>	95% max, non-condensing
<b>Altitude</b>	15,000 ft (4,572 m) max
<b>Operating Temp.</b>	0 °C to 50 °C (32 °F to 122 °F)
<b>Storage Temp.</b>	-40 °C to 80 °C (-40 °F to 176 °F)

### PHYSICAL

<b>Size (without connectors)</b>	5.4 in x 3.8 in x 1.4 in (137 mm x 97 mm x 36 mm)
<b>Weight</b>	0.6 lb (.27 kg)

### CERTIFICATIONS

<b>Certifications</b>	CE, RoHS
-----------------------	----------



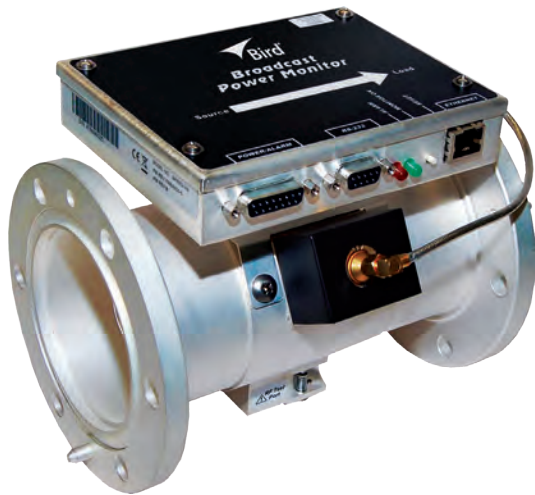

MADE IN USA

## PRODUCT FEATURES

- Integral RF test port enables mask compliance testing, as well as monitoring of spectrum, modulation, frequency & RF envelope performance
- Ethernet & RS-232 Enabled - Future-ready remote monitoring, control & instant alarm alert
- Data Logging Capabilities - System trends and anomalies can be detected before failures

## OPTIONAL DISPLAY

- 3129A rackmount remote power monitor panel

# Broadcast Power Monitor

## BPME SERIES

Bird's Broadcast power monitors are a compact, microprocessor-controlled instruments intended for long-term VSWR and power monitoring. Get continual, accurate power readings and VSWR monitoring with around-the-clock remote access from any web enabled device. This unit can be configured in the field for frequency and channel and offers integration of forward and reflected elements into the RF Detection/Control Circuit for added stability and greater dynamic range.

### MEASUREMENT

<b>Frequency Range*</b>	See chart
<b>Forward/Reflected Power Range*</b>	See chart
<b>Measurement Type</b>	In-line, True Average Power
<b>Peak/Average Ratio</b>	10 dB
<b>Coupler Directivity</b>	26 dB min, 30 dB typical
<b>Accuracy</b>	±5% of reading
<b>Dynamic Power Range</b>	20 dB

\* Frequency and power level depend on line section, sensor element, and selected display option. While designed for digital broadcast, the Broadcast Power Monitor can be used for a wide range of frequencies, power levels, and applications. Please contact the factory to discuss your application and requirements.

### SYSTEM

<b>Alarms</b>	VSWR, no/low forward power, high forward power
<b>Outputs</b>	SPDT relay contact
<b>Calibration Cycle</b>	Annual
<b>Display Options</b>	BPME PC Software or 3129A rackmount digital RF display

### INTERFACES

<b>Ethernet Port</b>	10Base-T or 100Base-TX (auto sensing)
<b>Protocols</b>	ARP, UDP/IP, TCP/IP, Telnet, ICMP, SNMP, DHCP, BOOTP, TFTP, Auto IP, and HTTP Security: 256-bit encryption; Serial RS-232, 9600 baud, no parity, 8 data bits, 1 stop bit, no handshake

### ENVIRONMENTAL

<b>Operating Temperature</b>	0 °C to 50 °C (32 °F to 122 °F)
<b>Storage Temperature</b>	-20 °C to 80 °C (-4 °F to 176 °F)
<b>Humidity</b>	95% ±5% max non-condensing
<b>Altitude</b>	up to 10,000 ft (3,048 m)

### CERTIFICATIONS

<b>CE</b>	EMC EN 61326-1:2006 and Safety EN 61010-1:2001
-----------	--

# Broadcast Power Monitor

## BPME SERIES

### MONITOR SELECTION GUIDE

LINE SIZE	POWER DESIGNATOR	VHF (45 MHz to 230 MHz)	UHF (470 MHz to 890 MHz)
		FORWARD POWER RANGE	FORWARD POWER RANGE
7/8 in	Low	5 W to 500 W	2.5 W to 250 W
	Medium	20 W to 2000 W	10 W to 1000 W
	High	50 W to 5000 W	25 W to 2500 W
1 5/8 in	Low	20 W to 2000 W	5 W to 500 W
	Medium	80 W to 8 kW	20 W to 2000 W
	High	200 W to 20 kW	50 W to 5000 W
3 1/8 in	Low	50 W to 5000 W	25 W to 2500 W
	Medium	200 W to 20 kW	100 W to 10 kW
	High	500 W to 50 kW	250 W to 25 kW
4 1/16 in & 4 1/2 in	Low	100 W to 10 kW	40 W to 4 kW
	Medium	400 W to 40 kW	150 W to 15 kW
	High	1000 W to 100 kW	400 W to 40 kW
6 1/8 in	Low	200 W to 20 kW	80 W to 8 kW
	Medium	800 W to 80 kW	300 W to 30 kW
	High	2000 W to 200 kW	750 W to 75 kW



## Optional RF Power Display

### MODEL 3129A

#### PRODUCT FEATURES

- A single line display divided into two fields
- Displays forward power, and either reflected power or the match measurement
- Displays match measurements as VSWR, Rho, Return Loss, or efficiency
- Supplies DC power to the BPME
- Displays the BPME alarm status
- Provides an electrical interface for the discrete outputs from the BPME
- Provides a serial interface to connect a PC to the BPME

#### ENVIRONMENTAL

<b>Operating Temperature</b>	-10 °C to 50 °C (-14 °F to 122 °F)
<b>Storage Temperature</b>	-40 °C to 80 °C (-40 °F to 176 °F)
<b>Humidity</b>	95% ±5% (non-condensing)
<b>Altitude</b>	Up to 10,000 ft (3,048 m)

#### PHYSICAL

<b>Size</b>	19 in x 1.75 in x 5" (1 RU) (483mm x 44 mm x 127 mm)
<b>Weight</b>	<10 lb

#### CERTIFICATIONS

<b>Compliance</b>	CE, RoHS
-------------------	----------

#### SYSTEM

<b>Supported Protocols</b>	RS-232, 9600 baud, no parity, 8 data bits, 1 stop bit, no handshake
<b>Power Supply</b>	115/230 VAC @ 50/60 Hz, 6A

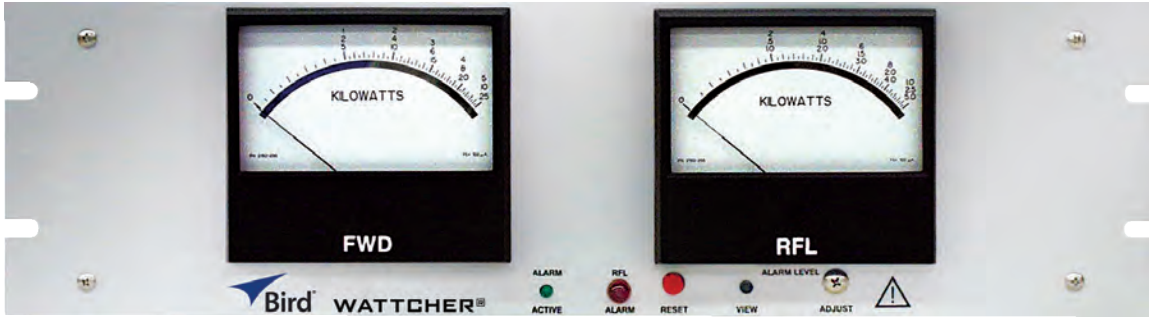

## Single Carrier RF Monitors/Alarms

### 3127A & 3128A SERIES

The 3127A and 3128A Wattcher® RF Power Monitors/Alarms are designed to protect and monitor your RF frequency transmission system by connecting the power meter to a Bird dual port ThruLine® line section and two elements compatible with the RF coaxial line.

The elements are selected by the user to cover the desired power levels and frequency ranges. Remote access is available for resetting audible and visual alarms. Fail-safe or non fail-safe modes are user selectable and the reflected power trip level is adjustable.

	3127A	3128A
<b>Frequency Range</b>	2 MHz to 1 GHz	450 kHz to 1 GHz
<b>Power Range</b>	100 W to 250 kW using Bird® Plug-in Elements	100 mW to 10 kW using Bird® Plug-in Elements
<b>Insertion VSWR</b>	N/A	with N connectors 1.05 max to 1000 MHz, 1.1 max to 2700 MHz
<b>Accuracy</b>	±5% of full scale	±5% of full scale
<b>Meter Scales FWD</b>	5, 10, 25 kW	25, 50, 100 W
<b>Meter Scales RFL</b>	1, 2.5, 5 kW	25, 50, 100 W
<b>Meter Sensitivity</b>	100 µA/3000 Ω	30 µA/1400 Ω
<b>Required Products</b>	Line Section: 1 5/8", 3 1/8", 4 1/16", 6 1/8"	Line Section: 4522-002-5 QC Connectors: Two
<b>Elements</b>	Two from Tables 1 5/8 A, 3 1/8 A, 4 1/16 A, or 6 1/8 A	Two from Tables 1, 2, 3, 4, or 6
<b>Accessories</b>	Cable: If length other than 25 ft is desired, order two BNC(m) cables	-

#### SYSTEM

<b>AC Power</b>	115/230 V, 50/60 Hz @ 0.125 A max
<b>DC Power</b>	9 to 16 V @ 1 A max
<b>Front Control Panel</b>	Reset push-button, reflected power limit display button, adjust alarm level recessed screw
<b>Back Control Panel</b>	FWD/RFL DC signal inputs (BNC), DC power/remote reset connector, DPDT interlock relay connector, fail-safe/nonfail-safe selector, alarm buzzer disable, AC line voltage selector, safety fuses and IEC 320 AC receptacle.
<b>Alarms</b>	Front panel buzzer and red LED
<b>Cable</b>	Includes two 25 ft DC cables

#### ENVIRONMENTAL

<b>Operating Temperature</b>	-10 °C to 50 °C (-14 °F to 122 °F)
<b>Storage Temperature</b>	-40 °C to 80 °C (-40 °F to 176 °F)
<b>Humidity</b>	95% ±5% (non-condensing)
<b>Altitude</b>	Up to 10,000 ft (3,048 m)

#### PHYSICAL

<b>Size</b>	5.22 in x 19 in x 3.75 in (133 mm x 483 mm x 95 mm)
<b>Weight</b>	5 lb (2.28 kg)
<b>Finish</b>	Gray powder coat



## Dual Element, Single Carrier RF Monitor/Alarm

### MODEL 3170B

The dual meter/dual element 3170B Wattcher® RF Monitor and Alarm System can protect your transmitting equipment from damage and loss of air time when faults cause high-standing waves. It can warn a remote operator of low power due to detuning, component deterioration, or AC line difficulties and high reflected power due to factors such as antenna icing, transmission line problems, physical accidents and lightning strikes.

This power monitoring capability is accomplished through the use of a dual-port 50 Ohm insertion-type line section. Each port must contain a standard Bird plug-in element.

3170B	
<b>Power Range</b>	100 mW to 10 kW using Bird® Plug-in Elements
<b>Frequency Range</b>	450 kHz to 1 GHz
<b>Insertion VSWR</b>	with N connectors 1.05 max to 1000 MHz
<b>Accuracy</b>	±5% of full scale
<b>Meter Scales FWD/RFL</b>	FWD and RFL 25, 50, 100 W
<b>Meter Sensitivity</b>	100 µA/3000 Ω
<b>Elements</b>	Two from Tables 1, 2, 3, 3A, 4, or 6

#### SYSTEM

<b>AC Power</b>	115/230 VAC, 50/60 Hz @ 56 mA
<b>DC Power</b>	12.7 to 16.0 VDC @ 400 mA max
<b>Front Control Panel</b>	Reset push-button, adjust FWD/RFL alarm levels screw, element sockets
<b>Back Control Panel</b>	DC FWD/RFL signal inputs, main and remote meter drive outputs, external 12 to 16 VDC supply input, alarm in/out, reset in/out, AC line voltage selector, fuse, IEC 320 AC receptacle.
<b>Alarms</b>	Front Panel Buzzer, "Active" and "Trip" LEDs for forward/reflected
<b>Response Time</b>	25 µs max
<b>Activate Forward</b>	73 µs to 50 ms nominal (adjustable) monitor delay
<b>Calibration Cycle</b>	1 year for element

#### CONNECTORS

<b>Inputs/Outputs</b>	TTL compatible +5 V logic Outputs for remote meter
<b>Connectors</b>	QC Type (Female N normally supplied)

#### PHYSICAL

<b>Size</b>	19 in x 5.25 in x 9.3 in (483 mm x 133 mm x 237 mm)
<b>Weight</b>	7 lb (3.2 kg)
<b>Finish</b>	Gray powder coat





# RF POWER METERS

## Reliability for Test and Measurement in the Field or on the Bench

Bird® designs and builds reliable and superior RF wattmeters and RF line sections whether for harsh conditions or the most challenging situations. Reliability is both a promise and our reality. Bird makes the world's most reliable wattmeters and RF line sections because we have to. No matter the product or its application or its customer, each is made with our single-minded devotion to reliability.



PORTABLE WATTMETERS

Page 60 - 65



PANEL MOUNT WATTMETERS

Page 66 - 67



RIGID LINE SECTIONS

Page 68



FIELD REPLACEMENT METER

Page 69



PLUG-IN ELEMENTS

Page 70 - 75

**MADE IN  
USA** 



# RF Power Meters

Bird® offers a wide selection of portable insertion-type instruments for measuring forward and reflected power in coaxial transmission lines. ThruLine® instruments can be left in the line for continuous monitoring of the transmitter power output or the amount of RF power reflected by an antenna.



## 1 TYPES OF POWER METERS

- **Terminating Power Meters** – measures the RF energy that is terminated in a load using either a thermistor, thermocouple, or diode detector. To measure RF power and not damage the RF sensor, a terminating sensor must use an attenuator or directional coupler. This method will introduce mismatch errors which contribute to the overall measurement accuracy.
- **In-line Power Meters** – measures forward and reflected RF energy in a transmission line without disrupting service. Unlike a terminating power meter, the in-line meter is non-intrusive and there is no need for additional equipment to make the measurement. In addition to measuring transmitter power, they can be used to install and maintain wireless base stations, RF generators or repeaters.

## 2 WHAT ARE ELEMENTS?

Bird wattmeters and other thru-line instruments are based on a “lumped constant” directional coupler. The directional coupler is called an element. Many users also call it a “slug” or a “plug-in”.

Each plug-in element (or coupler) samples the voltage at the point of insertion and samples the current via a loop. Turning the element 180° reverses the loop (and consequently the current pick-up) while the voltage sample remains unchanged. By proper combination of the two parameters, we obtain an RF voltage proportional to the square root of main line RF power. The RF sample is then rectified and a DC signal proportional to the RF envelope is delivered to the meter.

Unlike terminating sensors, Bird elements are carefully designed, manufactured, and calibrated to ensure proper directional RF measurements, without the need for calibration charts or instrument adjustments.

## 3 BEST PRACTICES

To make an accurate RF power measurement, you need to choose the right wattmeter or sensor and follow these best practices:

**Type of Signals** – the type of signals to be measured greatly influence the reading. Are you measuring a CW signal or one that has analog or digital modulation? How about a pulsed signal? Make sure the wattmeter or sensor is designed to measure your desired signal.

**Eliminate adapters** - Best practice for making a RF power measurement is to eliminate or minimize connector adapters. Your power meter may have great directivity, but the reading will be degraded when using many adapters. Use the proper connector to minimize mismatch errors that will impact your RF power reading.

**Connectors & Cables** – many errors when making an RF power measurement are due to worn connectors or damaged cables. RF measurements depend on the integrity of your cables and connectors used to interconnect the various instruments and devices. Inspect for damage and dirt before connections are made. Metal shavings, bent/cracked center pins can cause poor repeatability and high/variable VSWR.

**Directivity** – a directional coupler is a key component of every in-line, directional power meter element or “slug”. The directivity parameter, expressed in decibels (dB), is a measure of how well the coupler is capable of distinguishing between the energy traveling towards the load, and the energy that is being reflected due to the load impedance mismatch.



## Portable Thru-line Wattmeters

### MODEL 43 SERIES, 44 SERIES, & APM-16

The Model 43 Series, Model 44 Series, and APM-16 of Thru-line Directional Wattmeters provide accurate forward and reflected power in 50 Ohm coaxial transmission lines providing instant readings or continuous monitoring. Bird's Plug-in elements determine the power rating and the frequency range so there is no need for calibration charts or instrumentation adjustments. Bird offers a broad selection of portable wattmeters ranging from broadband, fixed, peak, and variable signal measurements.

### PRODUCT FEATURES

- Insertion-type instrument designed to measure both forward and reflected CW power in coaxial transmission lines under any load condition.
- Full-scale accuracy of  $\pm 5\%$
- QC (quick change) type connectors
- Full range of plug-in elements provide a wide choice of frequency ranges and power levels

### BENEFITS

- Measures power as it is being delivered to the load; allows the power meter to be kept in the circuit as the load is active
- Rugged metal housing for the most demanding environments
- Remote installation with removable RF line section
- High directivity and accuracy measurements needed for exceptional system performance



# Portable Thruline Wattmeters

## MODEL 43 SERIES, 44 SERIES, & APM-16

### 43 SERIES WATTMETER SELECTION GUIDE

	43	43P	4314C	4304A	4391A
<b>Type</b>	Broadband Wattmeter	Broadband Wattmeter with Peak Power	Broadband Wattmeter with Peak Envelope & Pulsed Power	Single Element Wattmeter	Dual-element Wattmeter
<b>Modulation</b>	CW, AM, FM, and analog TV	CW, AM, FM, SSB and analog TV	CW, AM, FM, SSB, analog TV, and pulsed signals	CW, AM, FM, and analog TV	CW, Pulsed RF (air navigation, DME, ATC, telemetry, radar etc.)
<b>Measurement</b>	Average RF power	Peak pulsed power, average RF power	Peak envelope, peak pulsed, average RF power	Average RF power	Peak envelope, peak pulsed, average RF power
<b>RF Power Range</b>	100 mW to 10 kW (depending on element)	100 mW to 10 kW (depending on element)	100 mW to 10 kW (depending on element)	5 W, 15 W, 50 W, 150 W, 500 W	100 mW to 10 kW (depending on element)
<b>Frequency Range</b>	450 kHz to 1.2 GHz (depending on element)	450 kHz to 1.2 GHz (depending on element)	450 kHz to 1.2 GHz (depending on element)	25 MHz to 1.0 GHz	450 kHz to 1.5 GHz (depending on element)
<b>Power Accuracy</b>	±5% of full scale	<b>CW Mode:</b> ±5% of full scale <b>Peak Mode:</b> ±8% of full scale	<b>CW Mode:</b> ±5% of full scale <b>PEP Mode:</b> ±8% of full scale	±6 to 7% full scale	<b>CW Mode:</b> ±5% of full scale <b>PEP Mode:</b> ±8% of full scale
<b>Pulse Parameters</b>	NA	<b>Pulse width:</b> 200 us min <b>Duty cycle:</b> 2% min <b>Pulse repetition:</b> 100 pps min	<b>Pulse width:</b> 0.4 us min (100 to 2300 MHz), 1.5 us (26 to 99 MHz), 15 us (2 to 25 MHz) <b>Duty cycle:</b> 0.01% min <b>Pulse repetition:</b> 30 pps min	NA	<b>Pulse width:</b> 0.8 us min (100 to 1260 MHz), 1.5 us (26 to 99 MHz), 15 us (2 to 25 MHz) <b>Duty cycle:</b> 0.01% min <b>Pulse repetition:</b> 25 pps min
<b>Connectors</b>	Two Type-N(f) QC	Two Type-N(f) QC	Two Type-N(f) QC	Two Type-N(f) QC Two UHF(f) QC	Two Type-N(f) QC
<b>Elements*</b>	Tables 1, 2, 3, 4, 6, 13, 14	Tables 1, 2, 3, 4, 5, 6	Tables 1, 2, 3, 4, 5, 6, 13, 14	One 4240-050 & one 4304A-1 elements supplied with unit	Tables 1, 2, 3, 4, 5, 6, 13, 14
<b>Power</b>	None required	Two 9 V alkaline	Two 9 V alkaline	None required	AC power cord or six rechargeable C cell batteries

\*All Bird® Wattmeters require Bird's Plug-in Elements.

### 44 SERIES/APM-16 WATTMETER SELECTION GUIDE

	4431	4410A	APM-16
<b>Type</b>	Broadband Wattmeter with Variable RF Sample Port	Wattmeter with Multi-power Level Elements	Wattmeter for Digital Mobile Radio
<b>Modulation</b>	CW, AM, FM, and analog TV	CW or FM signals	CDMA, TDMA, FDMA & other digitally modulated signals
<b>Measurement</b>	Average RF power	Average RF power	Average RF power
<b>RF Power Range</b>	5 kW max (2 to 30 MHz) 1 kW max (30 to 1000 MHz)	100 W, 1000 W or 10,000 W in single plug-in element	1 to 1000 W
<b>Frequency Range</b>	2 MHz to 1.2 GHz	200 kHz to 1.0 GHz	2 MHz to 960 MHz
<b>Power Accuracy</b>	±5% of full scale	±5% of reading	±4% of reading, ±1% of full scale
<b>Pulse Parameters</b>	NA	NA	NA
<b>Connectors</b>	Two Type-N(f) QC	Two Type-N(f) QC	Two Type-N(f) QC
<b>Elements*</b>	Tables 1, 2, 3, 4, 6, 13, 14	4410 elements	APM elements
<b>Power</b>	None required	One 9 V alkaline	One 9 V alkaline

\*All Bird® Wattmeters require Bird's Plug-in Elements.





**PRODUCT FEATURES**

- Temperature-compensated accurate CW and FM power measurements from 200 kHz to 1.0 GHz and 300 mW to 10 kW
- Uses special 4410-series wide-range elements
- Wide-range accuracy over a 37 dB dynamic range and superior temperature performance
- Quick Change (QC) connectors to minimize the need for adapters when making critical measurements

# Multipower RF Wattmeters

## 4410A

The 4410A RF Wattmeter has the basic principles of the Model 43 but transforms it into a highly accurate high dynamic range instrument. The mirrored-scale linear range meter has 2 switchable ranges, 0 to 1 and 0 to 3.

Power is read as a multiple of the value indicated by the pointer, the decimal point location depending upon the range switch position and the factor printed on the plug-in element. Power ranges covered by individual elements are 300 mW to 1 KW and 2 W to 10 KW, full scale. For most elements, accuracy is +/-5% anywhere above 20% of full scale.

**ELEMENT SELECTION GUIDE**

POWER RANGE	FREQUENCY BANDS (MHz)										
	0.2 to 0.535	0.45 to 2.5	2 to 30	25 to 80	50 to 125	50 to 200	100 to 250	144 to 520	200 to 500	200 to 1000	400 to 1000
<b>0 to 10 W, 30 W, 100 W, 300 W, 1000 W, 3000 W, 10,000 W</b>	4410-1	4410-2	4410-4	—	—	—	—	—	—	—	—
<b>0 to 1 W, 3 W, 10 W, 30 W, 100 W, 1000 W</b>	—	—	4410-3	4410-5	—	4410-6	—	4410-7	—	4410-8	—
<b>0 to 100 mW, 300 mW, 1 W, 3 W, 10 W, 30 W, 100 W</b>	—	—	—	4410-10	4410-11	—	4410-12	—	4410-13	—	4410-14

**MEASUREMENT**

<b>Power Range</b>	300 mW to 1 kW or 2 W to 10 kW full scale in one single Plug-in Element
<b>Frequency Range</b>	200 kHz to 1.0 GHz CW or FM
<b>Insertion VSWR</b>	With N connectors 1.25 max to 2300 MHz
<b>Accuracy</b>	±5% of reading for any reading above 20% of the Power Range selected for FM or CW signals without AM. This accuracy is maintained for a full 37 dB dynamic range with each 4410 Element (except No. 4410-1 200 kHz to 535 kHz which is accurate to ±10% of reading)
<b>Usable Over Range</b>	To 120% of nominal full scale

**CONNECTORS**

**RF Connectors** QC Type (Female N normally supplied)

**SYSTEM**

**Battery Type**  
**4410A** 9V Alkaline, included  
**4412A** Rechargeable (see website)  
 (i.e. 12 W, 120 W, 1200 W, or 12,000 W). No damage or degradation to the unit will result, regardless of the Range Selector Switch position.

**Protection**

**ENVIRONMENTAL**

**Ambient Temperature** Elements 4410-1 through -8 and -10 through -14 are temperature compensated for rated accuracy from 0 °C to 50 °C (32 °F to 122 °F)

**PHYSICAL**

**Size** 6.88 in x 5.13 in x 3.63 in (with connectors)  
**Weight** 3 lb (1.4 kg)  
**Finish** Gray powder coat

**OPTIONAL ACCESSORIES**

<b>4300A055</b>	Wattmeter, Load, 4 Elements & Accessories Carrying Case
<b>EC-1</b>	12 Plug-In Elements Carrying Case
<b>5-1375</b>	9V, Alkaline Battery

**COMPATIBLE ELEMENTS**

**4410 Elements** See selection guide above



## PRODUCT FEATURES

- Designed especially for RF power measurement in PCS, cellular, ESMR, paging and similar communication systems
- Equally effective for measuring RF power in conventional analog systems
- Uses APM-series plug-in elements to cover a wide range of frequency and power levels. Simple ThruLine® style operation for instant forward or reflected power readings
- Interchangeable QC connectors for fast hook-up

# Average Reading RF Power Meter

## APM-16

The APM-16 RF Wattmeter is designed to keep pace with the ever growing complexity of digitally-based communication systems. The APM-16 employs active circuitry to deliver accuracy of  $\pm 5\%$  for multiple-access technologies such as CDMA, TDMA, FDMA and other digitally-encoded communication systems.

## ELEMENT SELECTION GUIDE

POWER RANGE	FREQUENCY BANDS (MHz)						
	2 to 30	25 to 60	50 to 125	100 to 250	200 to 500	400 to 800	800 to 960
1 W	—	—	APM-1B	APM-1C	—	APM-1E-400	APM-1E-800
2.5 W	—	—	APM-2.5B	—	APM-2.5D	APM-2.5E-400	APM-2.5E-800
5 W	APM-5H	APM-5A	APM-5B	APM-5C	APM-5D	APM-5E-400	APM-5E-800
10 W	—	APM-10A	APM-10B	APM-10C	APM-10D	APM-10E-400	APM-10E-800
25 W	—	—	APM-25B	APM-25C	APM-25D	APM-25E-400	APM-25E-800
50 W	—	—	—	APM-50C	APM-50D	APM-50E-400	APM-50E-800
100 W	APM-100H	APM-100A	APM-100B	APM-100C	APM-100D	APM-100E-400	APM-100E-800
250 W	APM-250H	APM-250A	APM-250B	APM-250C	APM-250D	APM-250E-400	APM-250E-800
500 W	—	—	APM-500B	APM-500C	APM-500D	APM-500E-400	APM-500E-800
1000 W	APM-1000H	—	APM-1000B	APM-1000C	—	—	—

### MEASUREMENT

Power Range	1 W to 1000 W
Frequency Range	2 MHz to 960 MHz
Insertion VSWR	with N Connector 1.05 max to 1000 MHz
Accuracy	10 °C to 35 °C $\pm 4\%$ reading, $\pm 1\%$ full scale -20 °C to 50 °C $\pm 6\%$ reading, $\pm 2\%$ full scale
Peak to Average Ratio	In excess of 10 dB
Setting Time	< 1 second
Meter Scales	Shock mounted, linear scale with expanded scales of 25, 50 and 100 for full scale 1 to 1000 W readings. Mirrored scale includes 5% overrange.

### CONNECTORS

RF Connectors	QC Type (Female N normally supplied)
---------------	--------------------------------------

### SYSTEM

Battery Type	Internal 9 V, included
--------------	------------------------

### ENVIRONMENTAL

Operating Temperature	-20 °C to 50 °C (-4 °F to 122 °F)
Storage Temperature	-25 °C to 65 °C (-13 °F to 149 °F)
Humidity	95% $\pm 5\%$ max (non-condensing)

### PHYSICAL

Size	6.88 in x 5.13 in x 3.63 in (175 mm x 130 mm x 92 mm)
Weight	3 lb (1.4 kg)
Finish	Black powder coat

### OPTIONAL ACCESSORIES

4300-061	Wattmeter, Load, Signal Sampler, QC Connectors & 4 Elements Carrying Case
CC-6	Wattmeter, 5 Elements and 1 Small Load Carrying Case
EC-1	12 Plug-In Elements Carrying Case

### COMPATIBLE ELEMENTS

APM Elements See selection guide above



## PRODUCT FEATURES

- Frequency: .45 MHz or 45 mW to 1.5 GHz
- Power: 100 mW to 10 kW
- Measures peak or average power flow, load match, and amplitude modulation in 50 Ohm coaxial transmission lines.
- Reads forward and reflected CW or FM power in watts or dBm
- Use with CW, AM, FM, SSB, TV, and Pulse modulation envelopes.
- Calculates SWR, return loss in dB and 5 modulation
- Shock-resistant keyboard and range switches

## PEP-Dual Element, RF Power Analyst

### 4391A

The 4391A is a multi-purpose RF Wattmeter designed around a microcomputer. It will compute VSWR, amplitude modulations, and various decibel variables reducing the odds of error. A program stored in permanent memory controls the operation of the instrument at all times allowing for consistent or repeatable measurements no matter who makes the reading.

Monitors Peak Pulse Power, Peak Envelope Power, or CW Power during normal equipment operations in the forward or reflected direction. Designed for air navigational aids DME, ATC and other pulsed RF systems such as telemetry, radar, command and control, etc.

It needs no attenuators, directional couplers or charts and power range and frequency band are determined by the Plug-in Elements used.

### MEASUREMENT

<b>Power Range</b>	100 mW to 10 kW using Bird® Plug-in Elements*
<b>Frequency Range</b>	Built in, 450 kHz to 1.5 GHz
<b>Insertion VSWR</b>	with N connectors 1.05 max to 1000 MHz
<b>Accuracy</b>	<b>Power Readings:</b> CW: ±5% of full scale PEP: ±8% of full scale VSWR: ±10% of reading <b>% Modulation:</b> (CW power 1/3 or more of full scale), ±5% (0-90%), ±10% (90-100%)
<b>Usable Over Range</b>	to 120% of scale (CW, PEP, SWR and Return Loss)
<b>Sampling Rate</b>	2 to 3 readings per second
<b>Modulation</b>	25 to 10,000 Hz (Audio)
<b>Pulse Parameters</b>	<b>Pulse Width:</b> 0.8 μs (100 to 1260 MHz), 1.5 μs (26 to 99 MHz) and 15 μs (2 to 25 MHz); <b>Repetition Rate:</b> 25 PPS; <b>Duty Factor:</b> 1 x 10 <sup>-4</sup>
<b>Return Loss</b>	±0.3 dB to corresponding SWR value

\*Quoted accuracy only when used with other Bird® products.

### CONNECTORS

<b>RF Connectors</b>	QC Type (Female N normally supplied)
----------------------	--------------------------------------

### SYSTEM

<b>Display</b>	3.5 digit, 0.3 in LED strobed
<b>Battery Type</b>	1.2V, NiMH Rechargeable
<b>Battery Operating Time</b>	8 hours
<b>AC Power Supply</b>	100-130/200-260 V, 50/60 Hz, 6 W

### ENVIRONMENTAL

<b>Operating Temperature</b>	10 °C to 45 °C (50 °F to 113 °F)
<b>Storage Temperature</b>	-20 °C to 45 °C (-4 °F to 113 °F)

### PHYSICAL

<b>Size</b> (with connectors)	9.56 in x 5.22 in x 4.31 in (243 mm x 158 mm x 110 mm)
<b>Weight</b>	5.75 lb (2.6 kg)
<b>Finish</b>	Blue vinyl with silver anodized side panels

### OPTIONAL ACCESSORIES

<b>4300A085</b>	Carrying Case
<b>5A1230</b>	1.2V, NiMH Rechargeable Battery

### COMPATIBLE ELEMENTS

<b>4391A Elements</b>	Select two elements in a 10:1 power ratio from Tables 1, 2, 3, 4, 5, 6 and 14
-----------------------	---



## PRODUCT FEATURES

- Rigid Line Wattmeters are offered with a choice of meter scales
- Available with or without a forward/reflected power switch

## Rigid Line Wattmeters

### 6810 SERIES

The 6810 Series of 100 $\mu$ A Rigid Line RF Wattmeters forms a complete power measurement system when combined with the appropriate rigid line section and plug-in elements.

Elements must be ordered according to the desired frequency and power ranges, the meter scales and size of the line section selected for use with the meter.

6810 SERIES	TYPE	SCALES	DC CABLE	USES LINE SECTION
6810-220	4.5 in rectangular meter in housing with FWD and RFL switch	5/10/25 kW	Supplied Cable, 10 ft	Double socket
6810-230	4.5 in rectangular meter in housing with FWD and RFL switch	15/30/60 kW	Supplied Cable, 10 ft	Double socket
6810-309-7	4.5 in rectangular meter in housing	5/10/25 kW	Supplied Cable, 10 ft	Single socket

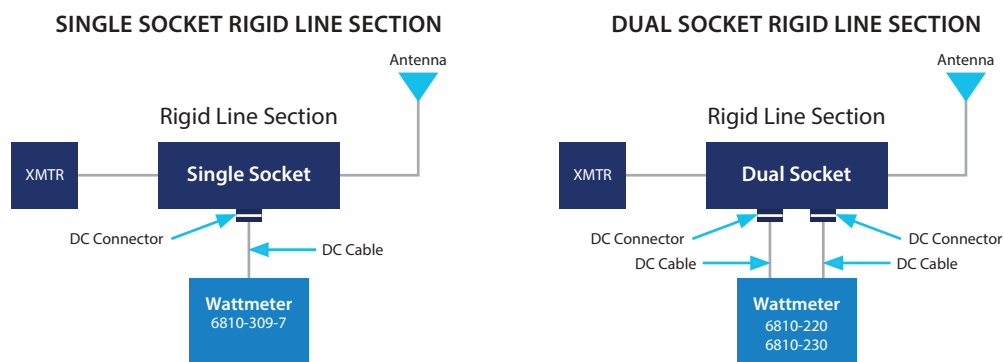





## Rigid Line Wattmeters

### 3127 SERIES

The 3127 Series of 100µA Rigid Line RF Wattmeters forms a complete power measurement system when combined with the appropriate rigid line section and plug-in elements.

Elements must be ordered according to the desired frequency and power ranges, the meter scales and size of the line section selected for use with the meter.

3127 SERIES	TYPE	SCALES	DC CABLE	USES LINE SECTION
3127-040	Dual 4.5 in rectangular meter on panel	5/10/25 kW	4220-097-10- RF Coaxial Cable. 25 ft	Double socket
3127-075	Dual 4.5 in rectangular meter on panel	15/30/60 kW	4220-097-10- RF Coaxial Cable. 25 ft	Double socket

#### PHYSICAL

<b>Size</b> (with connectors)	19 in x 5.22 in x 4.38 in (483 mm x 132.6 mm x 111.25mm)
<b>Weight</b>	4 lb (1.8 kg)
<b>Finish</b>	Gray



## Dual Meter, Dual Element, Panel-Mount RF Wattmeters

### MODELS 4526 & 4527

The Model 4526 & 4527 panel-mount RF Wattmeters have both dual-meter and dual-element sockets. These features let you determine VSWR more precisely using a more sensitive reflected power element and simultaneously read forward and reflected power. The panel mount styles are versions of our legacy tested Model 43 and are used in rack installation. The 4527 has an RF sampler that provides a low power sample of the main RF signal. The sampler output may be fed to any RF signal suitable monitoring device, e.g., a frequency counter, spectrum analyzer, or oscilloscope. Consult with the factory for appropriate combined transmitter monitoring products.

	4526	4527
<b>Frequency Range</b>	450 kHz to 1.2 GHz (depending on element)	2 to 512 MHz (depending on element)
<b>Insertion VSWR</b>	With N Connectors 1.05 max to 1000 MHz	With N Connectors 1.05 max to 512 MHz
<b>RF Sample Output</b>	N/A	Fixed at -53 dB from 512 to 10 MHz decreasing to -70 dB at 2 MHz BNC(f) port
<b>Elements</b>	Tables 1, 2, 3, 4, 6	2 to 512 MHz models within Tables 1, 2, 6

\*Quoted accuracy only when used with other Bird® Products.

#### MEASUREMENT

<b>Power Range</b>	100 mW to 10 kW using Bird Plug-in Elements (applies only when coupling is less than 30 dB)
<b>Accuracy</b>	±5% of full scale

\*Quoted accuracy only when used with other Bird® Products.

#### CONNECTORS

<b>RF Connectors</b>	QC Type (Female N normally supplied)
----------------------	--------------------------------------

#### PHYSICAL

<b>Size</b>	5.22 in x 1.9 in x 1.69 in (with connectors) (133 mm x 48.3 mm x 43 mm)
<b>Weight</b>	3.5 lb (1.6 kg)
<b>Finish</b>	Gray powder coat



## Rigid Line Sections

### THRULINE® WATTMETER COMPONENTS

Bird manufactures 50 Ohm 7/8 in, 1-5/8 in, 3-1/8 in, 4-1/16, and 6-1/8 in RF Line Sections. Each line section is equipped with one or two sockets where Plug-In Elements, in the desired power and frequency range, are inserted. Double-socket line sections are for simultaneous measurement of forward and reflected power. Designed for insertion between a RF transmitter and antenna or load.

#### LINE SECTION SELECTION GUIDE

7/8 inch	RF CONNECTOR	ELEMENT SOCKETS	LINE SIZE	LENGTH	WEIGHT
4230-006-1	QC (not included)	1	7/8 in	4 in	1 lb
4230-018	N-Type(f)	1	7/8 in	5.5 in	1.33 lb
4230-057	N-Type(f)	1 w/ Bracket	7/8 in	5.13 in	1.34 lb
4230-059	QC (not included)	1 w/ Bracket	7/8 in	4 in	1.25 lb
4522A002-5	QC (not included)	2 - Panel Mount	7/8 in	6.22 in	1.25 lb
1-5/8 inch	CONNECTOR TYPE	ELEMENT SOCKETS	LINE SIZE	LENGTH	WEIGHT
4715-000	EIA Flanged	2	1-5/8 in	6.75 in	3.25 lb
4723-000	Unflanged (Rec. 0.438 in)	2	1-5/8 in	6.38 in	1.5 lb
4723-020	Unflanged (Flush)	2	1-5/8 in	6.38 in	1.5 lb
3-1/8 inch	CONNECTOR TYPE	ELEMENT SOCKETS	LINE SIZE	LENGTH	WEIGHT
4610-000	EIA Flanged	2	3-1/8 in	7.03 in	7.25 lb
4801-100	Unflanged (Rec. 0.688 in)	2	3-1/8 in	6.5 in	4.25 lb
4802-000	Unflanged (Flush)	2	3-1/8 in	6.5 in	4.25 lb
4-1/16 inch	CONNECTOR TYPE	ELEMENT SOCKETS	LINE SIZE	LENGTH	WEIGHT
4642-010	Flanged (MYAT)	2	4-1/16 in	8.13 in	8.88 lb
6-1/8 inch	CONNECTOR TYPE	ELEMENT SOCKETS	LINE SIZE	LENGTH	WEIGHT
4905-000	EIA Flanged	2	6-1/8 in	10.22 in	17 lb

## Field Replacement Meter Movement Assembly Kit

### RPK43-4

The RPK43-4 is a complete replacement assembly kit for use with the Bird Model 43 Series of RF Wattmeters. This kit includes a 3.5 in round meter face, coaxial meter cable, shock ring, neoprene gasket -and shorting plug.

	RPK43-4
<b>Description</b>	3.5 in round replacement meter movement assembly kit
<b>Current</b>	30 $\mu$ A/1400 Ohms
<b>Meter Scales</b>	25/50/100 W
<b>Elements</b>	Tables 1, 2, 3, 4, 6
<b>Compatible with</b>	Bird Wattmeter models: 43, 43P, 4431, 4521, 4522, 4526 and 4527

## RF Wattmeter Movement Kit

### 4210A100

For custom applications and builds, the 4210A100 is a complete kit with a square meter pre-mounted in an aluminum housing. When combined with the appropriate 7/8 inch line section, QC connectors and elements you can assemble to a custom rack mount or use as a benchtop wattmeter.

	4210A100
<b>Description</b>	3.25 in square Wattmeter movement kit in aluminum housing
<b>Current</b>	30 $\mu$ A/1400 Ohms
<b>Meter Scales</b>	25/50/100 W
<b>Elements</b>	Tables 1, 2, 3, 4, 6

## Replacement Meter Movement Face

### RPK2080-002

The RPK2080-002 is a replacement meter face for use with the Bird Model 43 Series of RF Wattmeters.

	RPK2080-002
<b>Description</b>	3.5 in round replacement meter face movement assembly
<b>Current</b>	30 $\mu$ A/1400 Ohms
<b>Meter Scales</b>	25/50/100 W
<b>Elements</b>	Tables 1, 2, 3, 4, 6
<b>Compatible with</b>	Bird Wattmeter models: 43, 43P, 4431, 4521, 4522, 4526 and 4527



MADE IN  
USA



MADE IN  
USA



MADE IN  
USA





**ELEMENT SELECTION GUIDE**

MODEL	TABLE(S)	MODEL	TABLE(S)
3128A	1, 2, 3, 4, 6, 13, 14	4391A	1, 2, 3, 4, 5, 6, 13, 14
3170B	1, 2, 3, 4, 6, 13, 14	4410A, 4412A	13
43	1, 2, 3, 4, 6, 13, 14	4431	1, 2, 3, 4, 6, 13, 14
43P	1, 2, 3, 4, 5, 6, 13	4526	1, 2, 3, 4, 6, 13, 14
4314C	1, 2, 3, 4, 5, 6, 13, 14	4527	2 MHz to 512 MHz elements in 1, 2, 6, 13, 14

## Plug-In Elements

### FOR 7/8 IN LINE SECTIONS & WATTMETERS

All Bird Plug-In Elements are calibrated in accordance with meticulous Bird calibration procedures supported by a long history of mean deviation values to assure adherence to advertised specifications of current instruments, as well as field interchangeability with equipment purchased, used and trusted in all the years since its introduction.

**TABLE 1 STANDARD ELEMENTS**

POWER RANGE	FREQUENCY BANDS (MHz)						
	2 to 30	25 to 60	50 to 125	100 to 250	200 to 500	400 to 800	800 to 1000
5 W	—	5A	5B	5C	5D	5E-400	5E-800
10 W	—	10A	10B	10C	10D	10E-400	10E-800
25 W	25H	25A	25B	25C	25D	25E-400	25E-800
50 W	50H	50A	50B	50C	50D	50E-400	50E-800
100 W	100H	100A	100B	100C	100D	100E-400	100E-800
250 W	250H	250A	250B	250C	250D	250E-400	250E-800
500 W	500H	500A	500B	500C	500D	500E-400	500E-800
1000 W	1000H	1000A	1000B	1000C	1000D	1000E-400	1000E-800
2500 W	2500H	2500A	2500B	2500C	2500D	2500E-400	2500E-800
5000 W	5000H	5000A	5000B	5000C	5000D	5000E-400	5000E-800

**TABLE 2 LOW-POWER ELEMENTS**

POWER RANGE	FREQUENCY BANDS (MHz)										
	40 to 50	50 to 60	60 to 80	80 to 90	95 to 125	110 to 160	150 to 250	200 to 300	275 to 450	425 to 850	800 to 1000
1 W	040-1	050-1	060-1	080-1	095-1	110-1	150-1	200-1	275-1	425-1	801-1

POWER RANGE	FREQUENCY BANDS (MHz)											
	25 to 30	30 to 40	40 to 50	50 to 60	60 to 80	80 to 95	95 to 150	150 to 250	200 to 300	250 to 450	400 to 850	800 to 1000
2.5 W	025-2	030-2	040-2	050-2	060-2	080-2	095-2	150-2	200-2	250-2	400-2	801-2



## ELEMENT SELECTION GUIDE

MODEL	TABLE(S)	MODEL	TABLE(S)
3128A	1, 2, 3, 4, 6, 13, 14	4391A	1, 2, 3, 4, 5, 6, 13, 14
3170B	1, 2, 3, 4, 6, 13, 14	4410A, 4412A	13
43	1, 2, 3, 4, 6, 13, 14	4431	1, 2, 3, 4, 6, 13, 14
43P	1, 2, 3, 4, 5, 6, 13	4526	1, 2, 3, 4, 6, 13, 14
4314C	1, 2, 3, 4, 5, 6, 13, 14	4527	2 MHz to 512 MHz elements in 1, 2, 6, 13, 14

## Plug-In Elements

### FOR 7/8 IN LINE SECTIONS & WATTMETERS

**TABLE 3 HIGH-FREQUENCY ELEMENTS, ACCURACY  $\pm 8\%$  OF FULL SCALE**

POWER RANGE	FREQUENCY BANDS (MHz)	
	950 to 1100	1100 to 1260
1 W	1J-950	1J-1100
2.5 W	2.5J-950	2.5J-1100
5 W	5J-950	5J-1100
10 W	10J-950	10J-1100
25 W	25J-950	25J-1100
50 W	50J-950	50J-1100
100 W	100J-950	100J-1100
250 W	250J-950	250J-1100
500 W	500J-950	500J-1100
1000 W	1000J-950	1000J-1100
2500 W	2500J-950	2500J-1100
5000 W	5000J-950	5000J-1100

**TABLE 4 LOW-FREQUENCY ELEMENTS**

POWER RANGE	FREQUENCY BANDS (MHz)
	.45 to 2.5
1000 W	1000P
2500 W	2500P
5000 W	5000P
10000 W	10000P



**ELEMENT SELECTION GUIDE**

MODEL	TABLE(S)	MODEL	TABLE(S)
3128A	1, 2, 3, 4, 6, 13, 14	4391A	1, 2, 3, 4, 5, 6, 13, 14
3170B	1, 2, 3, 4, 6, 13, 14	4410A, 4412A	13
43	1, 2, 3, 4, 6, 13, 14	4431	1, 2, 3, 4, 6, 13, 14
43P	1, 2, 3, 4, 5, 6, 13	4526	1, 2, 3, 4, 6, 13, 14
4314C	1, 2, 3, 4, 5, 6, 13, 14	4527	2 MHz to 512 MHz elements in 1, 2, 6, 13, 14

**Plug-In Elements**

**FOR 7/8 IN LINE SECTIONS & WATTMETERS**

**TABLE 5 PULSE-POWER ELEMENTS, (PEAK ONLY) ±8% OF FULL SCALE**

POWER RANGE	FREQUENCY BANDS (MHz)					
	2 to 30	25 to 60	50 to 125	100 to 250	400 to 800	800 to 1000
500 W	—	—	—	—	—	—
1000 W	—	—	—	—	—	—
2500 W	—	2500A	2500B	2500C	2500E-400	2500E-800
5000 W	—	5000A	5000B	5000C	5000E-400	5000E-800
10000 W	10000H	—	10000B	—	10000E-400	10000E-800

Refer to "Transmission Power Rating Chart" for max power ratings. Elements are capable of reading peak and average power.

**TABLE 6 MILLIWATT ELEMENTS**

POWER RANGE	FREQUENCY BANDS (MHz)									
	40 to 50	72 to 76	108 to 136	135 to 175	320 to 340	328 to 336	400 to 420	420 to 450	450 to 470	800 to 1000
100 mW	—	430-2	430-57	430-86	430-205	430-3	430-7	430-208	430-8	430-263

POWER RANGE	FREQUENCY BANDS (MHz)									
	72 to 76	88 to 108	105 to 120	116 to 126	130 to 150	190 to 210	329 to 336	450 to 470	800 to 1000	
250 mW	430-22	430-217	430-20	430-48	430-13	430-65	430-16	430-61	430-264	

POWER RANGE	FREQUENCY BANDS (MHz)													
	72 to 76	88 to 108	105 to 120	120 to 136	136 to 150	240 to 290	290 to 340	329 to 336	340 to 360	350 to 400	400 to 450	450 to 500	600 to 800	800 to 1000
500 mW	430-33	430-247	430-26	430-248	430-249	430-27	430-253	430-28	430-157	430-254	430-255	430-256	430-258	430-265

**TABLE 13 NONDIRECTIONAL SAMPLER ELEMENTS FOR QC-TYPE OR 7/8 IN EIA LINE**

MODEL	FREQUENCY BAND (MHz)	NOMINAL COUPLING	MAX MAIN LINE POWER
4274-025	25 to 1000	-50 dB ±2 dB (-66 dB @ 2 MHz)	500 W
4274-050	100 to 400	-35 to -48 dB (±1 dB) Adjustable)	500 W



MADE IN USA

## ELEMENT SELECTION GUIDE

MODEL	TABLE(S)	MODEL	TABLE(S)
3128A	1, 2, 3, 4, 6, 13, 14	4391A	1, 2, 3, 4, 5, 6, 13, 14
3170B	1, 2, 3, 4, 6, 13, 14	4410A, 4412A	13
43	1, 2, 3, 4, 6, 13, 14	4431	1, 2, 3, 4, 6, 13, 14
43P	1, 2, 3, 4, 5, 6, 13	4526	1, 2, 3, 4, 6, 13, 14
4314C	1, 2, 3, 4, 5, 6, 13, 14	4527	2 MHz to 512 MHz elements in 1, 2, 6, 13, 14

## Directional Coupler Elements

### FOR RIGID LINE SECTIONS & WATTMETERS

Coupler elements used for RF sampling. The wattmeter display does not read when these elements are installed.

**TABLE 14 DIRECTIONAL COUPLER ELEMENTS FOR QC-TYPE OR 7/8 IN EIA LINE**

MODEL	FREQUENCY BAND (MHz)	NOMINAL COUPLING	MAX MAIN LINE POWER
400-50	50 to 100	-40 dB	-
400-75	75 to 150	-40 dB	-
400-125	125 to 250	-40 dB	1 kW
400-225	225 to 450	-40 dB	1 kW
400-400	400 to 800	-40 dB	1 kW
400-750	750 to 1250	-40 dB	1 kW

**TABLE 15 DIRECTIONAL COUPLER ELEMENTS FOR 1 5/8 IN EIA LINE**

MODEL	FREQUENCY BAND (MHz)	NOMINAL COUPLING	MAX MAIN LINE POWER
501-50	50 to 100	-50 dB	10 kW
501-75	75 to 150	-50 dB	10 kW
501-125	125 to 250	-50 dB	10 kW
501-225	225 to 450	-50 dB	10 kW
501-400	400 to 800	-50 dB	5 kW

NOTE: For use in any line section including BPME

**TABLE 16 DIRECTIONAL COUPLER ELEMENTS FOR 3 1/8 IN EIA LINE**

MODEL	FREQUENCY BAND (MHz)	NOMINAL COUPLING	MAX MAIN LINE POWER
553-50	50 to 100	-55 dB	25 kW
553-75	75 to 150	-55 dB	25 kW
553-125	125 to 250	-55 dB	25 kW
553-401	400 to 800	-55 dB	15 kW

**TABLE 17 DIRECTIONAL COUPLER ELEMENTS FOR 6 1/8 IN EIA LINE**

MODEL	FREQUENCY BAND (MHz)	NOMINAL COUPLING	MAX MAIN LINE POWER
606-50	50 to 100	-60 dB	60 kW
606-400	400 to 870	-60 dB	60 kW





MADE IN USA

## ELEMENT SELECTION GUIDE

MODEL	TABLE(S)
3127A	1 5/8 A, 3 1/8 A
3127-040	1 5/8 A, 3 1/8 A, 4 1/16 A
3127-075	1 5/8 B
6810-220	1 5/8 A, 3 1/8 A
6810-230	1 5/8 B

## Plug-In Elements

### FOR RIGID LINE SECTIONS

TABLE 1 5/8 A STANDARD ELEMENTS 100  $\mu$ A

POWER RANGE	FREQUENCY BANDS (MHz)	
	2 to 30	50 to 125
100 W	—	100B1
250 W	—	250B1
500 W	—	500B1
1000 W	1000H1	1000B1
2500 W	2500H1	2500B1
5000 W	5000H1	5000B1
10 kW	10KH1	10KB1
25 kW	—	25KB1

TABLE 1 5/8 AA STANDARD ELEMENTS 30  $\mu$ A

POWER RANGE	FREQUENCY BANDS (MHz)	
	2 to 30	50 to 125
100 W	—	100B12
250 W	—	250B12
500 W	500H12	500B12
1000 W	1000H12	1000B12
2500 W	2500H12	2500B12
5000 W	5000H12	5000B12
10 kW	10KH12	10KB12
25 kW	25KH12	—

TABLE 1 5/8 B STANDARD ELEMENTS 100  $\mu$ A

POWER RANGE	FREQUENCY BANDS (MHz)	
	2 to 30	50 to 125
300 W	—	300B1
600 W	—	600B1
1500 W	1500H1	1500B1
3000 W	3000H1	3000B1
6000 W	6000H1	6000B1
15 kW	15KH1	15KB1
50 kW	50KH1	—



## ELEMENT SELECTION GUIDE

MODEL	TABLE(S)
3127A	1 5/8 A, 3 1/8 A
3127-040	1 5/8 A, 3 1/8 A, 4 1/16 A
3127-075	1 5/8 B
6810-220	1 5/8 A, 3 1/8 A
6810-230	1 5/8 B

## Plug-In Elements

### FOR RIGID LINE SECTIONS

TABLE 3 1/8 A STANDARD ELEMENTS 100  $\mu$ A

POWER RANGE	FREQUENCY BANDS (MHz)		
	2 to 30	50 to 125	100 to 250
100 W	—	100B3	—
250 W	—	250B3	250C3
500 W	—	500B3	—
1000 W	—	1000B3	1000C3
2500 W	2500H3	2500B3	2500C3
5000 W	5000H3	5000B3	5000C3
1.5 kW	—	1500B3	—
10 kW	10KH3	10KB3	10KC3
15 kW	—	15KB3	—
25 kW	25KH3	25KB3	25KC3
50 kW	50KH3	50KB3	—
100 kW	100KH3	—	—

# RF LOADS & ATTENUATORS

## Rugged and Reliable Solutions for Low to High Power Attenuation and Termination



MADE IN USA ★

CONDUCTION-COOLED LOADS

Page 81



CONVECTION-COOLED LOADS

Page 82 - 83



MADE IN USA ★

OIL-COOLED LOADS

Page 84 - 85



MADE IN USA ★

MARKET SPECIFIC LOADS

Page 86



MADE IN USA ★

WATER-COOLED LOADS

Page 87



MADE IN USA ★

DIGITAL AIR-COOLED LOADS

Page 88 - 89



MADE IN USA ★

MODULOADS

Page 90



MADE IN USA ★

OIL CONVECTION-COOLED  
ATTENUATORS

Page 91



CONVECTION-COOLED  
ATTENUATORS

Page 92 - 93



# Attenuators

Bird manufactures a broad spectrum of RF power attenuators from 2 W to 4000W. Our resistive product portfolio includes air-cooled, water-cooled, oil-dielectric, convection cooled, and conduction cooled RF units.

## 1 WHAT IS AN ATTENUATOR?

Bird's Convection cooled RF Attenuators are components that will reduce the amplitude level of an incoming signal and are used to protect systems from receiving a signal with a power level that is too high to process. Attenuators are a valuable and reliable accessory for reducing power levels, for isolating components under test, for harmonic signal analysis, and as comparison standards. Convection RF Attenuators feature a self-cooling design, frequencies up to 18GHz and fully shielded.

## 2 ATTENUATOR SELECTION CRITERIA

- **Attenuation Value** - most important of all is attenuation factor. Attenuators are available from 0 dB to 40 dB and above depending on applications. Attenuation is how much power is removed from the signal before the output.
- **Power Rating (Watts)** - it is recommended to pick one with higher power handling capability than your required power
- **Convection Product Type**
  1. **A** = input and output connector on the same side of the heatsink
  2. **SA and WA** = connectors in-line, or straight through the heatsink
- **Connector Gender** - Male or Female combinations
- **Connector Type** - SMA, BNC, N, TNC or IEC 7/16





# RF Loads

Bird manufactures a broad spectrum of devices from one watt to eighty kilowatts. Our resistive product portfolio includes air-cooled, water-cooled, oil-dielectric, convection cooled, and conduction cooled RF attenuators and RF loads.

## 1 WHAT IS A RF LOAD?

RF Loads come in various shapes and sizes and provide one purpose – convert RF electrical energy into a form of energy that can be dissipated efficiently, economically, and safely. The purpose of a load or termination (also known as a “dummy load”) is to absorb RF energy and turn it into heat. Many times, the load takes the place of an antenna during transmitter testing.

## 2 OTHER APPLICATIONS WHERE TERMINATIONS CAN BE FOUND

- Reject Loads
- Hybrid Combiners
- Isolators / Circulators
- Transmitter Tuning
- System Testing & Calibration

## 3 CONSIDERATION BASICS

Terminations should be properly matched to the characteristic impedance of a transmission line. The termination characteristics of primary concern are operating frequency range, average power handling capability, operating temperature range, VSWR, size and weight. Impedance is typically 50 Ohms unless otherwise stated.

### ▪ Electrical Considerations

1. **Frequency Range** - the exact operating frequency range of each dummy load should be specified
2. **Maximum VSWR** - measure of how well the load is “matched” to the transmission line
3. **Peak to Average Power Ratio** - how much “Instantaneous” power can be absorbed
4. **Power Rating** - the amount of energy (heat) a load can absorb. The average and peak powers are interrelated in that the peak power capacity is a function of the operating temperature which in turn is a function of the average power. These are then impacted by the ambient temperature of the cooling medium (air or water).

### ▪ Mechanical considerations - Connectors or Flanges, Dimensions, mounting provisions, Coolant

### ▪ Environmental Consideration - Ambient Temperature Range, Coolant Flow, Coolant Temp, Humidity, Shock, Vibration and Altitude



## 4 WHAT ARE THE TYPES OF LOADS?

Load types are defined by cooling methods: Convection, Conduction, Oil Cooled, Water Cooled and Forced air (Moduloads). Bird offers power levels from 2 W to 80 kW.



- Convection cooling** describes a termination equipped with a heat sink with cooling fins. A heat sink with cooling fins increases the effective heat exchange toward the environment. The heat sink is characterized by its thermal resistance or by the increase of surface temperature per watt (in °C per W). The shorter this value is, the greater the power will be.



- Conduction cooling** describes the termination heat transfer by means of molecular agitation within the material without any motion of the material as a whole, this is considered a passive cooling device. Important considerations are ambient temperature and how much free airflow is available and the amount of heat needed to dissipate.



- Water-cooled loads** use pressurized water of proper temperature and flow rate to carry heat away from the resistive element. The water-cooling system can be sub-divided into two groups: water that is contained totally inside the resistor and water that flows on both the inside and outside of the resistor. Advantages include superior efficiency, small size and common for calorimetry due to containment of heat flux paths. Typical mixtures are 50/50 water/glycol mixture or potable water.



- Moduload** is for those installations that do not have water access or good water quality but still desire high power capabilities, Bird manufactures a water-cooled load (Moduload series) that is completely self-contained.



- Oil-dielectric loads** surround the resistive element with oil, which transfers heat to an exterior, finned shell for dissipation into the surrounding air.



- Air-cooled loads** use the properties of moving air to transfer the heat away from the resistive element. Typically, these loads are equipped with fans to move the air past the resistors. They are virtually maintenance free, handle extremely high peak powers and high operating temperatures. They do have a large footprint which also limits the frequency.

## Typical Peak Power Ratings For Bird Loads

Understanding your application and criteria for the heat sink when using a conductive load for proper operation will assure your needs are met in thermal performance and will help eliminate any unwanted effects in the entire system.

### OIL-COOLED LOADS

MODEL	POWER RATING	PULSE WIDTH (MICROSECONDS)					FREQUENCY RANGE	VSWR
		1 $\mu$	10 $\mu$	100 $\mu$	1000 $\mu$	5000 $\mu$		
8135	150 W	10 kW	8 kW	5.75 kW	3.5 kW	2 kW	DC to 1 GHz 1 to 2.5 GHz 2.5 to 4 GHz	1.1:1 1.2:1 1.3:1
8201	500 W	200 kW	150 kW	105 kW	57 kW	25 kW	DC to 1 GHz 1 to 2.5 GHz	1.1:1 1.25:1
8251	1 kW	200 kW	150 kW	105 kW	57 kW	25 kW	DC to 1 GHz 1 to 2 GHz 2 to 2.4 GHz	1.1:1 1.25:1 1.3:1
8890 Series	2.5 kW	150 kW	115 kW	80 kW	54 kW	22 kW	DC to 1 GHz 1 to 2 GHz 2 to 2.4 GHz	1.1:1 1.25:1 1.3:1
8920 Series	5 kW	150 kW	115 kW	80 kW	54 kW	22 kW	DC to 1 GHz	1.1:1
8930 Series	10 kW	150 kW	120 kW	85 kW	55 kW	30 kW	DC to 400 MHz 400 MHz to 1 GHz	1.15:1 1.2:1

Note: Duty factor should be such that the average power rating of the load is never exceeded.

### WATER-COOLED LOADS

MODEL	POWER RATING	PULSE WIDTH (MICROSECONDS)					FREQUENCY RANGE	VSWR
		1 $\mu$	10 $\mu$	100 $\mu$	1000 $\mu$	5000 $\mu$		
8730 Series	10 kW	100 kW	77 kW	50 kW	32 kW	16 kW	DC to 1 GHz	1.1:1
8740 Series	20 kW	250 kW	190 kW	135 kW	75 kW	35 kW	1 kHz to 900 MHz	1.1:1
8750 Series	30 kW	250 kW	190 kW	135 kW	75 kW	40 kW	1 kHz to 900 MHz	1.1:1
8760 Series	40 kW	250 kW	197 kW	145 kW	90 kW	55 kW	1 kHz to 900 MHz	1.1:1
8770 Series	50 kW	250 kW	197 kW	145 kW	97 kW	65 kW	1 kHz to 900 MHz	1.1:1
8790 Series	80 kW	250 kW	210 kW	170 kW	130 kW	100 kW	1 kHz to 800 MHz	1.15:1

Note: Duty factor should be such that the average power rating of the load is never exceeded.





## RF Power Loads

### CONDUCTION-COOLED

Dry Conduction-Cooled RF Power Loads are world-renowned for their high-quality, robust construction and conservative power ratings. The use of non-magnetic materials and plating provide safety when used in applications with high magnetic fields such as MRI.

### LOAD CONFIGURATION GUIDE

POWER RATING	PRODUCT TYPE	CONNECTOR GENDER	CONNECTORS*
See selection guide	<b>T, WT</b> = Convection-cooled <b>CT</b> = Conduction-cooled <b>ST</b> = Square convection-cooled	<b>F</b> = Female <b>M</b> = Male	<b>A</b> = SMA <b>B</b> = BNC <b>N</b> = N <b>T</b> = TNC <b>E</b> = IEC 7/16

\*Call for custom connector options not shown in this catalog

**Example:** 25-CT-FA= Model 25-CT, 25 W, conduction-cooled load with female SMA connectors.

Note: Not all combinations are valid. If assistance is needed consult the factory to define the model that is right for you.

### LOAD SELECTION GUIDE

MODEL	POWER RATING	CONNECTORS	FREQUENCY RANGE & VSWR	DIMENSIONS	WEIGHT
25-CT	25 W	SMA	DC to 1 GHz @ 1.15:1 max 1 to 3 GHz @ 1.25:1 max	0.9 in x 1.0 in x 0.5 in (23 x 26 x 13 mm)	0.4 oz (12 g)
50-CT	50 W	SMA	DC to 3 GHz @ 1.15:1 max 3 to 6 GHz @ 1.25:1 max	0.8 in x 0.9 in x 0.4 in (21 x 23 x 11 mm)	1.1 oz (32 g)
100-CT	100 W	SMA	DC to 2 GHz @ 1.15:1 max 2 to 3 GHz @ 1.25:1 max	1.4 in x 1.4 in x 0.6 in (36 x 36 x 16 mm)	1.0 oz (30 g)
150-CT	150 W	N	DC to 2 GHz @ 1.15:1 max 2 to 3 GHz @ 1.25:1 max	1.9 in x 1.2 in x 1.1 in (49 x 31 x 28 mm)	2.2 oz (63 g)
150-CT	150 W	SMA	DC to 2 GHz @ 1.15:1 max 2 to 3 GHz @ 1.25:1 max	2.1 in x 2.1 in x 0.6 in (54 x 54 x 16 mm)	2.2 oz (63 g)
151-CT	150 W	N	DC to 1 GHz @ 1.10:1 max 1 to 4 GHz @ 1.25:1 max	2.0 in x 2.0 in x 1.1 in (51 x 51 x 28 mm)	2.2 oz (63 g)
250-CT	250 W	BNC, N	DC to 1 GHz @ 1.10:1 max 1 to 2.4 GHz @ 1.25:1 max	2.5 in x 2.2 in x 1.1 in (64 x 56 x 28 mm)	5.2 oz (148 g)
250-CT	250 W	SMA	DC to 2 GHz @ 1.15:1 max 2 to 3 GHz @ 1.25:1 max	2.1 in x 2.1 in x 0.6 in (54 x 54 x 16 mm)	5.2 oz (148 g)
300-CT	300 W	N	DC to 1 GHz @ 1.10:1 max 1 to 3 GHz @ 1.25:1 max	4.8 in x 2.0 in x 1.2 in (122 x 51 x 31 mm)	12 oz (340 g)
500-CT	500 W	SMA, BNC, N, TNC	DC to 1 GHz @ 1.15:1 max 1 to 3 GHz @ 1.30:1 max	2.7 in x 2.0 in x 1.2 in (69 x 51 x 31 mm)	8.2 oz (233 g)

### PRODUCT FEATURES

- Ultra-compact, lightweight design
- Economical design
- Fully shielded against production of extraneous radiation
- Load requires no AC power
- Requires a heatsink capable of maintaining a case temperature at or below 100°C

### SYSTEM

<b>Coolant Method</b>	Dry, conduction-cooled
<b>Impedance</b>	50 Ohms
<b>AC Power</b>	None
<b>Finish</b>	Tri-alloy
<b>Operating Position</b>	Any

### ENVIRONMENTAL

<b>Water Inlet Temperature</b>	-40 °C to 40 °C (-40 °F to 104 °F)
--------------------------------	------------------------------------



**PRODUCT FEATURES**

- Self-cooling design, needs no cooling plate
- Frequencies up to 18 GHz
- Load requires no AC power
- Rugged construction
- Broadband operation

**SYSTEM**

Coolant Method	Dry, convection-cooled
Impedance	50 Ohms
AC Power	None except 1500 W models require 115/230V AC power
Operating Position	Any

**ENVIRONMENTAL**

Ambient Temperature	-40 °C to 40 °C (-40 °F to 104 °F)
Humidity	95% non-condensing

**RF Power Loads**  
**CONVECTION-COOLED**

Bird manufactures a broad line of Convection-Cooled RF Loads. They are known for their high-quality, rugged construction and conservative power ratings. These loads are fully shielded against production of extraneous radiation and the self-cooling design needs no cooling plate.

**LOAD CONFIGURATION GUIDE**

POWER RATING	PRODUCT TYPE	CONNECTOR GENDER	CONNECTORS*
See selection guide	<b>T, WT</b> = Convection-cooled <b>CT</b> = Conduction-cooled <b>ST</b> = Square convection-cooled	<b>F</b> = Female <b>M</b> = Male	<b>A</b> = SMA <b>B</b> = BNC <b>N</b> = N <b>T</b> = TNC <b>E</b> = IEC 7/16

\*Call for custom connector options not shown in this catalog

**Example: 2-18T-FA** = Model 2-18T, 2 W, convection-cooled load with female SMA connectors.

Note: Not all combinations are valid. If assistance is needed consult the factory to define the model that is right for you.

**LOAD SELECTION GUIDE**

MODEL	POWER RATING	CONNECTORS	FREQUENCY RANGE & VSWR	DIMENSIONS	WEIGHT	FINISH
2-T	2 W	BNC, 7/16 DIN, N, TNC	DC to 1 GHz @ 1.10:1 max 1 to 4 GHz @ 1.25:1 max	2.9 in x 1.4 in dia (74 mm x 36 dia mm)	4.6 oz (131 g)	Tri-Alloy
2-NT	2 W	N	DC to 1 GHz @ 1.10:1 max 1 to 3 GHz @ 1.15:1 max	2.9 in x 1.4 in dia (74 mm x 36 dia mm)	4.6 oz (131 g)	Tri-Alloy
2-18T	2 W	N	DC to 12.4 GHz @ 1.20:1 max 12.4 to 18 GHz @ 1.25:1 max	1.0 in x 0.9 in dia (26 mm x 23 dia mm)	2.0 oz (57 g)	Stainless Steel
5-T	5 W	BNC, 7/16 DIN, N, TNC	DC to 1 GHz @ 1.10:1 max 1 to 4 GHz @ 1.25:1 max	2.9 in x 1.4 in dia (74 mm x 36 dia mm)	4.6 oz (131 g)	Tri-Alloy
5-NT	5 W	N	DC to 1 GHz @ 1.10:1 max 1 to 3 GHz @ 1.15:1 max	2.9 in x 1.4 in dia (74 mm x 36 dia mm)	4.6 oz (131 g)	Tri-Alloy
5-18T	5 W	N	DC to 4 GHz @ 1.15:1 max 4 to 12.4 GHz @ 1.25:1 max 12.4 to 18 GHz @ 1.35:1 max	1.4 in x 0.9 in dia (36 mm x 23 dia mm)	2.0 oz (57 g)	Stainless Steel

\*\*Except models 2-T, 2-NT, and 2-18T

# RF Power Loads **CONVECTION-COOLED**

## LOAD SELECTION GUIDE

MODEL	POWER RATING	CONNECTORS	FREQUENCY RANGE & VSWR	DIMENSIONS	WEIGHT	FINISH
10-T	10 W	N, BNC, 7/16 DIN, TNC, 4.3/10	DC to 1 GHz @ 1.10:1 max 1 to 4 GHz @ 1.15:1 max	2.2 in x 2.3 in dia (56 mm x 59 dia mm)	5.9 oz (168 g)	Black Anodized Aluminum
25-T	25 W	SMA, BNC, 7/16 DIN, N, TNC, 4.1/9.5	DC to 1 GHz @ 1.10:1 max 1 to 4 GHz @ 1.25:1 max	5.3 in x 2.3 in dia (135 mm x 59 dia mm)	7 oz (199 g)	Black Anodized Aluminum
25-6T	25 W	N	DC to 6 GHz @ 1.20:1 max	3.5 in x 2.3 in x 2.3 in (89 mm x 59 mm x 59 mm)	14.0 oz (397 g)	Black Anodized Aluminum
25-18T	25 W	N	DC to 6 GHz @ 1.20:1 max 6 to 12.4 GHz @ 1.30:1 max 12.4 to 18 GHz @ 1.40:1 max	3.5 in x 2.3 in x 2.3 in (89 mm x 59 mm x 59 mm)	14.0 oz (397 g)	Black Anodized Aluminum
50-T	50 W	SMA, BNC, 7/16 DIN, N, TNC, 4.1/9.5	DC to 1 GHz @ 1.10:1 max 1 to 4 GHz @ 1.25:1 max	5.3 in x 2.3 in dia (135 mm x 59 dia mm)	1.3 lb (590 g)	Black Anodized Aluminum
50-NT	50 W	N	DC to 1 GHz @ 1.10:1 max 1 to 3 GHz @ 1.15:1 max	5.3 in x 2.3 in dia (135 mm x 59 dia mm)	1.2 lb (545 g)	Black Anodized Aluminum
50-6T	50 W	N	1 to 6 GHz @ 1.25:1 max	4.0 in x 3.0 in x 3.0 in (102 mm x 77 mm x 77 mm)	1.6 lb (726 g)	Black Anodized Aluminum
50-18T	50 W	N	DC to 6 GHz @ 1.25:1 max 6 to 12.4 GHz @ 1.35:1 max 12.4 to 18 GHz @ 1.45:1 max	4.0 in x 3.0 in x 3.0 in (102 mm x 77 mm x 77 mm)	1.6 lb (726 g)	Black Anodized Aluminum
75-T	75 W	BNC, 7/16 DIN, N	DC to 1 GHz @ 1.10:1 max 1 to 4 GHz @ 1.25:1 max	7.2 in x 2.3 in dia (183 mm x 59 dia mm)	1.5 lb (682 g)	Black Anodized Aluminum
100-T	100 W	BNC, 7/16 DIN, N, TNC	DC to 1 GHz @ 1.10:1 max 1 to 3 GHz @ 1.25:1 max	6.8 in x 6.4 in x 2.6 in (173 mm x 163 mm x 67 mm)	3.6 lb (1.6 kg)	Stainless Steel
100-ST	100 W	BNC, 7/16 DIN, N, TNC	DC to 1 GHz @ 1.10:1 max 1 to 4 GHz @ 1.25:1 max	7.4 in x 2.8 in x 2.8 in (188 mm x 72 mm x 72 mm)	2.7 lb (1.2 kg)	Black Anodized Aluminum
100-NST	100 W	N	DC to 1 GHz @ 1.10:1 max 1 to 3 GHz @ 1.15:1 max	7.3 in x 2.8 in x 2.8 in (186 mm x 72 mm x 72 mm)	2.7 lb (1.2 kg)	Black Anodized Aluminum
100-6T	100 W	N	DC to 2 GHz @ 1.20:1 max 2 to 4 GHz @ 1.30:1 max 4 to 6 GHz @ 1.40:1 max	5.5 in x 3.5 in x 3.8 in (140 mm x 89 mm x 97 mm)	2.2 lb (1.0 kg)	Black Anodized Aluminum
150-T	150 W	BNC, N	DC to 1 GHz @ 1.10:1 max 1 to 3.0 GHz @ 1.25:1 max	6.8 in x 11.5 in x 2.6 in (173 mm x 293 mm x 67 mm)	6.0 lb (2.8 kg)	Black Anodized Aluminum
150-ST	150 W	N	DC to 1 GHz @ 1.10:1 max 1 to 3.0 GHz @ 1.25:1 max	8.1 in x 4.0 in x 4.0 in (206 mm x 102 mm x 102 mm)	5.0 lb (2.3 kg)	Black Anodized Aluminum
150-WT	150 W	N	DC to 1 GHz @ 1.10:1 max 1 to 3.0 GHz @ 1.25:1 max	4.9 in x 5.4 in x 4.8 in (125 mm x 138 mm x 122 mm)	2.5 lb (1.2 kg)	Black Anodized Aluminum
300-T	300 W	N	DC to 1 GHz @ 1.10:1 max 1 to 2.4 GHz @ 1.25:1 max	7.4 in x 5.4 in x 10.9 in (188 mm x 138 x 277 mm)	11.5 lb (5.3 kg)	Black Anodized Aluminum
300-WT	300 W	7/16 DIN, N	DC to 1 GHz @ 1.10:1 max 1 to 2.4 GHz @ 1.25:1 max	8.2 in x 5.4 in x 4.8 in (209 mm x 138 x 122 mm)	4.7 lb (2.2 kg)	Black Anodized Aluminum
500-WT	500 W	7/16 DIN, N	DC to 1 GHz @ 1.10:1 max 1 to 2.4 GHz @ 1.25:1 max	11.0 in x 5.4 in x 4.8 in (280 mm x 138 mm x 122 mm)	7.8 lb (3.6 kg)	Black Anodized Aluminum
600-T	600 W	7/16 DIN, N	DC to 1 GHz @ 1.10:1 max 1 to 2.4 GHz @ 1.25:1 max	12.4 in x 9.6 in x 7.4 in (315 mm x 244 mm x 188 mm)	21.5 lb (9.8 kg)	Black Anodized Aluminum
1000-T	1 kW	N	DC to 1 GHz @ 1.15:1 max 1 to 2.4 GHz @ 1.25:1 max	12.3 in x 9.6 in x 12.8 in (313 mm x 244 mm x 326 mm)	26.5 lb (12.0 kg)	Black Anodized Aluminum
1000-WT	1 kW	7/16 DIN, N	DC to 1 GHz @ 1.15:1 max 1 to 2.4 GHz @ 1.25:1 max	18.5 in x 10.6 in x 4.8 in (470 mm x 270 mm x 122 mm)	26.5 lb (12.0 kg)	Black Anodized Aluminum
1500-WT**	1.5 kW	7/16 DIN, N	DC to 1 GHz @ 1.10:1 max 1 to 2.4 GHz @ 1.25:1 max	20 in x 10.6 in x 6.0 in (508 mm x 270 mm x 152 mm)	30.0 lb (13.6 kg)	Black Anodized Aluminum
1500-WA**	1.5 kW	N	DC to 1 GHz @ 1.10:1 max 1 to 2.4 GHz @ 1.25:1 max	20.4 in x 10.7 in x 5.9 in (519 mm x 272 mm x 150 mm)	30.0 lb (13.6 kg)	Black Anodized Aluminum

\*\*1.5 kW Models require 115/230V AC Power





## RF Loads

### OIL-COOLED

Bird's Oil-Cooled RF Loads are self-contained high-power 50 Ohm coaxial transmission line terminations requiring no outside power source or additional equipment. These units provide accurate, dependable, and practically non-reflective termination for testing and adjusting transmitters under non-radiating conditions. The loads consist essentially of a cylindrical film type resistor immersed in a dielectric coolant. The resistor, individually selected for its accuracy, is enclosed in a special tapered housing which provides a linear reduction in surge impedance directly proportional to the distance along the resistor.

## PRODUCT FEATURES

- Self-contained cooling system that includes cooling fans for higher power models
- Capable of up to 10 dB peak to average power ratios
- Wide range of available RF input connectors
- Compact design
- Broadband operation

## SYSTEM

<b>Coolant Method</b>	8135, 8201, 8251: Refined mineral oil All Others: Silicone oil
<b>Impedance</b>	50 Ohms
<b>Finish</b>	Gray powder coat
<b>AC Power</b>	None except 1500 W models require 115/230V AC power
<b>Operating Position</b>	Vertical

## ENVIRONMENTAL

<b>Ambient Temperature</b>	-40 °C to 45 °C (-40 °F to 113 °F)
<b>Storage Temperature</b>	-40 °C to 45 °C (-40 °F to 113 °F)
<b>Humidity</b>	95% non-condensing
<b>Altitude</b>	1520 m (5000 ft)

## CERTIFICATIONS

<b>Safety</b>	EMC EN 61326-1:2006 (units w/blowers) and Safety EN 61010-1:2001 (all units)
---------------	---

## LOAD SELECTION GUIDE

MODEL	POWER RATING	CONNECTORS	COOLING METHOD	FREQ. RANGE & VSWR	DIMENSIONS	WEIGHT
8135	150 W	QC - N(f)	Convection	DC to 1 GHz @ 1.1:1 max 1 to 2.5 GHz @ 1.2:1 max 2.5 to 4 GHz @ 1.3:1 max	9.6 in x 4 in x 6.5 in (242 mm x 102 mm x 164 mm)	6.0 lb (2.7 kg)
8141	250 W	QC - N(f)	Convection	DC to 1 GHz @ 1.1:1 max 1 to 1.8 GHz @ 1.2:1 max 1.8 to 2.5 GHz @ 1.3:1 max	9.6 in x 4 in x 6.5 in (242 mm x 102 mm x 164 mm)	10 lb (4.5 kg)
8201	500 W	QC - N(f)	Convection	DC to 1 GHz @ 1.1:1 max 1 to 2.5 GHz @ 1.25:1 max	16.8 in x 6 in x 8.5 in (427 mm x 151 mm x 216 mm)	20 lb (9.1 kg)
8401	600 W	QC - N(f)	Convection	DC to 1 GHz @ 1.1:1 max 1 to 2.8 GHz @ 1.2:1 max 2.8 to 3 GHz @ 1.35:1 max	16.2 in x 6 in x 8.5 in (408 mm x 151 mm x 216 mm)	20 lb (9.1 kg)
8251	1 kW	QC - N(f)	Convection	DC to 1 GHz @ 1.1:1 max 1 to 2 GHz @ 1.25:1 max 2 to 2.4 GHz @ 1.3:1 max	18 in x 6 in x 8.5 in (455 mm x 151 mm x 216 mm)	25 lb (11.5 kg)
8860	1.5 kW	QC - N(f)	Convection	DC to 1 GHz @ 1.1:1 max 1 to 2 GHz @ 1.25:1 max	19.5 in x 7.5 in x 13.2 in (496 mm x 184 mm x 334 mm)	32 lb (14.5 kg)
8861	1.5 kW	1 5/8 in EIA Unflanged	Convection	DC to 1 GHz @ 1.1:1 max 1 to 2 GHz @ 1.25:1 max	19.5 in x 7.5 in x 13.2 in (496 mm x 184 mm x 334 mm)	32 lb (14.5 kg)
8862	1.5 kW	1 5/8 in EIA Flanged	Convection	DC to 1 GHz @ 1.1:1 max 1 to 2 GHz @ 1.25:1 max	19.5 in x 7.5 in x 13.2 in (496 mm x 184 mm x 334 mm)	32 lb (14.5 kg)

# RF Loads **OIL-COOLED**

## LOAD SELECTION GUIDE

MODEL	POWER RATING	CONNECTORS	COOLING METHOD	FREQ. RANGE & VSWR	DIMENSIONS	WEIGHT
8890-300	2.5 kW	QC - LC(f)	Convection	DC to 1 GHz @ 1.1 max 1 to 2 GHz @ 1.25:1 max 2 to 2.4 GHz @ 1.3 max	25.2 in x 7.5 in x 17.2 in (638 mm x 191 mm x 437 mm)	59 lb (27 kg)
8891-300	2.5 kW	3 1/8 in EIA Flanged	Convection	DC to 1 GHz @ 1.1:1 max 1 to 2 GHz @ 1.25:1 max 2 to 2.4 GHz @ 1.3 max	25.2 in x 7.5 in x 17.2 in (638 mm x 191 mm x 437 mm)	59 lb (27 kg)
8892-300	2.5 kW	1 5/8 in EIA Flanged	Convection	DC to 1 GHz @ 1.1:1 max 1 to 2 GHz @ 1.25:1 max 2 to 2.4 GHz @ 1.3 max	25.2 in x 7.5 in x 17.2 in (638 mm x 191 mm x 437 mm)	59 lb (27 kg)
8895-300	2.5 kW	1 5/8 in EIA Unflanged	Convection	DC to 1 GHz @ 1.1:1 max 1 to 2 GHz @ 1.25:1 max 2 to 2.4 GHz @ 1.3 max	25.2 in x 7.5 in x 17.2 in (638 mm x 191 mm x 437 mm)	59 lb (27 kg)
8890-315	5 kW	QC - LC(f)	115 VAC Fan	DC to 1 GHz @ 1.1:1 max 1 to 2 GHz @ 1.25:1 max 2 to 2.4 GHz @ 1.3 max	25.2 in x 7.4 in x 22.7 in (638 mm x 187 mm x 560 mm)	59 lb (27 kg)
8890-320	5 kW	QC - LC(f)	230 VAC Fan	DC to 1 GHz @ 1.1:1 max 1 to 2 GHz @ 1.25:1 max 2 to 2.4 GHz @ 1.3 max	25.2 in x 7.4 in x 22.7 in (638 mm x 187 mm x 560 mm)	59 lb (27 kg)
8891-315	5 kW	3 1/8 in EIA Flanged	115 VAC Fan	DC to 1 GHz @ 1.1:1 max 1 to 2 GHz @ 1.25:1 max 2 to 2.4 GHz @ 1.3 max	25.2 in x 7.4 in x 22.7 in (638 mm x 187 mm x 560 mm)	59 lb (27 kg)
8891-320	5 kW	3 1/8 in EIA Flanged	230 VAC Fan	DC to 1 GHz @ 1.1:1 max 1 to 2 GHz @ 1.25:1 max 2 to 2.4 GHz @ 1.3 max	25.2 in x 7.4 in x 22.7 in (638 mm x 187 mm x 560 mm)	59 lb (27 kg)
8892-315	5 kW	1 5/8 in EIA Flanged	115 VAC Fan	DC to 1 GHz @ 1.1:1 max 1 to 2 GHz @ 1.25:1 max 2 to 2.4 GHz @ 1.3 max	25.2 in x 7.4 in x 22.7 in (638 mm x 187 mm x 560 mm)	59 lb (27 kg)
8892-320	5 kW	1 5/8 in EIA Flanged	230 VAC Fan	DC to 1 GHz @ 1.1:1 max 1 to 2 GHz @ 1.25:1 max 2 to 2.4 GHz @ 1.3 max	25.2 in x 7.4 in x 22.7 in (638 mm x 187 mm x 560 mm)	59 lb (27 kg)
8895-315	5 kW	1 5/8 in EIA Unflanged	115 VAC Fan	DC to 1 GHz @ 1.1:1 max 1 to 2 GHz @ 1.25:1 max 2 to 2.4 GHz @ 1.3 max	25.2 in x 7.4 in x 22.7 in (638 mm x 187 mm x 560 mm)	59 lb (27 kg)
8895-320	5 kW	1 5/8 in EIA Unflanged	230 VAC Fan	DC to 1 GHz @ 1.1:1 max 1 to 2 GHz @ 1.25:1 max 2 to 2.4 GHz @ 1.3 max	25.2 in x 7.4 in x 22.7 in (638 mm x 187 mm x 560 mm)	59 lb (27 kg)
8921	5 kW	QC - LC(f)	Convection	DC to 1 GHz @ 1.1:1 max	32.8 in x 9.5 in x 26.9 in (832 mm x 241 mm x 681 mm)	119 lb (54 kg)
8922	5 kW	1 5/8 in EIA Flanged	Convection	DC to 1 GHz @ 1.1:1 max	32.8 in x 9.5 in x 26.9 in (832 mm x 241 mm x 681 mm)	119 lb (54 kg)
8926	5 kW	3 1/8 in EIA Flanged	Convection	DC to 1 GHz @ 1.1:1 max	32.8 in x 9.5 in x 26.9 in (832 mm x 241 mm x 681 mm)	119 lb (54 kg)
8931-115	10 kW	QC - LC(f)	115 VAC Fan	DC to 400 MHz @ 1.15:1 max 400 MHz to 1 GHz @ 1.2:1 max	32.8 in x 9.5 in x 33.4 in (832 mm x 241 mm x 847 mm)	142 lb (65 kg)
8931-230	10 kW	QC - LC(f)	230 VAC Fan	DC to 400 MHz @ 1.15:1 max 400 MHz to 1 GHz @ 1.2:1 max	32.8 in x 9.5 in x 33.4 in (832 mm x 241 mm x 847 mm)	142 lb (65 kg)
8932-115	10 kW	1 5/8 in EIA Flanged	115 VAC Fan	DC to 400 MHz @ 1.15:1 max 400 MHz to 1 GHz @ 1.2:1 max	32.8 in x 9.5 in x 33.4 in (832 mm x 241 mm x 847 mm)	142 lb (65 kg)
8932-230	10 kW	1 5/8 in EIA Flanged	230 VAC Fan	DC to 400 MHz @ 1.15:1 max 400 MHz to 1 GHz @ 1.2:1 max	32.8 in x 9.5 in x 33.4 in (832 mm x 241 mm x 847 mm)	142 lb (65 kg)
8936-115	10 kW	3 1/8 in EIA Flanged	115 VAC Fan	DC to 400 MHz @ 1.15:1 max 400 MHz to 1 GHz @ 1.2:1 max	32.8 in x 9.5 in x 33.4 in (832 mm x 241 mm x 847 mm)	142 lb (65 kg)
8936-230	10 kW	3 1/8 in EIA Flanged	230 VAC Fan	DC to 400 MHz @ 1.15:1 max 400 MHz to 1 GHz @ 1.2:1 max	32.8 in x 9.5 in x 33.4 in (832 mm x 241 mm x 847 mm)	142 lb (65 kg)



## Market Specific RF Loads

### OIL-COOLED

Bird's Oil-Cooled RF Loads for Digital Broadcast and Semiconductor Precision applications are self-contained high-power 50 Ohm coaxial transmission line terminations requiring no outside power source or additional equipment. These coaxial load resistors provide accurate, dependable, and practically non-reflective termination for testing and adjusting transmitters under non-radiating conditions.

### PRODUCT FEATURES

- Self-contained cooling system that includes cooling fans for higher power models
- Tuned for optimal performance over target frequency ranges
- Capable of up to 10 dB peak to average power ratios
- Wide range of available RF input connectors
- Compact design

### SYSTEM

<b>Coolant Method</b>	Silicone oil
<b>Impedance</b>	50 Ohms
<b>Finish</b>	Digital Broadcast: Gray powder coat Semiconductor: Black powder coat
<b>AC Power</b>	None except 1.5 kW models require 115/230V AC power
<b>Operating Position</b>	Vertical

### ENVIRONMENTAL

<b>Ambient Temperature</b>	Digital Broadcast: -40 °C to 45 °C (-40 °F to 113 °F) Semiconductor: 5 °C to 40 °C (41 °F to 104 °F)
<b>Storage Temperature</b>	-40 °C to 45 °C (-40 °F to 113 °F)
<b>Humidity</b>	95% non-condensing
<b>Altitude</b>	1520 m (5000 ft)

### DIGITAL BROADCAST LOAD SELECTION GUIDE

MODEL	POWER RATING	CONNECTORS	COOLING METHOD	FREQ. RANGE & VSWR	DIMENSIONS	WEIGHT
8251D	1 kW	1 5/8 in EIA Flanged	Convection	470 to 860 MHz @ 1.065:1 max	17.9 in x 8.5 in x 6 in	25 lb
8251D7-16	1 kW	7/6 Jack, IEC	Convection	470 to 860 MHz @ 1.065:1 max	(455 mm x 216 mm x 151 mm)	(11.5 kg)
8862D	1.5 kW	1 5/8 in EIA Flanged	Convection	470 to 860 MHz @ 1.065:1 max	19.5 in x 7.5 in x 13.2 in	32 lb
					(496 mm x 184 mm x 334 mm)	(14.5 kg)
8891D300	2.5 kW	3 1/8 in EIA Flanged	Convection	470 to 860 MHz @ 1.065:1 max	25.2 in x 7 in x 17.2 in	59 lb
8892D300	2.5 kW	1 5/8 in EIA Flanged	Convection	470 to 860 MHz @ 1.065:1 max	(638 mm x 178 mm x 437 mm)	(27 kg)
8892D320	5 kW	1 5/8 in EIA Flanged	230 VAC Fan	470 to 860 MHz @ 1.065:1 max	25.2 in x 7 in x 17.2 in	73 lb
					(638 mm x 178 mm x 437 mm)	(33 kg)
8922D	5 kW	1 5/8 in EIA Flanged	Convection	470 to 860 MHz @ 1.065:1 max	32.8 in x 9.5 in x 26.9 in	126 lb
8926D	5 kW	3 1/8 in EIA Flanged	Convection	470 to 860 MHz @ 1.065:1 max	(832 mm x 241 mm x 681 mm)	(57 kg)
8927D	5 kW	3 1/8 in EIA Unflanged	Convection	470 to 860 MHz @ 1.065:1 max		
8936D115	10 kW	3 1/8 in EIA Flanged	115 VAC Fan	470 to 860 MHz @ 1.15:1 max	32.8 in x 9.5 in x 33.4 in	142 lb
8936D230	10 kW	3 1/8 in EIA Flanged	230 VAC Fan	470 to 860 MHz @ 1.15:1 max	(832 mm x 241 mm x 847 mm)	(65 kg)

### SEMICONDUCTOR PRECISION LOAD SELECTION GUIDE

MODEL	POWER RATING	CONNECTORS	COOLING METHOD	FREQ. RANGE & VSWR	DIMENSIONS	WEIGHT
8865SC13	1 kW	QC-LC(f)	Convection	DC to 28 MHz @ 1.10:1 max	19.5 in x 7.5 in x 13.2 in	32 lb
					(496 mm x 184 mm x 334 mm)	(14.5 kg)
8890-300SC13	2.5 kW	QC-LC(f)	Convection	DC to 28 MHz @ 1.10:1 max	25.2 in x 7 in x 17.2 in	59 lb
					(638 mm x 178 mm x 437 mm)	(27 kg)
8921SC13	5 kW	QC-LC(f)	Convection	DC to 28 MHz @ 1.10:1 max	32.8 in x 9.5 in x 26.9 in	126 lb
					(832 mm x 241 mm x 681 mm)	(57 kg)
8931-115SC13	10 kW	QC-LC(f)	115 VAC Fan	DC to 28 MHz @ 1.10:1 max	32.8 in x 9.5 in x 33.4 in	142 lb
8931-230SC13	10 kW	QC-LC(f)	230 VAC Fan	DC to 28 MHz @ 1.10:1 max	(832 mm x 241 mm x 847 mm)	(65 kg)
8941-115SC13	15 kW	QC-7/16DIN(f)	115 VAC Fan	DC to 20 MHz @ 1.10:1	43 in x 9.5 in x 33.4 in	236 lb
8941-230SC13	15 kW	QC-7/16DIN(f)	230 VAC Fan	DC to 20 MHz @ 1.10:1	(1092 mm x 241 mm x 847 mm)	(107 kg)



## Econoloads

### WATER-COOLED

Econoloads are designed as a compact, low VSWR and non-radiating termination for high-power transmitter/transmission line systems. It generates almost no ambient heat, making installation space minimal and convenient, in any position. The RF power is converted to heat in the hollow resistive film load resistor and directly absorbed by the water flowing through it.

### LOAD SELECTION GUIDE

MODEL	POWER RATING	CONNECTORS	FREQUENCY RANGE & VSWR	FLOW RATE	DIMENSIONS	WEIGHT
8720	5 kW	1 5/8 in EIA Flanged	DC to 500 MHz @ 1.10:1 max 500 to 900 MHz @ 1.15:1 max 900 to 2000 MHz @ 1.25:1 max	1 GPM (4 LPM) @ 5 °C to 4 GPM (15 LPM) @ 80 °C	8.1 in x 3.5 in dia (204 mm x 89 mm dia)	2 lb 2 oz (964 g)
8726	5 kW	QC - LC(f)	DC to 500 MHz @ 1.10:1 max 500 to 2000 MHz @ 1.25:1 max	1 GPM (4 LPM) @ 5 °C to 4 GPM (15 LPM) @ 80 °C	10.5 in x 1.7 in dia (265 mm x 43 mm dia)	2 lb 8 oz (1.1 kg)
8730A	10 kW	1 5/8 in EIA Flanged	DC to 1 GHz @ 1.10:1 max	4 GPM (15 LPM) @ 5 °C to 6 GPM (23 LPM) @ 60 °C	16.0 in x 4.4 in dia (406 mm x 111 mm dia)	8 lb (3.6 kg)
8731	10 kW	3 1/8 in EIA Flanged	1 kHz to 1 GHz @ 1.10:1 max	4 GPM (15 LPM) @ 5 °C to 6 GPM (23 LPM) @ 60 °C	14.7 in x 5.2 in dia (372 mm x 132 mm dia)	6 lb 4 oz (2.9 kg)
8738A	10 kW	3 1/8 in EIA Unflanged	1 kHz to 1 GHz @ 1.10:1 max	4 GPM (15 LPM) @ 5 °C to 6 GPM (23 LPM) @ 60 °C	16.0 in x 4.4 in dia (406 mm x 111 mm dia)	6 lb (2.8 kg)
8745	20 kW	3 1/8 in EIA Flanged	1 kHz to 900 MHz @ 1.10:1 max	6 GPM (23 LPM) @ 5 °C to 8 GPM (30 LPM) @ 60 °C	19.5 in x 5.2 in dia (495 mm x 132 mm dia)	15 lb 13 oz (7.2 kg)
8746	20 kW	3 1/8 in EIA Unflanged	1 kHz to 900 MHz @ 1.10:1 max	6 GPM (23 LPM) @ 5 °C to 8 GPM (30 LPM) @ 60 °C	19.5 in x 5.2 in dia (495 mm x 132 mm dia)	15 lb 5 oz (7.0 kg)
8755	30 kW	3 1/8 in EIA Flanged	1 kHz to 900 MHz @ 1.10:1 max	7 GPM (26 LPM) @ 5 °C to 9 GPM (34 LPM) @ 60 °C	19.5 in x 5.2 in dia (495 mm x 132 mm dia)	15 lb 13 oz (7.2 kg)
8756	30 kW	3 1/8 in EIA Unflanged	1 kHz to 900 MHz @ 1.10:1 max	7 GPM (26 LPM) @ 5 °C to 9 GPM (34 LPM) @ 60 °C	19.5 in x 5.2 in dia (495 mm x 132 mm dia)	15 lb 5 oz (7.0 kg)
8765	40 kW	3 1/8 in EIA Flanged	1 kHz to 900 MHz @ 1.10:1 max	8 GPM (30 LPM) @ 5 °C to 10 GPM (38 LPM) @ 60 °C	19.5 in x 5.2 in dia (495 mm x 132 mm dia)	15 lb 13 oz (7.2 kg)
8775	50 kW	3 1/8 in EIA Flanged	1 kHz to 900 MHz @ 1.10:1 max	9 GPM (34 LPM) @ 5 °C to 11 GPM (42 LPM) @ 60 °C	19.5 in x 5.2 in dia (495 mm x 132 mm dia)	15 lb 13 oz (7.2 kg)
8776	50 kW	3 1/8 in EIA Unflanged	1 kHz to 900 MHz @ 1.10:1 max	9 GPM (34 LPM) @ 5 °C to 11 GPM (42 LPM) @ 60 °C	19.5 in x 5.2 in dia (495 mm x 132 mm dia)	15 lb 5 oz (7.0 kg)
8792	80 kW	6 1/8 in EIA Flanged	1 kHz to 800 MHz @ 1.15:1 max	9 GPM (34 LPM) @ 5 °C to 12 GPM (46 LPM) @ 60 °C	35.2 in x 8.2 in dia (891 mm x 206 mm dia)	25 lb (11.3 kg)

### PRODUCT FEATURES

- Econoloads are the smallest load design for power dissipation
- Utilizes an external water supply where there is a source of potable water
- Compact size may be carried easily, mounted in any orientation
- Load requires no AC power
- Surface cool to the touch
- Standard EIA RF connections and NPT water connection

### SYSTEM

<b>Coolant Method</b>	Water-cooled
<b>Impedance</b>	50 Ohms
<b>AC Power</b>	None
<b>Operating Position</b>	Any
<b>Waterlines</b>	5 kW, 8720: 1/4 in FPT 5 kW, 8726: 3/4 in hose 10 kW to 80 kW: 3/4 in hose

### ENVIRONMENTAL

<b>Water Inlet Temperature</b>	5 kW: -8 °C to 40 °C (17.6 °F to 104 °F) 10 kW to 80 kW: -5 °C to 60 °C (23 °F to 140 °F)
--------------------------------	--



MADE IN USA

## Digital Air Loads

### DA SERIES AIR-COOLED

DA-Series, Digital Air RF Loads are forced air-cooled loads that provide a fully self-contained and convenient means of dissipating large amounts of analog or digital RF power. Digital Air loads require no plumbing, pumps or complicated installation and setup procedures. The four fan design provides excellent cooling efficiency as well as extremely high reliability.

### LOAD SELECTION GUIDE

VHF LOAD	CONNECTOR	AC POWER	POWER RATING	FREQUENCY RANGE	DIMENSIONS	WEIGHT
DA10V1F15	1 5/8 in Flanged	115 VAC	10 kW	0 to 240 MHz to AM, FM, VHF	23.5 in x 23.5 in x 59 in (597 mm x 597 mm x 1499 mm)	130 lb (58.97 kg)
DA10V1U15	1 5/8 in Unflanged					
DA10V1F30	1 5/8 in Flanged	230 VAC	10 kW	0 to 240 MHz to AM, FM, VHF	23.5 in x 23.5 in x 59 in (597 mm x 597 mm x 1499 mm)	130 lb (58.97 kg)
DA10V1U30	1 5/8 in Unflanged					
DA10V3F15	3 1/8 in Flanged	115 VAC	10 kW	0 to 240 MHz to AM, FM, VHF	23.5 in x 23.5 in x 59 in (597 mm x 597 mm x 1499 mm)	130 lb (58.97 kg)
DA10V3U15	3 1/8 in Unflanged					
DA10V3F30	3 1/8 in Flanged	230 VAC	10 kW	0 to 240 MHz to AM, FM, VHF	23.5 in x 23.5 in x 59 in (597 mm x 597 mm x 1499 mm)	130 lb (58.97 kg)
DA10V3U30	3 1/8 in Unflanged					
DA25V3F15	3 1/8 in Flanged	115 VAC	25 kW	0 to 240 MHz to AM, FM, VHF	27 in x 27 in x 61 in (686 mm x 686 mm x 1549 mm)	160 lb (72.57 kg)
DA25V3U15	3 1/8 in Unflanged					
DA25V3F30	3 1/8 in Flanged	230 VAC	25 kW	0 to 240 MHz to AM, FM, VHF	27 in x 27 in x 61 in (686 mm x 686 mm x 1549 mm)	160 lb (72.57 kg)
DA25V3U30	3 1/8 in Unflanged					
DA25V4U15	4 1/2 in Unflanged	115 VAC	25 kW	0 to 240 MHz to AM, FM, VHF	27 in x 27 in x 61 in (686 mm x 686 mm x 1549 mm)	160 lb (72.57 kg)
DA25V4U30	4 1/2 in Unflanged	230 VAC				

### PRODUCT FEATURES

- Self-contained and convenient means of dissipating large amounts analog, digital, and combined signals
- Excellent VSWR performance with <1.05:1 typical VSWR (1.1:1 max) across rated frequency range
- Handles >13 dB Peak to Average power ratio
- Ductable exhaust and cool-to-the-touch exterior surfaces
- Double shielded against the production of extraneous radiation

### MEASUREMENT

Impedance	50 Ohms nominal
VSWR	1.05:1 typical, 1.10:1 max
VHF (DC-240 MHz)	1.05:1 typical, 1.10:1 max
UHF (470 to 890 MHz)	
Peak to Average Power	>10 dB

### SYSTEM

Cooling Method	Forced air-cooled
Interlock Contact Rating	10 A @ 120 VAC, 5 A @ 250 VAC
Finish	Blue Powder Coat
Power Requirements	115 V/230 V 50/60 Hz

### ENVIRONMENTAL

Operating Temperature	-40 °C to 45 °C (-40 °F to 113 °F)
-----------------------	------------------------------------

### CERTIFICATIONS

CE	EMC: EN 61326-1:2006 and Safety: EN 61010-1:2001
----	---



# Digital Air Loads DA SERIES AIR-COOLED

## LOAD SELECTION GUIDE

UHF LOAD	CONNECTOR	AC POWER	POWER RATING	FREQUENCY RANGE	DIMENSIONS	WEIGHT
DA5F15	3 1/8 in Flanged	115 VAC	5 kW	470 to 890 MHz UHF	17 in x 17 in x 64 in (495 mm x 495 mm x 1740 mm)	100 lb (45.5 kg)
DA5U15	3 1/8 in Unflanged					
DA5F30	3 1/8 in Flanged	230 VAC	5 kW	470 to 890 MHz UHF	17 in x 17 in x 64 in (495 mm x 495 mm x 1740 mm)	100 lb (45.5 kg)
DA5U30	3 1/8 in Unflanged					
DA10F15	3 1/8 in Flanged	115 VAC	10 kW	470 to 890 MHz UHF	19.5 in x 19.5 in x 68.5 in (432 mm x 432 mm x 1608 mm)	130 lb (58.97 kg)
DA10U15	3 1/8 in Unflanged					
DA10F30	3 1/8 in Flanged	230 VAC	10 kW	470 to 890 MHz UHF	19.5 in x 19.5 in x 68.5 in (432 mm x 432 mm x 1608 mm)	130 lb (58.97 kg)
DA10U30	3 1/8 in Unflanged					
DA15F15	3 1/8 in Flanged	115 VAC	15 kW	470 to 890 MHz UHF	25 in x 25 in x 76.5 in (635 mm x 635 mm x 1943 mm)	192 lb (87.09 kg)
DA15U15	3 1/8 in Unflanged					
DA15F30	3 1/8 in Flanged	230 VAC	15 kW	470 to 890 MHz UHF	25 in x 25 in x 76.5 in (635 mm x 635 mm x 1943 mm)	192 lb (87.09 kg)
DA15U30	3 1/8 in Unflanged					
DA25F15	4 1/16 in Myat Flanged	115 VAC	25 kW	470 to 890 MHz UHF	27 in x 27 in x 76.5 in (686 mm x 686 mm x 1943 mm)	245 lb (111.13 kg)
DA25U15	4 1/16 in Myat Unflanged					
DA25F30	4 1/16 in Myat Flanged	230 VAC	25 kW	470 to 890 MHz UHF	27 in x 27 in x 76.5 in (686 mm x 686 mm x 1943 mm)	245 lb (111.13 kg)
DA25U30	4 1/16 in Myat Unflanged					
DA25 to 4U15	4 1/2 in IEC Unflanged	115 VAC	25 kW	470 to 890 MHz UHF	27 in x 27 in x 76.5 in (686 mm x 686 mm x 1943 mm)	245 lb (111.13 kg)
DA25 to 4U30	4 1/2 in IEC Unflanged	230 VAC				
DA40 to 5U15	4 7/8 in IEC Unflanged	115 VAC	40 kW	470 to 890 MHz UHF	27.5 in x 27.5 in x 84 in (701 mm x 701 mm x 2134 mm)	310 lb (140.6 kg)
DA40 to 5U30	4 7/8 in IEC Unflanged	230 VAC				
DA40F15	6 1/8 in IEC Flanged	115 VAC	40 kW	470 to 890 MHz UHF	27.5 in x 27.5 in x 84 in (701 mm x 701 mm x 2134 mm)	310 lb (140.6 kg)
DA40F30	6 1/8 in IEC Flanged	230 VAC				
DA40U30	6 1/8 in IEC Unflanged	230 VAC				

Note: Other models available, please consult factory.



## PRODUCT FEATURES

- Forced-air heat exchanger cooled load for high-power applications up to 900 MHz
- High power RF dissipation with 10, 25 and 50 kW versions are available
- Compact, low-profile design saves space in crowded transmitter sites
- Interlock control circuit provides fail-safe protection of the transmitter
- Available in models to work with 115 or 230 V at 50 or 60 Hz
- Optional Load Protection Switch available as a safeguard against costly damage and downtime

## Moduloads

### FORCED AIR-COOLED

Bird's Moduloads are self-cooling, low reflection, non-radiating terminations for higher power 50 Ohm RF transmission lines efficient at dissipation of RF over a wide frequency range. The equipment consists of three basic systems: the RF load assembly, the control system, and the heat exchanger system. Useable with CW, AM, FM, SSB, and TV modulation, and certain pulse types.

### LOAD SELECTION GUIDE

MODEL	INPUT POWER	POWER RATING & OPERATING TEMPERATURE	CONNECTOR	DIMENSIONS	WEIGHT
8631B115	9.5 A @ 115 V, 60 Hz	<b>10 kW -</b> 100% Water: 5 °C to 45 °C 35% Ethylene Glycol/65% Water: -20 °C to 35 °C	3 1/8 in EIA Flanged	24.6 in x 15.9 in x 17.5 in (623 mm x 402 mm x 443 mm)	113 lb (50.9 kg)
8631B230	4.75 A @ 230 V, 50 Hz		3 1/8 in EIA Flanged	24.6 in x 15.9 in x 17.5 in (623 mm x 402 mm x 443 mm)	113 lb (50.9 kg)
8635B115	9.5 A @ 115 V, 60 Hz		1 5/8 in EIA Flanged	24.6 in x 15.9 in x 17.5 in (623 mm x 402 mm x 443 mm)	113 lb (50.9 kg)
8635B230	4.75 A @ 230 V, 50 Hz		1 5/8 in EIA Flanged	24.6 in x 15.9 in x 17.5 in (623 mm x 402 mm x 443 mm)	113 lb (50.9 kg)
8645B115	11 A @ 115 V, 60 Hz	<b>25 kW -</b> 100% Water: 5 °C to 30 °C 35% Ethylene Glycol / 65% Water: -20 °C to 25 °C	3 1/8 in EIA Flanged	28.5 in x 19.6 in x 20.9 in (723 mm x 497 mm x 528 mm)	155 lb (70 kg)
8645B230	5.5 A @ 230 V, 50 Hz		3 1/8 in EIA Flanged	28.5 in x 19.6 in x 20.9 in (723 mm x 497 mm x 528 mm)	155 lb (70 kg)
8645B230-6	5.5 A @ 230 V, 60 Hz	<b>20 kW -</b> 100% Water: 5 °C to 45 °C 35% Ethylene Glycol / 65% Water: -20 °C to 35 °C	3 1/8 in EIA Flanged	28.5 in x 19.6 in x 20.9 in (723 mm x 497 mm x 528 mm)	155 lb (70 kg)
8655B115-6	15 A @ 115 V, 60 Hz		3 1/8 in EIA Flanged	53 in x 19.6 in x 20.9 in (1347 mm x 497 mm x 528 mm)	275 lb (125 kg)
8655B230-5	8 A @ 230 V, 50 Hz	<b>40kW -</b> 100% Water: 5 °C to 45 °C 35% Ethylene Glycol / 65% Water: -20 °C to 35 °C	3 1/8 in EIA Flanged	53 in x 19.6 in x 20.9 in (1347 mm x 497 mm x 528 mm)	275 lb (125 kg)
8655B230-6	8 A @ 230 V, 60 Hz		3 1/8 in EIA Flanged	53 in x 19.6 in x 20.9 in (1347 mm x 497 mm x 528 mm)	275 lb (125 kg)

### LOAD PROTECTION SWITCH GUIDE

MODEL	INPUT POWER	POWER RATING	CONNECTOR	DESCRIPTION
8640A930-1	24VDC (from included universal input power adapter)	60kW at 2MHz 20kW at 60MHz 16kW at 120MHz	3-1/8 in EIA Flanged	Provides an added layer of safety for the water-cooled Moduloads by preventing RF power from reaching it before proper coolant flow has been established, protecting it from damage that can result in costly downtime.

MADE IN  
USA

## RF Power Attenuators

### OIL CONVECTION-COOLED

The Bird oil convection-cooled attenuator 8320 Series may be used for the isolation of power sources up to their maximum power rating and for low level monitoring. They are valuable and reliable accessories for reducing power levels and VSWR, for isolating components under test, for harmonic signal analysis, and as comparison standards.

### ATTENUATOR SELECTION GUIDE

MODEL	POWER RATING	CONNECTOR	FREQ. RANGE & VSWR	COOLING METHOD	DIMENSIONS	WEIGHT
8325	500 W	QC - N(f) Input QC - N(f) Output	DC to 500 MHz at 1.10:1 max	Convection	17.5 in x 6.0 in x 8.5 in (445 mm x 151 mm x 216 mm)	25 lb (11.0 kg)
8327-300	1 kW	QC - LC(f) Input QC - N(f) Output	DC to 500 MHz at 1.10:1 max	Convection	24.0 in x 7.2 in x 17.2 in (596 mm x 181 mm x 437 mm)	57 lb (26.0 kg)
8329-300	2 kW	QC - LC(f) Input QC - N(f) Output	DC to 500 MHz at 1.10:1 max	Convection	24.0 in x 7.2 in x 17.2 in (596 mm x 181 mm x 437 mm)	57 lb (26.0 kg)
8329-300 w/ BA-300-115	4 kW	QC - LC(f) Input QC - N(f) Output	DC to 500 MHz at 1.10:1 max	Forced Convection, 115 VAC Fan	23.5 in x 7.2 in x 22.1 in (596 mm x 181 mm x 560 mm)	70.5 lb (32 kg)
8329-300 w/ BA-300-230	4 kW	QC - LC(f) Input QC - N(f) Output	DC to 500 MHz at 1.10:1 max	Forced Convection, 230 VAC Fan	23.5 in x 7.2 in x 22.1 in (596 mm x 181 mm x 560 mm)	70.5 lb (32 kg)

### BLOWER SELECTION GUIDE

MODEL	INPUT VOLTAGE	FUSE RATING	COMPATIBLE WITH MODELS
BA-300-115	115 VAC - 0.6A at 50-60 Hz	115 VAC - 1 A	889X-300 RF Termination 8329-300 RF Attenuators
BA-300-230	230 VAC - 0.3 A at 50/60 Hz	230 VAC - 500 mA	889X-300 RF Termination 8329-300 RF Attenuators
BA-310-115**	115 VAC - 0.6A at 50-60 Hz	115 VAC - 1 A	889X-300 RF Termination 8329-300 RF Attenuators
BA-310-230**	230 VAC - 0.3 A at 50/60 Hz	230 VAC - 500 mA	889X-300 RF Termination 8329-300 RF Attenuators

\*\*Selectable manual or standby mode, control thermostat included.

### PRODUCT FEATURES

- Self-contained instruments that require no external source of power
- Equipped with Quick-Change (QC) connectors
- Self cooling design
- Fully shielded against production of extraneous radiation
- Rugged construction

### SYSTEM

Coolant Method	Oil convection-cooled
Frequency Range/VSWR	DC to 500 MHz at 1.1:1 max
Impedance	50 Ohms
Standard Attenuation Value	30 dB
Operating Position	Horizontal

### ENVIRONMENTAL

Operating Temperature	-40 °C to 45 °C (-40 °F to 113 °F)
Humidity	95% non-condensing

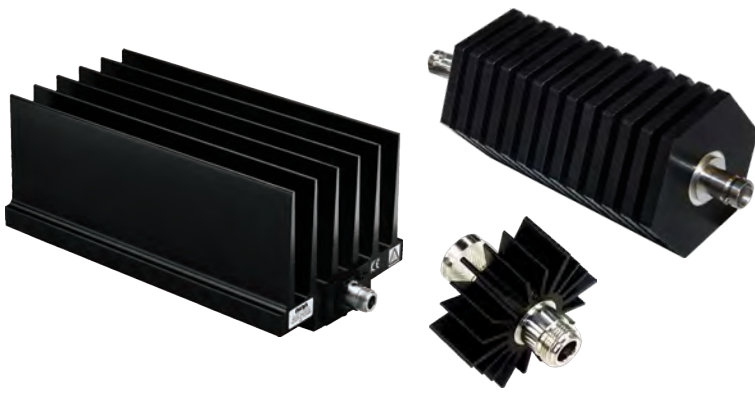

## RF Power Attenuators

### CONVECTION-COOLED

Bird's Convection-Cooled RF Power Attenuators are a valuable and reliable accessory for reducing power levels, for isolating components under test, for harmonic signal analysis and as comparison standards. They are world renowned for their high-quality, robust construction and conservative power ratings. These attenuators are fully shielded against production of extraneous radiation and the self-cooling design needs no cooling plate.

### PRODUCT FEATURES

- Self cooling design, needs no cooling plate
- Frequencies up to 18 GHz
- Attenuator requires no AC power
- Rugged construction, fully shielded
- Full broadband operation and models to cover all LTE frequencies

### SYSTEM

Coolant Method	Dry, convection-cooled
Impedance	50 Ohms
AC Power	None except 1.5 kW models require 115/230V AC power
PIM	-110 dBc min
Standard Attenuation Values	3, 6, 10, 20, 30 dB
Operating Position	Any

### ENVIRONMENTAL

Ambient Temperature	-40 °C to 40 °C (-40 °F to 104 °F)
Humidity	95% non-condensing

### ATTENUATOR CONFIGURATION GUIDE

POWER RATING	PRODUCT TYPE	CONNECTOR GENDER	CONNECTORS*	ATTENUATION VALUE
See selection guide	<b>A, SA, WA</b> = Attenuator	<b>M/F</b> = Male/Female <b>F/F</b> = Female/ Female	<b>A</b> = SMA <b>B</b> = BNC <b>N</b> = N <b>T</b> = TNC <b>E</b> = IEC 7/16	<b>03</b> = 3 dB <b>06</b> = 6 dB <b>10</b> = 10 dB <b>20</b> = 20 dB <b>30</b> = 30 dB

\*Call for custom connector options not shown in this catalog

**Example: 2-A-MFB-10**= Model 2-A, 2 W, A-Type Attenuator with Male/Female BNC connectors with an attenuation value of 10 dB.

Note: Not all combinations are valid. If assistance is needed consult the factory to define the model that is right for you.

### ATTENUATOR SELECTION GUIDE

MODEL	POWER RATING	CONNECTORS	FREQUENCY RANGE & VSWR	DIMENSIONS	WEIGHT	FINISH
2-A	2 W	BNC, N	DC to 1 GHz @ 1.10:1 max 1 to 4 GHz @ 1.25:1 max	2.4 in x 0.8 in dia (61 mm x 21 mm dia)	3.1 oz (88 g)	Tri-Alloy
2-A	2 W	SMA	DC to 2.5 GHz @ 1.15:1 max 2.5 to 6 GHz @ 1.30:1 max	0.9 in x 0.4 in dia (23 mm x 11 mm dia)	1.2 oz (34 g)	Stainless Steel
2-6A	2 W	N	DC to 6 GHz @ 1.25:1 max	1.8 in x 0.9 in dia (46 mm x 23 mm dia)	2.5 oz (71 g)	Stainless Steel
2-18A	2 W	SMA, N	DC to 4 GHz @ 1.15:1 max 4 to 12.4 GHz @ 1.25:1 max 12.4 to 18 GHz @ 1.35:1 max	1.8 in x 0.9 in dia (46 mm x 23 mm dia)	2.5 oz (71 g)	Stainless Steel
3-A	3 W	BNC, TNC	DC to 1 GHz @ 1.10:1 max 1 to 4 GHz @ 1.25:1 max	1.5 in x 0.6 in dia (39 mm x 16 mm dia)	3.1 oz (88 g)	Tri-Alloy
5-A	5 W	BNC, N, TNC	DC to 1 GHz @ 1.10:1 max 1 to 4 GHz @ 1.25:1 max	2.6 in x 0.8 in dia (67 mm x 21 mm dia)	3.1 oz (88 g)	Tri-Alloy

# RF Power Attenuators CONVECTION-COOLED

## ATTENUATOR SELECTION GUIDE

MODEL	POWER RATING	CONNECTORS	FREQUENCY RANGE & VSWR	DIMENSIONS	WEIGHT	FINISH
5-6A	5 W	N	DC to 6 GHz @ 1.25:1 max	2.4 in x 0.9 in dia (61 mm x 23 mm dia)	3.0 oz (86 g)	Stainless Steel
5-18A	5 W	SMA, N	DC to 4 GHz @ 1.15:1 max 4 to 12.4 GHz @ 1.25:1 max 12.4 to 18 GHz @ 1.35:1 max	2.5 in x 0.9 in dia (64 mm x 23 mm dia)	3.5 oz (100 g)	Stainless Steel
10-A	10 W	SMA, BNC, N	DC to 1 GHz @ 1.10:1 max 1 to 4 GHz @ 1.25:1 max	2.8 in x 2.3 in dia (72 mm x 59 mm dia)	5.0 oz (142 g)	Black Anodized Aluminum
10-6A	10 W	N	DC to 4 GHz @ 1.20:1 max 4 to 6 GHz @ 1.30:1 max	2.5 in x 1.1 in dia (64 mm x 28 mm dia)	3.5 oz (100 g)	Stainless Steel
10-18A	10 W	N	DC to 4 GHz @ 1.20:1 max 4 to 12.4 GHz @ 1.30:1 max 12.4 to 18 GHz @ 1.45:1 max	2.5 in x 0.9 in dia (64 mm x 23 mm dia)	3.5 oz (100 g)	Stainless Steel
25-A	25 W	SMA, BNC, N	DC to 1 GHz @ 1.10:1 max 1 to 4 GHz @ 1.25:1 max	5.3 in x 2.3 in dia (135 mm x 59 mm dia)	9.0 oz (256 g)	Black Anodized Aluminum
25-6A	25 W	N	1 to 6 GHz @ 1.20:1 max	4.2 in x 2.3 in x 2.3 in (107 mm x 59 mm x 59 mm)	13.5 oz (383 g)	Stainless Steel
25-18A	25 W	N	DC to 4 GHz @ 1.20:1 max 4 to 12.4 GHz @ 1.30:1 max 12.4 to 18 GHz @ 1.40:1 max	4.2 in x 2.3 in x 2.3 in (107 mm x 59 mm x 59 mm)	13.5 oz (383 g)	Stainless Steel
50-A	50 W	SMA, BNC, N	DC to 1 GHz @ 1.10:1 max 1 to 3 GHz @ 1.25:1 max	6.4 in x 2.3 in dia (163 mm x 59 mm dia)	1.0 lb (454 g)	Black Anodized Aluminum
50-6A	50 W	N	DC to 6 GHz @ 1.20:1 max	4.7 in x 3.0 in x 3.0 in (120 mm x 77 mm x 77 mm)	1.7 lb (772 g)	Stainless Steel
50-18A	50 W	N	DC to 6 GHz @ 1.25:1 max 6 to 12.4 GHz @ 1.35:1 max 12.4 to 18 GHz @ 1.45:1 max	4.7 in x 3.0 in x 3.0 in (120 mm x 77 mm x 77 mm)	1.7 lb (772 g)	Stainless Steel
75-A	75 W	BNC, N	DC to 1 GHz @ 1.10:1 max 1 to 3 GHz @ 1.25:1 max	7.3 in x 2.3 in dia (186 mm x 59 mm dia)	1.6 lb (726 g)	Black Anodized Aluminum
100-A	100 W	SMA, N	DC to 1 GHz @ 1.10:1 max 1 to 3 GHz @ 1.25:1 max	7.3 in x 2.6 in x 6.4 in (186 mm x 67 mm x 163 mm)	3.6 lb (1.6 kg)	Black Anodized Aluminum
100-6A	100 W	N	DC to 2 GHz @ 1.20:1 max 2 to 4 GHz @ 1.35:1 max 4 to 6 GHz @ 1.40:1 max	6.4 in x 2.7 in x 3.8 in (163 mm x 69 mm x 97 mm)	2.4 lb (1.7 kg)	Stainless Steel
100-SA	100 W	N	DC to 1 GHz @ 1.10:1 max 1 to 2.4 GHz @ 1.25:1 max	8.4 in x 2.8 in x 2.8 in (214 mm x 72 mm x 72 mm)	3.0 lb (1.4 kg)	Black Anodized Aluminum
150-A	150 W	BNC, N	DC to 1 GHz @ 1.10:1 max 1 to 3 GHz @ 1.25:1 max	6.7 in x 2.6 in x 11.9 in (171 mm x 67 mm x 303 mm)	6.6 lb (3.0 kg)	Black Anodized Aluminum
150-SA	150 W	BNC, N	DC to 1 GHz @ 1.10:1 max 1 to 2.4 GHz @ 1.25:1 max	9.1 in x 4.0 in x 5.0 in (232 mm x 102 mm x 127 mm)	5.5 lb (2.5 kg)	Black Anodized Aluminum
150-WA	150 W	BNC, N	DC to 1 GHz @ 1.10:1 max 1 to 2.4 GHz @ 1.25:1 max	5.6 in x 5.4 in x 4.3 in (143 mm x 138 mm x 110 mm)	2.5 lb (1.2 kg)	Black Anodized Aluminum
300-A	300 W	N	DC to 1 GHz @ 1.10:1 max 1 to 2.4 GHz @ 1.25:1 max	7.3 in x 5.4 in x 10.9 in (186 mm x 138 mm x 277 mm)	12.0 lb (5.5 kg)	Black Anodized Aluminum
300-WA	300 W	N	DC to 1 GHz @ 1.10:1 max 1 to 2.4 GHz @ 1.25:1 max	9.0 in x 5.4 in x 4.8 in (229 mm x 138 mm x 122 mm)	4.6 lb (2.1 kg)	Black Anodized Aluminum
500-WA	500 W	N	DC to 1 GHz @ 1.10:1 max 1 to 2.5 GHz @ 1.25:1 max	12.4 in x 5.4 in x 4.8 in (315 mm x 138 mm x 122 mm)	7.9 lb (3.6 kg)	Black Anodized Aluminum
600-A	600 W	N	DC to 1 GHz @ 1.10:1 max 1 to 2.4 GHz @ 1.25:1 max	12.7 in x 9.4 in x 9.6 in (323 mm x 239 mm x 244 mm)	21.5 lb (9.8 kg)	Black Anodized Aluminum
1000-A*	1 kW	N	DC to 1 GHz @ 1.10:1 max 1 to 2.4 GHz @ 1.25:1 max	13.6 in x 12.8 in x 9.6 in (346 mm x 326 mm x 244 mm)	26.5 lb (12.0 kg)	Black Anodized Aluminum
1000-WA*	1 kW	N	DC to 1 GHz @ 1.10:1 max 1 to 2.4 GHz @ 1.25:1 max	19.6 in x 10.6 in x 4.8 in (498 mm x 270 mm x 122 mm)	26.5 lb (12.0 kg)	Black Anodized Aluminum
1500-WA*	1.5 kW	N	DC to 1 GHz @ 1.10:1 max 1 to 2.4 GHz @ 1.25:1 max	20.4 in x 10.7 in x 5.9 in (519 mm x 272 mm x 150 mm)	30.0 lb (13.6 kg)	Black Anodized Aluminum

\*Attenuators 1 kW and above are not available in attenuation values less than 10 dB



# ACCESSORIES

## Precision RF Components and Accessories to Modify and Enhance Bird Products



**PASSIVE COMPONENTS**

Page 95 - 99



**VARIABLE RF SIGNAL SAMPLERS**

Page 100



**COAXIAL SELECTOR SWITCH**

Page 101



**QC SOLDERLESS RF  
CONNECTORS**

Page 102



**ADAPTERS, CONNECTORS  
& COUPLERS**

Page 103



**RF CONNECTOR &  
ADAPTER KITS**

Page 104 - 106



**PROTECTIVE CASES**

Page 107



**COAXIAL CABLES**

Page 108

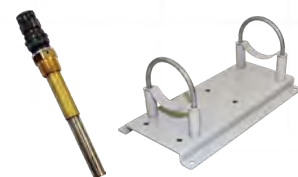

**LOAD & COOLING ACCESSORIES**

Page 109



## PRODUCT FEATURES

- Wide frequency band of 350 to 960 MHz
- Public safety coverage
- Low passive intermodulation
- Low VSWR & high gain
- Corrosion resistant, anti-aging
- Widely used for in-building applications

# Ceiling-Mount Omnidirectional Antenna

## ANT-350-960-NF

This compact, omnidirectional 350-960 MHz ceiling-mount antenna provides broad coverage. It is ideally suited for communications over the UHF, 700, 800 and 900 MHz public safety bands where wide coverage is desired.

Its near-invisible design makes this RF antenna ideal for use in office environments and public buildings where reliability, durability, and aesthetics are important.

### MEASUREMENT

<b>Frequency Range</b>	350 to 520 MHz 520 to 960 MHz
<b>Polarization</b>	Vertical
<b>Gain</b>	0.5 ±0.5 dB @ 350 to 520 MHz 1.5 ±0.5 dB @ 520 to 960 MHz
<b>Pattern Ripple</b>	±2 dB
<b>Vertical Beam Width</b>	100 ° @ 350 to 520 MHz 80 ° @ 520 to 960 MHz
<b>VSWR</b>	≤2.5
<b>Rated Wind Velocity</b>	≤2 m/s
<b>Total Input Power</b>	50 W
<b>Impedance</b>	50 Ohms
<b>Connector</b>	N(f)

### ENVIRONMENTAL

<b>Operating Temperature</b>	-40 °C to 55 °C (-40 °F to 130 °F)
------------------------------	---------------------------------------

### PHYSICAL

<b>Size</b>	Ø7.3x3.4 in (Ø185x85 mm)
<b>Weight</b>	.44 lb (0.20 kg)
<b>Color</b>	White
<b>Material</b>	ABS



## RF Couplers

### DC-450/2700-50 SERIES & PD-380/2700-200-3

For dependable support for the analysis and measurement of RF signals, Bird's RF Couplers offer a range of coupling factors, low insertion loss, and impressive accuracy.

	DC-450/2700-50 SERIES	PD-380/2700-200-3
<b>Item Type</b>	Directional Couplers	3dB Hybrid Coupler
<b>Frequency Range</b>	450 to 2700 MHz	380 to 2700 MHz
<b>Coupling</b>	DC-450/2700-50-4.8: 4.8 dB DC-450/2700-50-6: 6 dB DC-450/2700-50-7: 7 dB DC-450/2700-50-10: 10 dB DC-450/2700-50-15: 15 dB DC-450/2700-50-20: 20 dB	3.0 dB
<b>Accuracy</b>	DC-450/2700-50-4.8: $\pm 1.0$ dB DC-450/2700-50-6: $\pm 1.0$ dB DC-450/2700-50-7: $\pm 1.0$ dB DC-450/2700-50-10: $\pm 1.4$ dB DC-450/2700-50-15: $\pm 1.5$ dB DC-450/2700-50-20: $\pm 1.8$ dB	—
<b>Insertion Loss</b>	DC-450/2700-50-4.8: $\leq 2.1$ dB DC-450/2700-50-6: $\leq 1.75$ dB DC-450/2700-50-7: $\leq 1.45$ dB DC-450/2700-50-10: $\leq 0.80$ dB DC-450/2700-50-15: $\leq 0.60$ dB DC-450/2700-50-20: $\leq 0.40$ dB	$\leq 1.0$ dB
<b>Isolation</b>	DC-450/2700-50-4.8: $\geq 20$ dB DC-450/2700-50-6: $\geq 21$ dB DC-450/2700-50-7: $\geq 22$ dB DC-450/2700-50-10: $\geq 27$ dB DC-450/2700-50-15: $\geq 30$ dB DC-450/2700-50-20: $\geq 32$ dB	20 dB min
<b>VSWR</b>	$\leq 1.30$	$\leq 1.25$
<b>PIM Rating</b>	153 dBc @ 2*43 dBm	$\leq -153$ dBc @ 2 *43 dBm
<b>Power</b>	300 W avg	Average: 200 W avg RF Peak Power: 1.5 kW max
<b>Impedance</b>	50 Ohms	50 Ohms
<b>Connectors</b>	N(f)	N(f)
<b>Color</b>	Black	Black
<b>Temperature Range</b>	-35 °C to 65 °C (-31 °F to 149 °F)	-35 °C to 65 °C (-31 °F to 149 °F)
<b>Application</b>	IP65	Indoor & Outdoor, IP65



## Power Dividers

### PD-138/960-50 & PD-450/2700-300 SERIES

Bird's RF Power Dividers are world renowned for their high-quality, durable construction and conservative power ratings. Widely used for in-building applications, the line consists of power dividers in the frequency ranges of 138 to 960 MHz and 450 to 2700 MHz with low VSWR and low insertion loss characteristics.

	PD-138/960-50 SERIES	PD-450/2700-300 SERIES
<b>Item Type</b>	Power Dividers	Power Dividers
<b>Frequency Range</b>	138 to 960 MHz	450 to 2700 MHz
<b>Number of Input Ports</b>	1	1
<b>Number of Output Ports</b>	PD-138/960-50-2: 2 Ports PD-138/960-50-3: 3 Ports PD-138/960-50-4: 4 Ports	PD-450/2700-300-2: 2 Ports PD-450/2700-300-3: 3 Ports PD-450/2700-300-4: 4 Ports
<b>Splitter Loss</b>	PD-138/960-50-2: 3.0 dB PD-138/960-50-3: 4.8 dB PD-138/960-50-4: 6.0 dB	PD-450/2700-300-2: 3.0 dB PD-450/2700-300-3: 4.8 dB PD-450/2700-300-4: 6.0 dB
<b>Insertion Loss</b>	PD-138/960-50-2: 0.7 dB PD-138/960-50-3: $\leq 1.6$ dB PD-138/960-50-4: $\leq 1.8$ dB	PD-450/2700-300-2: $\leq 0.4$ dB PD-450/2700-300-3: $\leq 0.6$ dB PD-450/2700-300-4: $\leq 0.6$ dB
<b>Isolation</b>	PD-138/960-50-2: 20 dB min PD-138/960-50-3: 18 dB min PD-138/960-50-4: 16 dB min	—
<b>VSWR</b>	PD-138/960-50-2: $\leq 1.3:1$ PD-138/960-50-3: $\leq 1.3:1$ PD-138/960-50-4: $\leq 1.35:1$	PD-450/2700-300-2: $\leq 1.25$ PD-450/2700-300-3: $\leq 1.30$ PD-450/2700-300-4: $\leq 1.30$
<b>PIM Rating</b>	N/A	$\leq -153$ dBc @ 2*43 dBm
<b>Total Input Power</b>	50 W	300 W
<b>Impedance</b>	50 Ohms	50 Ohms
<b>Connectors</b>	N(f)	N(f)
<b>Color</b>	Black	Black
<b>Temperature Range</b>	-30 °C to 70 °C (-22 °F to 158 °F)	-35 °C to 75 °C (-31 °F to 167 °F)
<b>Application</b>	IP65	Indoor & Outdoor, IP65
<b>Dimensions</b>	PD-138/960-50-2: 6.5 in x 5.0 in x 1.0 in (158 mm x 122 mm x 24 mm) PD-138/960-50-3: 5.0 in x 6.5 in x 1.0 in (122 mm x 158 mm x 24 mm) PD-138/960-50-4: 5.0 in x 6.5 in x 1.0 in (122 mm x 158 mm x 24 mm)	—
<b>Weight</b>	PD-138/960-50-2: 1.8 lb (0.80 kg) PD-138/960-50-3: 1.9 lb (0.84 kg) PD-138/960-50-4: 2.0 lb (0.88 kg)	—



## Power Tappers

### TP-138/960-200 SERIES

Bird's RF Power Tappers are an economical and reliable alternative to directional couplers for in-building applications. Their high-quality and robust construction offer dependable bi-directional signal splitting over a broad frequency range.

	TP-138/960-200-3	TP-138/960-200-6	TP-138/960-200-10	TP-138/960-200-15	TP-138/960-200-20
<b>Frequency Range</b>	138 to 960 MHz	138 to 960 MHz	138 to 960 MHz	138 to 960 MHz	138 to 960 MHz
<b>Ratio</b>	2:1/3.0 dB nominal	4:1/6.0 dB nominal	10:1/10 dB nominal	30:1/15 dB nominal	100:1/20 dB nominal
<b>Output Split</b>	-1.8/-4.8 dB	-1.6/-7.0 dB	-0.9/-10.4 dB	-0.5/-15.3 dB	-0.4/-20.1 dB
<b>Branch Flatness</b> (Ref. to Input Level, includes Loss)					
@ 138 to 200 MHz	-7.8 dB ±0.7	-8.1 dB ±0.7	-11.0 dB ±0.8	-16.0 dB ±0.8	-20.3 dB ±1.0
@ 200 to 250 MHz	-6.8 dB ±0.6	-7.6 dB ±0.6	-10.7 dB ±0.7	-15.6 dB ±0.8	-20.1 dB ±1.0
@ 250 to 380 MHz	-6.0 dB ±0.6	-7.3 dB ±0.6	-10.3 dB ±0.7	-15.5 dB ±0.8	-20.0 dB ±1.0
@ 380 to 520 MHz	-5.5 dB ±0.6	-7.0 dB ±0.6	-10.1 dB ±0.7	-15.2 dB ±0.8	-20.1 dB ±1.0
@ 698 to 960 MHz	-4.8 dB ±0.5	-6.5 dB ±0.5	-9.9 dB ±0.5	-15.4 dB ±0.5	-21.1 dB ±1.0
<b>Input VSWR</b>					
@ 138 to 380 MHz max	1.4 dB	1.3 dB	1.20 dB	1.20 dB	1.20 dB
@ 380 to 960 MHz max	1.3 dB	1.25 dB	1.20 dB	1.20 dB	1.20 dB
<b>PIM Rating</b>	≤-153 dBc @2 *43 dBm	≤-153 dBc @2 *43 dBm	≤-153 dBc @2 *43 dBm	≤-153 dBc @2 *43 dBm	≤-153 dBc @2 *43 dBm
<b>Average Power</b>	200 W	200 W	200 W	200 W	200 W
<b>Impedance</b>	50 Ohms nominal	50 Ohms nominal	50 Ohms nominal	50 Ohms nominal	50 Ohms nominal
<b>Connectors</b>	N(f)	N(f)	N(f)	N(f)	N(f)
<b>Color</b>	Black	Black	Black	Black	Black
<b>Temperature Range</b>	-35 °C to 65 °C (-31 °F to 167 °F)	-35 °C to 65 °C (-31 °F to 167 °F)	-35 °C to 65 °C (-31 °F to 167 °F)	-35 °C to 65 °C (-31 °F to 167 °F)	-35 °C to 65 °C (-31 °F to 167 °F)
<b>Humidity</b>	5 to 95%	5 to 95%	5 to 95%	5 to 95%	5 to 95%
<b>Application</b>	IP65	IP65	IP65	IP65	IP65





## Divider/Combiners

### 2-AD-FFN-2 & 30-AD SERIES

Bird's Power Combiner/Dividers are world renowned for their high-quality, robust construction and conservative power ratings.

	2-AD-FFN-2	30-AD SERIES
<b>Divider/Combiner Type</b>	2-Way, 2 W	2-Way, 30 W
<b>Frequency Range</b>	2.0 to 2.5 GHz	800 to 2400 MHz
<b>Power Ratings</b>	2:1/3.0 dB nominal	30 W into 1.15:1 10 W into 1.50:1 1 W into Open
<b>Insertion Loss (above 3 dB split)</b>	<0.2 dB	<0.5 dB
<b>Isolation</b>	>20 dB min, J2 to J3	>20 dB min, J2 to J3
<b>VSWR</b>	1.17:1 max	1.25:1 max
<b>Matching</b>	<1.0 Degree Phase <0.2 dB Amplitude	<2 Degree Phase (typ. 0.5 deg) <0.5 dB Amplitude
<b>Connectors</b>	N(f), Hermetic Flange	N(f)
<b>Temperature Range</b>	Ambient Range: -10 to 70°C	—
<b>Environmental</b>	Weather-tight seal All mating connectors must have weather tight gaskets	—
<b>Housing</b>	Aluminum, Tri-Alloy	Aluminum
<b>Dimensions</b>	2.75 in x 2.75 in x 1.062 in (69.85 mm x 69.85 mm x 26.92 mm)	2.25 in x 2.50 in x 1.06 in (58 mm x 64 mm x 27 mm)



## Variable RF Signal Samplers

### 4273 & 4275 SERIES

Models 4273 and 4275 are wide range adjustable ThruLine® RF Couplers for signal observation on an oscilloscope, spectrum analyzer, or frequency counter. The output signal produced at the BNC output connector is an attenuated, unrectified signal. Both couplers have locking devices on their attenuation control.

### PRODUCT FEATURES

- Very low insertion VSWR across the operating frequency range with an insertion loss less than 0.2 dB
- Available with a wide variety of Quick Change (QC) connectors
- Passive device requiring no external source of power or utility service
- Includes locking devices on the attenuation control knob

### SYSTEM

<b>Impedance</b>	50 Ohms nominal
<b>Finish</b>	Bright silver plate

### ENVIRONMENTAL

<b>Ambient Temperature</b>	-40 °C to 45 °C (-40 °F to 113 °F)
----------------------------	------------------------------------

### PHYSICAL

<b>Size</b>	2.8 in x 2.875 in x 1.25 in (71 mm x 73 mm x 32 mm)
<b>Weight</b>	10 oz (280 g)

	4273	4273-020	4275	4275-020	4275-025
<b>Power Rating</b>	5 kW max	5 kW max	1 kW max	1 kW max	1 kW max
<b>Frequency Range</b>	1.5 to 35 MHz	1.5 to 35 MHz	20 to 1000 MHz	20 to 1000 MHz	20 to 1000 MHz
<b>Insertion Loss with N Connectors</b>	1.07 max	1.07 max	1.1 max 2 to 512 MHz 1.25 max 512 to 1000 MHz	1.1 max 2 to 512 MHz 1.25 max 512 to 1000 MHz	1.1 max 2 to 512 MHz 1.25 max 512 to 1000 MHz
<b>Coupling</b>	Adjustable as shown in chart within ±3 dB		N/A	N/A	N/A
<b>Connectors</b>	Not included, choose 2 Bird QC Type	QC Type (N) Male/Female	Not included, choose 2 Bird QC Type	QC Type (N) Male/Female	QC Type (N) Female/Female

4273 SERIES

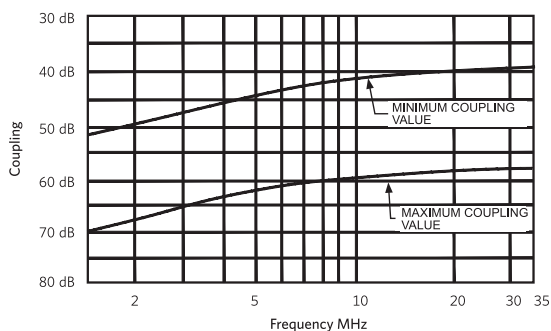

4275 SERIES

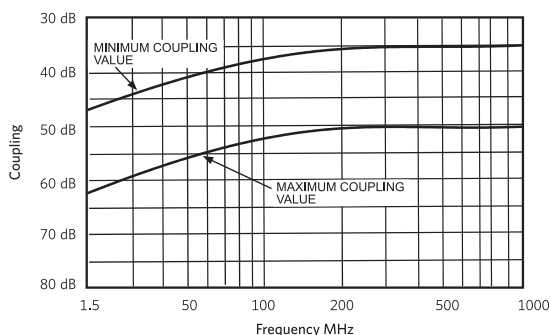



## PRODUCT FEATURES

- Designed for use in switching antenna, transmitters, receivers, and other gear using 50 Ohm coaxial impedance.
- Multiple models available with options for the required number of positions and circuits
- Prevents accidental operation
- May be panel-mounted
- Rugged design for field use

## Multi-Position, RF Selector Switches

### COAXSWITCH SERIES

Bird's® 50 Ohm Coaxial Selector Switches employ a unique, rugged and reliable design which permits positive contact, low insertion VSWR and negligible cross talk between channels. The switching mechanism is 4 1/2 in of RG-87/U Teflon cable which is pulled away from the mating Male N connectors and rotated to the desired switch position. The design is focused on precision and requires intentional sequential movement making accidental operation impossible.

### COAXSWITCH SELECTION GUIDE

MODEL	POSITIONS	COAXIAL CIRCUITS
7422	2	1
7441	3	1
7431	4	1
718	8	1
7181	10	1
72R	Reversing	2

#### MEASUREMENT

<b>Frequency Range</b>	DC to 10 GHz
<b>VSWR</b>	100 MHz: Negligible 1 GHz: 1.06 max 4 GHz: 1.30 max
<b>Insertion Loss</b>	100 MHz: 0.02 dB 1 GHz: 0.09 dB 4 GHz: 0.22 dB
<b>RF Power</b>	Max Rating @ 65°C 100 MHz: 850 W 1 GHz: 200 W 4 GHz: 75 W

#### SYSTEM

<b>RF Voltage</b>	500 V max
<b>Attenuation</b>	For unused channel - 75 dB (cross talk)

#### CONNECTORS

<b>Connector</b>	F(N)
------------------	------

#### ENVIRONMENTAL

<b>Operating Temperature</b>	-60 °C to 65 °C (-76 °F to 149 °F)
------------------------------	---------------------------------------

#### PHYSICAL

<b>Weight</b>	2.5 lb (1.1 kg)
---------------	-----------------

## Quick-Change Solderless RF Connectors **QC SERIES**

Many Termaline® load resistors, attenuators and absorption wattmeters, as well as ThruLine® wattmeters, employ our patented QC-type “Quick-Change Solderless” RF Connectors. These products may be ordered with the connector (s) most convenient for use with your equipment. Many customers order additional connectors to avoid using performance robbing adapters. QC Solderless Connectors are easily changed in the field by removing and replacing four screws.

Because of the wide variety of connectors and possible applications, electrical specifications for QC-equipped products are quoted with the standard connectors normally supplied with the equipment.

							
7/8 in EIA Swivel Flanged <b>4240-002</b>	LT(m) <b>4240-012</b>	LT(f) <b>4240-018</b>	LC(m) <b>4240-025</b>	LC(f) <b>4240-031</b>	UHF(f) S0239 <b>4240-050</b>	N(f) <b>4240-062</b>	N(m) <b>4240-063</b>
							
Open Term. #10-32 Nut <b>4240-080</b>	SC(f) <b>4240-090</b>	1 5/8 in EIA Fixed Flange(m) <b>4240-096</b>	C(f) <b>4240-100</b>	BNC(f) <b>4240-125</b>	BNC(m) <b>4240-132</b>	TNC(f) <b>4240-156</b>	TNC(m) <b>4240-160</b>
							
UHF(m) PL259 <b>4240-179</b>	1 5/8 in EIA Swivel(m) <b>4240-208</b>	HN(f) <b>4240-268</b>	HN(m) <b>4240-278</b>	SMA(m) <b>4240-334</b>	SMA(f) <b>4240-336</b>	7/16 DIN(f), IEC 169-4 <b>4240-344</b>	Mini UHF(f) <b>4240-346</b>
							
7/16 DIN(m), IEC 169-4 <b>4240-363</b>	SQS(m) <b>4240-370</b>	SQS(f) <b>4240-371</b>	SQS(m) Polarized <b>4240-372</b>	QDS-UL(f) <b>4240-373</b>	QDS-UL(m) <b>4240-374</b>	SQS(f) Polarized <b>4240-375</b>	QRM(f) <b>4240-376</b>
							
GQMJ(f) <b>4240-376-10</b>	GQL(f) <b>4240-376-20</b>	QRM(m) <b>4240-377</b>	QRM(f) Polarized <b>4240-377-2</b>	QRM(m) Polarized <b>4240-378</b>			

## Adapters, Connectors & Couplers

Bird® manufactures a variety of Adapter Accessories for your application needs.

### INTERSERIES RF ADAPTERS



N(m)  
4240-402



N(f)  
4240-403



BNC(m)  
4240-404



BNC(f)  
4240-405



TNC(m)  
4240-406



TNC(f)  
4240-407



UHF(m)  
4240-408



UHF(f)  
4240-409



SMA(m)  
4240-410



SMA(f)  
4240-411

### QC SERIES, RF ADAPTERS



QC(f) to QC(f)  
4240-165



3 1/8 in Flanged  
to QC(f)  
4240-194



1 5/8 in Flanged  
to QC(f)  
4240-260

### FLANGE-TO-FLANGE RF ADAPTERS



3 1/8 in Flanged to 1 5/8 in EIA  
Flanged 50 Ohm  
4600-025



1 5/8 in Flanged to 7/8 in EIA  
Flanged 50 Ohm  
4712-015

### RF COUPLING KITS



7/8 in Flanged  
4240-220



3 1/8 in Flanged  
4600-020



1 5/8 in Flanged  
4712-020



6 1/8 in Flanged  
4902-020



## RF Connector/Adapter Kit

### MODEL 4240-400

Assemble compact, precision 50 Ohm adapters to meet up to 45 different matching requirements. The adapters offer low VSWR because of precision matching and tight mating tolerances. The kit lets you create 30 combinations and includes enough couplers to assemble 5 complete adapters at the same time.



#### KIT INCLUDES



(2) N(m)  
4240-402



(2) N(f)  
4240-403



(1) BNC(m)  
4240-404



(1) BNC(f)  
4240-405



(1) TNC(m)  
4240-406



(1) TNC(f)  
4240-407



(1) UHF(m)  
4240-408



(1) UHF(f)  
4240-409



(5) 50 Ohm  
Couplers  
4240-413

## RF Interseries Adapter Kit with SMA

### MODEL 4240-401

The 4240-401 RF Adapter Kit lets you assemble compact, precision 50 Ohm adapters to meet up to 45 different matching requirements. The adapters offer low VSWR because of precision matching and tight mating tolerances. Adapters and couplers are perfectly fitted in a hard carrying case.



#### KIT INCLUDES



(1) N(m)  
4240-402



(1) N(f)  
4240-403



(1) BNC(m)  
4240-404



(1) BNC(f)  
4240-405



(1) TNC(m)  
4240-406



(1) TNC(f)  
4240-407



(1) UHF(m)  
4240-408



(1) UHF(f)  
4240-409



(1) SMA(m)  
4240-410



(1) SMA(f)  
4240-411



(5) 50 Ohm  
Couplers  
4240-413

## Aviation RF Connector/Adapter Kit

### MODEL 4240-401AV

The 4240-401AV RF Adapter Kit is designed specifically for the aviation industry and allows you to assemble compact, precision 50 Ohm adapters to meet up to 45 different matching requirements. The adapters offer low VSWR because of precision matching and tight mating tolerances. Adapters and couplers are perfectly fitted in a hard carrying case.



#### KIT INCLUDES



(1) N(m)  
4240-402



(1) N(f)  
4240-403



(1) BNC(m)  
4240-404



(1) BNC(f)  
4240-405



(1) TNC(m)  
4240-406



(1) TNC(f)  
4240-407



(1) SMA(m)  
4240-410



(1) SMA(f)  
4240-411



(5) 50 Ohm  
Couplers  
4240-413



(1) C(f)  
4240-418



(1) C(m)  
4240-419

## 7/16 DIN Precision RF Adapter Kit

### MODEL 4240-550

The 4240-550 RF Adapter Kit is a general purpose kit for any 7/16 DIN adapter application. Recommended use with Cable & Antenna Analyzers and features low passive intermodulation and low VSWR. Adapters are perfectly fitted in a hard carrying case.



#### KIT INCLUDES



(1) N(m) to  
7/16 DIN(m)  
PA-MNME



(1) N(m) to  
7/16 DIN(f)  
PA-FNFE



(1) N(f) to 7/16  
DIN(m)  
PA-FNME



(1) N(f) to 7/16  
DIN(f)  
PA-MNFE



(1) 7/16 DIN(f)  
to Right Angle  
7/16 DIN(m)  
PA-FEME-R



(1) 7/16 DIN(f)  
to 7/16 DIN(f)  
PA-FEFE

## 4.3/10, Interseries RF Adapter Kit

### MODEL 4240-560

Assemble compact, precision 50 Ohm adapters to meet up to 45 different matching requirements. The adapters offer low VSWR because of precision matching and tight mating tolerances.

#### KIT INCLUDES



(1) 4.3-10(f) to  
4.3-10(f)  
**PA-F4.3F4.3**



(1) 4.3-10(f) to  
4.3-10(m) RA  
**PA-F4.3M4.3-R**



(1) N(m) to  
4.3-10(f)  
**PA-MNF4.3**



(1) N(f) to 4.3-  
10(m)  
**PA-FNM4.3**



(1) N(f) to 4.3-  
10(f)  
**PA-FNF4.3**



(1) N(m) to  
4.3-10(m)  
**PA-MNM4.3**





## Protective Cases

Protect and easily transport your equipment with this sturdy carrying cases from Bird®. Most carrying cases include shock-absorbing laminated die-cut foam inserts, durable polyurethane shell, folding handle and quick release latches to keep everything secure.



RF Wattmeter Hard Carrying Case, 5 Elements and 1 Small RF Load  
**CC-6**



Plug-In Element Hard Carrying Case, 12 Elements  
**EC-1**



RF Wattmeter Hard Carrying Case, RF Load, Signal Sampler, QC Connectors and 4 Elements  
**4300-061**



4391A RF Power Analyst Hard Carrying Case, RF Signal Sampler and Accessories  
**4300A085**



4410A RF Wattmeter Hard Carrying Case, RF Load, 4 Elements and Accessories  
**4300A055**



4421A RF Wattmeter Hard Carrying Case, 4 RF Power Sensors and Accessories  
**4300B215**



RF Digital Power Meter and Antenna Tester Hard Carrying Case  
**5000-035**



FlightHawk™ Hard Carrying Case  
**FH-AV-CC**



5000-NG Premium Carrying Case  
**5B5000-1**

## RF Coaxial Cables **DC SERIES**

Bird® provides a wide selection of cable assemblies to suit any RF application. For use with Bird's Wattmeters and Watcher Series Monitors.



14 in DC to BNC(m)  
Group I  
**3170-058-1**



6 ft DC to BNC(m)  
Group I  
**3170-058-6**



25 ft DC to BNC(m)  
Group I  
**3170-058-3**



50 ft DC to BNC(m)  
Group I  
**3170-058-5**



12 in DC to Snap Spade  
Group II  
**4220-097-1**



10 ft DC to Snap Spade  
Group II  
**4220-097-7**



25 ft DC to Snap Spade  
Group II  
**4220-097-10**



50 ft DC to Snap Spade  
Group II  
**4220-097-17**



75 ft DC to Snap Spade  
Group II  
**4220-097-13**



100 ft DC to Snap Spade  
Group II  
**4220-097-16**



39.5 in DC to DC Connector  
Group III  
**7500-072-1**



10 ft DC to DC Connector  
Group III  
**7500-072-4**



## Load & Cooling Accessories

Bird® manufactures a variety of RF Termination Accessories for your Bird® Products.



### THERMOSWITCHES FOR AIR-COOLED LOADS

PART#	FUNCTION	TEMP. SET POINT	USE WITH
8890-008	Over Temp. Interlock	Opens at 236 °C	8890 and 8920 Series
8890-017	Over Temp. Interlock	Opens at 226 °C	8930 Series
8329-028	Over Temp. Interlock	Opens at 200 °C	8929 Series



### WATER-COOLED LOAD ACCESSORIES

PART#	DESCRIPTION	USE WITH
RPK6770A120	RF Termination Wall Mount Bracket	8730A Econoload Series (10 kW)
RPK5-898-6	4 GPM Water Flow Switch	10 kW Econoload Series
RPK5-898-2	6 GPM Water Flow Switch	20 kW Econoload Series
RPK5-898-3	7 GPM Water Flow Switch	30 kW Econoload Series



### LIQUID COOLANTS\*

PART#	DESCRIPTION	VOLUME/PKG.
5-030-3	Refined Mineral Oil	1 Gallon (3.79 L)
5-1070-2	PMX-200, Silicone Oil	1 Gallon (3.79 L)
5-1070-3	PMX-200, Silicone Oil	5 Gallon (18.93 L)
5-1134-3	Ethylene Glycol, Industrial Grade	1 Gallon (3.79 L)

\*Includes SDS sheet with shipment

### REPLACEMENT RESISTORS

PART#	USE WITH
8731-031-1	8731 Econoload Series (10 kW)
RPK8738A072	8730A/8738A Econoload Series (10 kW)
RPK8755-027-2	8745/8746 Econoload Series (20 kW)
RPK8755-027-3	8755/8756 Econoload Series (30 kW)
RPK8755-027-4	8765/8766 Econoload Series (40 kW)
RPK8755-027-5	8775/8776 Econoload Series (50 kW)
RPK8792-010-1	8792 Econoload Series (80 kW)
RPK5A2388	8578A100 Forced-Air Load (10 kW)

### DOLLIES

PART#	DESCRIPTION
6771-011	For 10 and 25 kW Moduload
6772B011	For 50 kW Moduload
6773-011	For 892X, 893X Oil Loads



# SOFTWARE

## Enhance the Management and Performance of Bird RF Sensor and Monitor Products

Bird has developed intuitive and flexible software applications that provide set up and monitoring of a wide range of Bird RF sensor and monitor products. The Bird RF Meter App is ideal for field use, turning an Android phone into a power meter capable of connecting with and monitoring Bird USB Field Sensors. The VPM3, Virtual Power Meter Software is a true Windows application allowing for simultaneous management and logging of multiple sensors from the desktop.



**BIRD RF METER APP**

[Page 111](#)



**VPM3**

[Page 111](#)

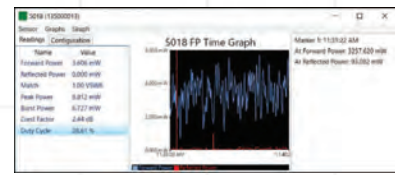

**WINDOWS® 10 RF METER APP**

[Page 112](#)



## Bird RF Meter App

### RF METER APP FOR BIRD USB FIELD POWER SENSORS

Ideally suited for field techs and engineers who need to make power measurements anywhere they go. The RF Meter's mobile interface has an intuitive, menu-driven design making it easy to use. Utilizing an Android phone and downloading the RF Meter App from the Google Play store, you can pair and set up a Bird sensor with the appropriate configurations, correction factors, offsets and zero calibration. The app also includes the ability to enable smoothing level for more stable readings or max hold to detect the maximum measured power.

The RF Meter App is available for download from the Bird website for a PC running Windows 10.

### PRODUCT FEATURES

- Automatically detects sensor and opens the application
- Identifies multiple sensors and saves session information
- Displays only the information appropriate to sensor indicated
- Digital Display function, bar and time graphing and logging capabilities
- Share results directly to messaging, email or WiFi printer.
- Plug and Play in Seconds
- Displayable Parameters (sensor dependent): True Average Power (Forward and Reflected), VSWR, Return Loss, rho, Match Efficiency, Peak Power, Peak to Average Ratio, Crest Factor, PEP, CDF, CCDF, Confidence %, Burst and Burst Average Power, IEEE 194 Pulse Parameters, Sensor temperature.

### COMPATIBLE DEVICES

- Power Sensors: 5012D, 5014, 5016D, 5017D, 5017D-AV, 5018D, 5019D, 7020 Series, 7022 Series
- Power Monitors: 4042, 4043, 4044, 3141 Channel Power Monitor, BPME Series

### SYSTEM REQUIREMENTS

- Android version 4.0.3 or higher
- Hardware must support On-The-Go (OTG) host functionality
- Available through Google Play



## Virtual RF Power Meter Software

### VPM3

The VPM3, Virtual Power Meter is a Microsoft Windows® RF power measurement application with advanced functionality. Compatible with a full range of Bird RF Power Sensors, the program integrates data logging in XML or CSV formats and the ability to manage multiple sensors simultaneously.

### PRODUCT FEATURES

- Manage up to 50 sensors simultaneously
- Multiple display functions: digital, analog and strip chart
- Each display screen can be customized for user preference
- Functions: True Average Power (Forward and Reflected), VSWR, Peak Power, Crest Factor, CCDF, Burst Power
- True Windows application
- Data logging capability with playback of saved log files
- Snapshot capabilities
- Ideal for use as a system component
- No calibration required
- Plug-and-play in seconds

### COMPATIBLE DEVICES

- Power Sensors: 5012D, 5014, 5016D, 5017D, 5017D-AV, 5018D, 5019D, 7020, 7022

### SYSTEM REQUIREMENTS

- Windows 7 SP1
- Internet Explorer or equivalent
- Adobe Reader
- 1280 x 720, 16 bit or higher resolution recommended
- 100 MB free disk space
- 1 available USB port
- Mouse or pointing device

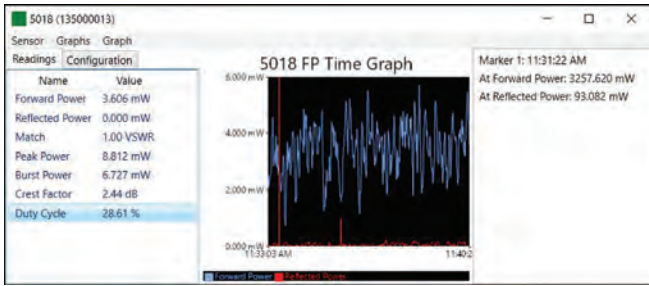

## Bird RF Meter - Windows®10

### RF METER APP FOR USE WITH WINDOWS®10

Ideally suited for field techs and engineers who need to make power measurements utilizing a PC or laptop running Microsoft Windows®10. Installation is fast and easy requiring only a connection of the power sensor to the windows PC with RF Meter App Installed.

The RF Meter App is available for download from the Bird website for a PC running Windows 10.

### PRODUCT FEATURES

- 100% compatible with all USB power sensors & Windows 10
- Functions: True Average Power (Forward and Reflected), VSWR, Peak Power, Crest Factor, CCDF, Burst Power (sensor dependent)
- True Windows Application
- Offset, smoothing & scaling
- Data logging capability
- Time & Bar graphing display & markers
- Snapshot & sharing capabilities
- No calibration require
- Plug to Play in seconds

### COMPATIBLE DEVICES

- Power Sensors: 5012D, 5014, 5015, 5015-EF, 5016D, 5017D, 5018D, 5019D, 7020, 7022

### SYSTEM REQUIREMENTS

- Windows 10
- Adobe Reader
- 1280 x 720, 16 bit or higher resolution recommended
- 100 MB free disk space
- 1 available USB port
- Mouse or pointing device

# Index

1J-950 .....	71	25A.....	70	100-CT .....	81
1J-1100.....	71	25B.....	70	100D.....	70
2.5J-950.....	71	25C.....	70	100E-400.....	70
2.5J-1100 .....	71	25-CT.....	81	100E-800.....	70
2-6A.....	92	25D.....	70	100H.....	70
2-18A.....	92	25E-400 .....	70	100J-950 .....	71
2-18T.....	82	25E-800 .....	70	100J-1100.....	71
2-A.....	92	25H.....	70	100KH3.....	75
2-AD-FFN-2.....	99	25J-950.....	71	100-NST.....	83
2-NT.....	82	25J-1100 .....	71	100-SA.....	93
2-T.....	82	25KB1.....	74	100-ST.....	83
3-A.....	92	25KB3.....	75	100-T.....	83
4.3/10, Interseries RF Adapter Kit .....	106	25KC3.....	75	110-1.....	70
5-6A.....	93	25KH3.....	75	150-1.....	70
5-18A.....	93	25KH12.....	74	150-2.....	70
5-18T.....	82	25-T.....	83	150-A.....	93
5-030-3.....	109	030-2.....	70	150-SA.....	93
5-1070-2.....	109	30-AD Series.....	99	150-ST.....	83
5-1070-3.....	109	040-1.....	70	150-T.....	83
5-1134-3.....	109	040-2.....	70	150-WA.....	93
5-1375.....	62	43.....	61	150-WT.....	83
5-A.....	92	43P.....	61	151-CT.....	81
5A.....	70	050-1.....	70	200-1.....	70
5B.....	70	050-2.....	70	200-2.....	70
5B5000-1.....	107	50-6A.....	93	250-2.....	70
5C.....	70	50-6T.....	83	250A.....	70
5D.....	70	50-18A.....	93	250B.....	70
5E-400.....	70	50-18T.....	83	250B1.....	74
5E-800.....	70	50-A.....	93	250B3.....	75
5J-950.....	71	50A.....	70	250B12.....	74
5J-1100.....	71	50B.....	70	250C.....	70
5-NT.....	82	50C.....	70	250C3.....	75
5-T.....	82	50-CT.....	81	250-CT.....	81
7/16 DIN Precision RF Adapter Kit .....	105	50D.....	70	250D.....	70
10-6A.....	93	50E-400 .....	70	250E-400.....	70
10-18A.....	93	50E-800 .....	70	250E-800.....	70
10-A.....	93	50H.....	70	250H.....	70
10A.....	70	50J-950.....	71	250J-950 .....	71
10B.....	70	50J-1100 .....	71	250J-1100.....	71
10C.....	70	50KB3.....	75	275-1.....	70
10D.....	70	50KH1.....	74	300-A.....	93
10E-400.....	70	50KH3.....	75	300B1.....	74
10E-800.....	70	50-NT.....	83	300-CT.....	81
10J-950.....	71	50-T.....	83	300-T.....	83
10J-1100 .....	71	060-1.....	70	300-WA.....	93
10KB1.....	74	060-2.....	70	300-WT.....	83
10KB3.....	75	72R.....	101	400-2.....	70
10KB12.....	74	75-A.....	93	400-50.....	73
10KC3.....	75	75-T.....	83	400-75.....	73
10KH1.....	74	080-1.....	70	400-125.....	73
10KH3.....	75	080-2.....	70	400-225.....	73
10KH12.....	74	095-1.....	70	400-400.....	73
10-T.....	83	095-2.....	70	400-750.....	73
15KB1.....	74	100-6A.....	93	425-1.....	70
15KB3.....	75	100-6T.....	83	430-2.....	72
15KH1.....	74	100-A.....	93	430-3.....	72
025-2.....	70	100A.....	70	430-7.....	72
25-6A.....	93	100B.....	70	430-8.....	72
25-6T.....	83	100B1.....	74	430-13.....	72
25-18A.....	93	100B3.....	75	430-16.....	72
25-18T.....	83	100B12.....	74	430-20.....	72
25-A.....	93	100C.....	70	430-22.....	72



430-27.....	72	100,0C.....	70	4027A800K.....	26
430-28.....	72	1000C3.....	75	4027A Series.....	26
430-33.....	72	1000D.....	70	4027F2M.....	27
430-48.....	72	1000E-400.....	70	4027F10M.....	27
430-57.....	72	1000E-800.....	70	4027F60M.....	27
430-61.....	72	1000H.....	70	4027F Series.....	27
430-65.....	72	1000H1.....	74	4028A2M.....	28
430-86.....	72	1000H12.....	74	4028A3M.....	28
430-157.....	72	1000J-950.....	71	4028A4M.....	28
430-205.....	72	1000J-1100.....	71	4028A10M.....	28
430-208.....	72	1000P.....	71	4028A25M.....	28
430-217.....	72	1000-T.....	83	4028A250K.....	28
430-247.....	72	1000-WA.....	93	4028A400K.....	28
430-248.....	72	1000-WT.....	83	4028B3M.....	28
430-249.....	72	1500B1.....	74	4028B10M.....	28
430-253.....	72	1500B3.....	75	4028C10M.....	28
430-254.....	72	1500H1.....	74	4028 Series.....	28
430-255.....	72	1500-W.....	83	4042E Series.....	52, 53
430-256.....	72	1500-WA.....	83, 93	4042 Series.....	52
430-258.....	72	2500A.....	70, 72	4043E Series.....	52, 53
430-263.....	72	2500B.....	70, 72	4043 Series.....	52
430-264.....	72	2500B1.....	74	4044 Series.....	52
430-265.....	72	2500B3.....	75	4210A100.....	69
500A.....	70	2500B12.....	74	4220-097-1.....	108
500B.....	70	2500C.....	70, 72	4220-097-7.....	108
500B1.....	74	2500C3.....	75	4220-097-10.....	108
500B3.....	75	2500D.....	70	4220-097-13.....	108
500B12.....	74	2500E-400.....	70, 72	4220-097-16.....	108
500C.....	70	2500E-800.....	70, 72	4220-097-17.....	108
500-CT.....	81	2500H.....	70	4230-006-1.....	68
500D.....	70	2500H1.....	74	4230-018.....	68
500E-400.....	70	2500H3.....	75	4230-057.....	68
500E-800.....	70	2500H12.....	74	4230-059.....	68
500H.....	70	2500J-950.....	71	4240-002.....	102
500H12.....	74	2500J-1100.....	71	4240-012.....	102
500J-950.....	71	2500P.....	71	4240-018.....	102
500J-1100.....	71	3000B1.....	74	4240-025.....	102
500-WA.....	93	3000H1.....	74	4240-031.....	102
500-WT.....	83	3127-040.....	66	4240-050.....	102
501-50.....	73	3127-075.....	66	4240-062.....	102
501-75.....	73	3127A Series.....	56	4240-063.....	102
501-125.....	73	3127 Series.....	66	4240-080.....	102
501-225.....	73	3128A Series.....	56	4240-090.....	102
501-400.....	73	3129A.....	55	4240-096.....	102
553-50.....	73	3141A15.....	51	4240-100.....	102
553-75.....	73	3141A48.....	51	4240-125.....	102
553-125.....	73	3141 Series.....	51	4240-132.....	102
553-401.....	73	3170-058-1.....	108	4240-156.....	102
600-A.....	93	3170-058-3.....	108	4240-160.....	102
600B1.....	74	3170-058-5.....	108	4240-165.....	103
600-T.....	83	3170-058-6.....	108	4240-179.....	102
606-50.....	73	4020 Series.....	29	4240-194.....	103
606-400.....	73	4021.....	29	4240-208.....	102
718.....	101	4022.....	29	4240-220.....	103
801-1.....	70	4023A3G.....	29	4240-260.....	103
801-2.....	70	4024.....	29	4240-268.....	102
1000-A.....	93	4025.....	29	4240-278.....	102
1000A.....	70	4027A2M.....	26	4240-334.....	102
1000B.....	70	4027A4M.....	26	4240-336.....	102
1000B1.....	74	4027A12M.....	26	4240-344.....	102
1000B3.....	75	4027A250K.....	26	4240-346.....	102
1000B12.....	74	4027A400K.....	26	4240-363.....	102

4240-370.....	102	4802-000.....	68	8251D7-16.....	86
4240-371.....	102	4902-020.....	103	8325.....	91
4240-372.....	102	4905-000.....	68	8327-300.....	91
4240-373.....	102	5000-035.....	107	8329-028.....	109
4240-374.....	102	5000A.....	70, 72	8329-300.....	91
4240-375.....	102	5000B.....	70, 72	8329-300 w/ BA-300-115.....	91
4240-376.....	102	5000B1.....	74	8329-300 w/ BA-300-230.....	91
4240-376-10.....	102	5000B3.....	75	8401.....	84
4240-376-20.....	102	5000B12.....	74	8631B115.....	90
4240-377.....	102	5000C.....	70, 72	8631B230.....	90
4240-377-2.....	102	5000C3.....	75	8635B115.....	90
4240-378.....	102	5000D.....	70	8635B230.....	90
4240-400.....	104	5000E-400.....	70, 72	8645B115.....	90
4240-401.....	104	5000E-800.....	70, 72	8645B230.....	90
4240-401AV.....	105	5000H.....	70	8645B230-6.....	90
4240-402.....	103	5000H1.....	74	8655B115-6.....	90
4240-403.....	103	5000H3.....	75	8655B230-5.....	90
4240-404.....	103	5000H12.....	74	8655B230-6.....	90
4240-405.....	103	5000J-950.....	71	8720.....	87
4240-406.....	103	5000J-1100.....	71	8726.....	87
4240-407.....	103	5000-NG.....	41	8730A.....	87
4240-408.....	103	5000P.....	71	8731.....	87
4240-409.....	103	5012D.....	42	8731-031-1.....	109
4240-410.....	103	5014.....	46	8738A.....	87
4240-411.....	103	5016D.....	42	8745.....	87
4240-550.....	105	5017D.....	42	8746.....	87
4240-560.....	106	5017D-AV.....	42	8755.....	87
4273.....	100	5018D.....	42	8756.....	87
4273-020.....	100	5019D.....	42	8765.....	87
4273 Series.....	100	6000B1.....	74	8775.....	87
4274-025.....	72	6000H1.....	74	8776.....	87
4274-050.....	72	6771-011.....	109	8792.....	87
4275.....	100	6772B011.....	109	8860.....	84
4275-020.....	100	6810-220.....	65	8861.....	84
4275-025.....	100	6810-230.....	65	8862.....	84
4275 Series.....	100	6810-309-7.....	65	8865SC13.....	86
4300-061.....	107	6810 Series.....	65	8890-008.....	109
4300A055.....	107	7001A500-1-2.....	31	8890-017.....	109
4300A085.....	107	7001A500-1-xyyy.....	31	8890-300.....	85
4300B215.....	107	7001A550-2.....	31	8890-300SC13.....	86
4304A.....	61	7001A900-2.....	31	8890-315.....	85
4314C.....	61	7001A900-3.....	31	8890-320.....	85
4391A.....	61, 64	7001B040-5M.....	31	8891-300.....	85
4410A.....	61, 62	7003A001.....	17	8891-315.....	85
4421A-10-00-0.....	23	7020-1-010101.....	44	8891-320.....	85
4421A-10-11-0.....	23	7020-1-020101.....	44	8891D300.....	86
4421A-20-00-0.....	23	7020-1-030301.....	44	8892-300.....	85
4421A-20-11-0.....	23	7020 Series.....	44	8892-315.....	85
4431.....	61	7022-1-020201.....	45	8892-320.....	85
4522A002-5.....	68	7027 Series.....	25	8892-333.....	109
4526.....	67	7037 Series.....	24	8892D300.....	86
4527.....	67	7181.....	101	8892D320.....	86
4600-020.....	103	7422.....	101	8895-300.....	85
4600-025.....	103	7431.....	101	8895-315.....	85
4610-000.....	68	7441.....	101	8895-320.....	85
4642-010.....	68	7500-072-1.....	108	8921.....	85
4712-015.....	103	7500-072-4.....	108	8921SC13.....	86
4712-020.....	103	8135.....	84	8922.....	85
4715-000.....	68	8141.....	84	8922D.....	86
4723-000.....	68	8201.....	84	8926.....	85
4723-020.....	68	8251.....	84	8926D.....	86
4801-100.....	68	8251D.....	86	8927D.....	86

8927D ..... 86  
 8931-115 ..... 85  
 8931-115SC13 ..... 86  
 8931-230 ..... 85  
 8931-230SC13 ..... 86  
 8932-115 ..... 85  
 8932-230 ..... 85  
 8936-115 ..... 85  
 8936-230 ..... 85  
 8936D115 ..... 86  
 8936D230 ..... 86  
 8941-115SC13 ..... 86  
 8941-230SC13 ..... 86  
 10000B ..... 72  
 10000E-400 ..... 72  
 10000E-800 ..... 72  
 10000H ..... 72  
 10000P ..... 71

**A**

Accessories ..... 94  
 Adapters, Connectors & Couplers ..... 103  
 ANT-350-960-NF ..... 95  
 APM-1B ..... 47, 63  
 APM-1C ..... 47, 63  
 APM-1E-400 ..... 47, 63  
 APM-1E-800 ..... 47, 63  
 APM-2.5B ..... 47, 63  
 APM-2.5D ..... 47, 63  
 APM-2.5E-400 ..... 47, 63  
 APM-2.5E-800 ..... 47, 63  
 APM-5A ..... 47, 63  
 APM-5B ..... 47, 63  
 APM-5C ..... 47, 63  
 APM-5D ..... 47, 63  
 APM-5E-400 ..... 47, 63  
 APM-5E-800 ..... 47, 63  
 APM-5H ..... 47, 63  
 APM-10A ..... 47, 63  
 APM-10B ..... 47, 63  
 APM-10C ..... 47, 63  
 APM-10D ..... 47, 63  
 APM-10E-400 ..... 47, 63  
 APM-10E-800 ..... 47, 63  
 APM-16 ..... 60, 61, 63  
 APM-25B ..... 47, 63  
 APM-25C ..... 47, 63  
 APM-25D ..... 47, 63  
 APM-25E-400 ..... 47, 63  
 APM-25E-800 ..... 47, 63  
 APM-50C ..... 47, 63  
 APM-50D ..... 47, 63  
 APM-50E-400 ..... 47, 63  
 APM-50E-800 ..... 47, 63  
 APM-100A ..... 47, 63  
 APM-100B ..... 47, 63  
 APM-100C ..... 47, 63  
 APM-100D ..... 47, 63  
 APM-100E-400 ..... 47, 63  
 APM-100E-800 ..... 47, 63  
 APM-100H ..... 47, 63

APM-250A ..... 47, 63  
 APM-250B ..... 47, 63  
 APM-250C ..... 47, 63  
 APM-250D ..... 47, 63  
 APM-250E-400 ..... 47, 63  
 APM-250E-800 ..... 47, 63  
 APM-250H ..... 47, 63  
 APM-500B ..... 47, 63  
 APM-500C ..... 47, 63  
 APM-500D ..... 47, 63  
 APM-500E-400 ..... 47, 63  
 APM-500E-800 ..... 47, 63  
 APM-1000B ..... 47, 63  
 APM-1000C ..... 47, 63  
 APM-1000H ..... 47, 63  
 Average Reading RF Power Meter ..... 63  
 Aviation RF Connector/Adapter Kit ..... 105

**B**

BA-300-115 ..... 91  
 BA-300-230 ..... 91  
 BA-310-115 ..... 91  
 BA-310-230 ..... 91  
 Basic Power Sensors ..... 44  
 BDS2 ..... 30  
 Bird Diagnostic System ..... 30  
 Bird RF Meter App ..... 111, 112  
 BPME Series ..... 54, 55  
 Broadcast Power Monitor ..... 54, 55

**C**

CC-6 ..... 107  
 Channel Power Monitor ..... 51  
 Coaxial Cables ..... 108  
 Coaxwich Series ..... 101  
 Conduction-Cooled RF Power Loads ..... 81  
 Convection-Cooled RF Power Attenuators ..... 92  
 Convection-Cooled RF Power Loads ..... 82  
 CPM Series ..... 51

**D**

DA5F15 ..... 89  
 DA5F30 ..... 89  
 DA5U15 ..... 89  
 DA5U30 ..... 89  
 DA10F15 ..... 89  
 DA10F30 ..... 89  
 DA10U15 ..... 89  
 DA10U30 ..... 89  
 DA10V1F15 ..... 88  
 DA10V1F30 ..... 88  
 DA10V1U15 ..... 88  
 DA10V1U30 ..... 88  
 DA10V3F15 ..... 88  
 DA10V3F30 ..... 88  
 DA10V3U15 ..... 88  
 DA10V3U30 ..... 88  
 DA15F15 ..... 89  
 DA15F30 ..... 89

DA15U15 ..... 89  
 DA15U30 ..... 89  
 DA25-4U15 ..... 89  
 DA25-4U30 ..... 89  
 DA25F15 ..... 89  
 DA25F30 ..... 89  
 DA25 to 4U15 ..... 89  
 DA25 to 4U30 ..... 89  
 DA25U15 ..... 89  
 DA25U30 ..... 89  
 DA25V3F15 ..... 88  
 DA25V3F30 ..... 88  
 DA25V3U15 ..... 88  
 DA25V3U30 ..... 88  
 DA25V4U15 ..... 88  
 DA25V4U30 ..... 88  
 DA40-5U15 ..... 89  
 DA40-5U30 ..... 89  
 DA40F15 ..... 89  
 DA40F30 ..... 89  
 DA40 to 5U15 ..... 89  
 DA40 to 5U30 ..... 89  
 DA40U30 ..... 89  
 DA Series ..... 88  
 DC-450/2700-50 Series ..... 96  
 Digital Air Loads ..... 88  
 Directional Coupler Elements ..... 73  
 Directional ThruLine Power Sensors ..... 46  
 Divider/Combiners ..... 99  
 Dollies ..... 109  
 Dual Element, Single Carrier RF Monitor/Alarm ..... 57  
 Dual Meter, Dual Element, Panel-Mount RF Wattmeters ..... 67  
 Dual Sensor Calibration Cart ..... 34

**E**

EC-1 ..... 107  
 Ethernet Power Sensors ..... 52, 53

**F**

FH-AV-BASIC ..... 18  
 FH-AV-CC ..... 107  
 FH-AV-KIT ..... 18  
 Field Replacement Meter Movement Assembly Kit ..... 69  
 Flange-to-Flange RF Adapters ..... 103  
 FlightHawk Aviation Cable & Antenna Analyzer Kit ..... 18  
 Forced Air-Cooled Moduloads ..... 90

**G**

General Purpose RF Test Kits ..... 17

**H**

High-Frequency Elements ..... 71  
 High Power Calibration Cart ..... 36

<b>I</b>			
Inline VI Probe System .....	30		
Interseries RF Adapters.....	103		
<b>L</b>			
Liquid Coolants .....	109		
Load & Cooling Accessories.....	109		
Low-Frequency Elements.....	71		
Low-Power Elements.....	70		
<b>M</b>			
Master RF Test Kits.....	16		
Milliwatt Elements .....	72		
Model 43 Series.....	60		
Model 44 Series.....	60, 61		
Model 3140A4 .....	55		
Model 3170B.....	57		
Model 4240-400 .....	104, 106		
Model 4240-401 .....	104		
Model 4240-401AV .....	105		
Model 4240-550.....	105		
Model 4240-560.....	106		
Model 4526.....	67		
Model 4527.....	67		
MSCC7 Series .....	34		
Multifunction Power Meters.....	23		
Multi-Position, RF Selector Switches .....	101		
Multipower RF Wattmeters.....	62		
<b>N</b>			
Nondirectional Sampler Elements .....	72		
<b>O</b>			
Oil Convection-Cooled RF			
Power Attenuators .....	91		
Oil-Cooled Market Specific RF Loads.....	86		
Oil-Cooled RF Loads .....	84		
<b>P</b>			
PA-F4.3F4.3 .....	106		
PA-F4.3M4.3-R.....	106		
PA-FNF4.3 .....	106		
PA-FNM4.3.....	106		
PA-MNF4.3.....	106		
PA-MNM4.3 .....	106		
PD-138/960-50 Series .....	97		
PD-380/2700-200-3 .....	96		
PD-450/2700-300 Series .....	97		
PEP-Dual Element, RF Power Analyst .....	64		
Plug-In Elements.....	70-72, 74, 75		
Portable ThruLine Wattmeters.....	60		
Power Dividers.....	97		
Power Tappers .....	98		
Precision Directional RF			
Power Sensors .....	26		
Precision Filtered RF Power Sensors .....	27		
Precision RF Power Sensors .....	24, 25		
Precision RF Products.....	20		
Protective Cases.....	107		
Pulse-Power Elements .....	72		
<b>Q</b>			
QC Series.....	102		
QC Series, RF Adapters .....	103		
Quick-Change Solderless RF Connectors .....	102		
<b>R</b>			
RailHawk Railway Cable &			
Antenna Analyzer Kit .....	19		
Replacement Meter Movement Face .....	69		
Replacement Resistors .....	109		
RF Analyzers .....	10		
RF Calibration Kit.....	37		
RF Coaxial Cables.....	108		
RF Connector/Adapter Kit.....	104, 106		
RF Couplers.....	96		
RF Coupling Kits.....	103		
RF Directional ThruLine			
Power Sensors .....	28, 29		
RF Interseries Adapter Kit with SMA.....	104		
RF Loads & Attenuators.....	76		
RF Power Meter Display .....	41		
RF Power Meters .....	58		
RF Power Monitors.....	48		
RF Power Sensors .....	38		
RF Wattmeter Movement Kit.....	69		
RH-RR-KIT .....	19		
Rigid Line Sections.....	68		
Rigid Line Wattmeters .....	65, 66		
RPK5-898-2 .....	109		
RPK5-898-3 .....	109		
RPK5-898-6 .....	109		
RPK5A2388 .....	109		
RPK43-4.....	69		
RPK2080-002 .....	69		
RPK6770A120 .....	109		
RPK8738A072 .....	109		
RPK8755-027-2.....	109		
RPK8755-027-3 .....	109		
RPK8755-027-4 .....	109		
RPK8755-027-5 .....	109		
RPK8792-010-1 .....	109		
<b>S</b>			
SCC7 Series .....	32		
SCC8 Series .....	36		
SH-60S-AOA.....	15		
SH-60S-TC.....	15		
SignalHawk Spectrum Analyzers.....	15		
Single Carrier RF Monitors/Alarms.....	56		
Single Sensor Calibration Cart.....	32		
SiteHawk Cable & Antenna Analyzers.....	14		
SK-4500-TC.....	14		
SK-6000-TC.....	14		
SK-SH-KIT .....	16		
SMK-3000 Series .....	37		
SMK-3003-HB .....	37		
SMK-3003-LB.....	37		
SMK-3003-MB .....	37		
Software.....	110		
Statistical Power Sensor.....	45		
<b>T</b>			
Thermoswitches for Air-Cooled Loads .....	109		
ThruLine Wattmeter Components .....	68		
TP-138/960-200-3.....	98		
TP-138/960-200-6.....	98		
TP-138/960-200-10 .....	98		
TP-138/960-200-15 .....	98		
TP-138/960-200-20 .....	98		
TP-138/960-200 Series.....	98		
Transmitter RF Power Monitor Display .....	55		
<b>V</b>			
Variable RF Signal Samplers .....	100		
Virtual RF Power Meter Software.....	111		
VPM3.....	111		
<b>W</b>			
Water-Cooled Accessories.....	109		
Water-Cooled Econoloads.....	87		
Water-Cooled Load Accessories.....	109		
Wideband Power Sensors.....	42		







Since 1942, Bird has been developing and manufacturing cutting-edge, high power RF sensors, test equipment, and RF coverage products that engineers, field techs, and manufacturers worldwide, rely on for accuracy, precision, and dependability. Bird continues to innovate precision and performance products for public safety, cellular, semiconductor, military, aviation, broadcast, and medical markets.

The past 80 years have brought many changes. However, Bird remains as committed today as we were in 1942 to a continuous improvement culture, innovative products that please our customers, and a dedication to advancing RF for tomorrow's applications.

The **RF** Experts | USA Sales: 30303 Aurora Rd, Solon, OH 44139 | [www.birdrf.com](http://www.birdrf.com)  
Phone: +1 440.248.1200 / 866.695.4569 [Toll Free]

Bird is not responsible for omissions or errors. Specifications subject to change without notice.  
©2024 Bird ■ Test-Measurement-Catalog-02082024

